

Wood Veneer Desking + Tables

Effective January 2017



PRICE LIST
wood veneer



think global

THE GLOBAL EDGE

ERGONOMICS IN THE TOTAL OFFICE

- One stop shopping for a full range of office furniture.
- Seating, desks, tables, files, modular furniture, panels and accessories.
- Ergonomics, competitive pricing and built-in value.

STRENGTH AND STABILITY

- Established in 1966.
- One of North America's largest office furniture manufacturers.
- Manufacturing and showrooms worldwide.

QUICK SHIP - INSTOCK

- Hundreds of products in stock for immediate delivery.

STRONG LOCAL REPRESENTATION

- Service and expert advice where you are, when you need it!

MANUFACTURING CAPABILITY

- Vertical integration ensures "start to finish" control.
- Ongoing research and investment in new, innovative production technology.

QUALITY ASSURANCE

- Quality Assurance Program is qualified by C.G.S.B. ISO9001 standards.
- On-site furniture testing facility.
- Product and components are tested to ANSI/BIFMA standards.

ENVIRONMENTAL COMMITMENT

- Continuous development of "earth friendly" programs.
- One of the first molded foam manufacturers to create ozone-friendly, CFC and HFC-free process.
- Seat and back pans are made from recyclable plastics and wood waste, enabling little waste and cost effective products.

SYMBOL IDENTIFICATION



Global's Certified Products are in compliance with the stringent emission guidelines set by the GREENGUARD Environmental Institute and include all Upholstered Seating. To obtain a GREENGUARD Certificate for any product, please go to the product page on our website www.globaltotaloffice.com and click on "View GREENGUARD Certificate".



level™ certification, based on the ANSI/BIFMA e3-2012 furniture sustainability standard, sets furniture manufacturers on a path toward greater sustainability over time. Based on environmental and social criteria set forth in the standard, a product's entire supply chain is assessed.



Certification assessment includes an evaluation of specific corporate policies and guidelines and an assessment of associated company manufacturing facilities. Products must meet quantifiable milestones of environmental and social performance at every step of development.

The quantitative assessment addresses four categories: material use, energy and atmosphere impacts, human and ecosystem health and social responsibility.

Manufacturers earn points in each of the four categories. The level™ brand and its numeric rating of 1, 2 or 3 indicate what threshold of certification a product has achieved. level™ 3 is the highest rating.

TABLE OF CONTENTS

WOOD VENEER DESKS

Dufferin	4-78
Lufton	80-128

WOOD VENEER TABLES

Boardroom Tables	130-152
------------------------	---------

REFERENCE

Terms/Conditions/Warranty	162-165
Textiles & Finishes	154-161
Index	166-

WOOD VENEER DESK NOTES

The following applies to all VENEER Series - Dufferin and Lufton (unless otherwise noted).

CONSTRUCTION:

- "Number one select, architectural grade A" oak, American black walnut, American black cherry, and hard maple. Wood worksurface moulded edges are solid oak, walnut, cherry, or maple (except where square self-edges exist, i.e. credenza and computer worksurface back edges that are most commonly against walls).

FINISH:

- Conversion varnish (similar to catalyzed lacquer, but tougher), 25 degree sheen. Finishes are not buffed or rubbed.
- All Global wood casegood products are veneered and finished on the back sides (360 degree finishing), except modular under-surface storage - tops and backs are unfinished.

PEDESTALS:

- Pedestals are fully assembled units. Undersurface storage units provide standard locks.
- All drawers are standard as vinyl-wrapped black embossed with V-groove construction.
- Drawers are "5-sided". The drawer front is an applied element to a four-sided drawer. Drawer fronts can be removed or replaced in the field.
- Pedestal drawers and lateral file drawers are supported by steel ball bearing suspensions. All suspensions carry a full lifetime warranty against defects.
- All drawers have full extension.

HARDWARE:

- All necessary hardware items for attaching furniture items are included in the shipment. Actual wall attachment fasteners for wall cabinets, tackboards and visualboards are not included due to variation between site conditions.
- **Leveling glides** are shipped installed on the unit. Levelers have a 1" range of adjustment.
- **Hanging file rails** are pre-installed on file drawer perimeters with additional front-to-back rails found in the bottom of the filing drawers. These rails hang onto plastic clips and do not require any tools to install. The back rail in a lateral file drawer is designed for both legal and letter size filing. To adjust back rail, simply install the rail to the pre-drilled holes accordingly.
- **Flat plates** for attaching bridge and return to desk are shipped pre-attached to the bottom of the bridge or return. **Mini flat plates** for securing bridge modesty panels to desk or credenza end panels, and **quick connectors** for securing modular corner units to adjacent pieces (Dufferin Series) are shipped along with screws in a plastic bag attached to the bottom of the bridge or return. CAUTION: using screws other than those supplied by Global could result in damage to finished tops.

INSTALLATION:

Wall-mounted cabinets and visual boards are pre-attached with horizontal wall rails to the back of each unit. The wall-side components need to be detached from the unit and fastened to the wall accordingly. Wall fasteners are not included due to variation between site conditions. Securing the wall rail to a vertical structural member is the required manner of installation. The cabinet or visualboard is then lowered on to the wall rail. It is important to level the wall rail before installation. Wall cabinets are equipped with levelers at the bottoms of the side panels for proper cabinet alignment. It is recommended to use a single drywall screw through the back of the cabinet and the wall-mounted rail, to further secure the wall attachment.

Wall-mounted tackboards have vertical grooves in the back for tasklight wiring. Horizontal wall rails are provided. Fasteners are not included due to variation between site conditions. The site installer need to position the wall rail and determine the type of screw to be used for the application. The tackboard is hung on the wall rail. Using a level will also aid in the tackboard installation.

Hutches are installed with double-faced tape applied on the bottom of the end panels. Global utilizes a non-marring method of hutch attachment. The tape is shipped in a plastic bag found in the hutch. Removal of the hutch requires moderate pressure to be applied on the top of the unit towards the wall for at least a minute for the pressure-sensitive tape to release. At the dealer or installer's discretion, additional support may be added by installing flat plates along the back of the attached units. These flat plates are not included in the shipment.

Hutch tackboards are factory installed.

Modular storage units have pre-drilled holes through the tops for securing to the bottom of the worksurfaces. Disassemble the modular unit first before relocating the entire unit to avoid damage or body injuries.

5-Sided corner tables and adjoining bridge and credenza run-offs are attached with MP-53 mending plates. Accurate leveling is critical for these units to align and connect properly.

NOTE: Leveling wood office furniture properly is the most important procedure to ensure proper functioning and alignment of drawers, locks and doors. Upon completing installation, wipe furniture with a damp cloth, followed with a dry soft cloth - always in the direction of the grain.

dufferin





The **Dufferin** series is a unique entity in that it integrates wood veneer and laminate. Worksurfaces, drawer and cabinet fronts use genuine wood veneer while the chassis and cabinets are finished in your choice of laminate or wood veneer. The result is a rich, two tone appearance to coordinate with any contemporary business interior.

Key features include a two inch knife edge providing clean, crisp detailing, grommets, a reverse profile/self edge edge on connecting worksurfaces, square or round post leg on islands, base and modesty panel upgrades and endless electrical options.

Storage options are available in 29", 48", 54", 66", 72" and 84" heights. Various models include storage cabinets, file modules, mixed storage cabinets, open shelving, wardrobe cabinets and personal towers.

Above worksurface storage selections include overhead storage and hutches with or without pigeon-hole storage. Hutch doors are available in a choice of veneer or glass with an aluminum frame. Tackboards are offered in all fabric or with a built-in accessory rail for organizing folders, binders, cds and more!



Contemporary **two inch overhang knife edge** on user and guest sides. Self-edge veneer on ends and wall sides.



Optional **base upgrades** include a rectangular two tone base (shown) and elliptical base. Available on most islands.

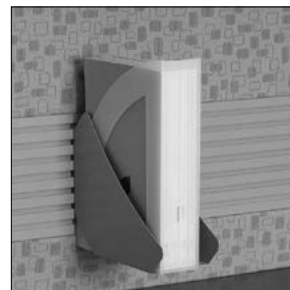

Tackboards with **accessory rails** accommodate letter trays, binder bins and file holders.



Features and Benefits

- Choice of ten handle options on every door/drawer that features handles
- Modesty panel options include metal in Black or Tungsten and veneer
- Base upgrades to replace standard monopost on islands are available in four styles
- Drawers are standard vinyl-wrapped construction with black drawer sides and bottom.
- 75 lb box - 150 lb. file drawer weight capacity with full height sides with pencil tray included in box drawer
- Lateral file drawers can accommodate legal or letter documents
- Premium full extension progressive ball bearing slides on file drawers
- Box drawers mounted on 3/4 extension premium ball bearing slides.
- Power / Data accessories are available to be factory installed on any Dufferin unit, including Boardroom Tables, to meet all today's technological requirements
- A full array of complementary Boardroom and Reception area furnishings are available to coordinate the entire office

GENERAL INFORMATION

- Dufferin is a veneer and laminate desking system composed of hundreds of models, capable of furnishing executive suites, boardrooms and reception areas.
- 1 3/16" thick worksurfaces utilizing pedestal and panel construction with top over side panel design.
- Full modesty panels on desks are available in either a straight or breakfront style
- Global desking products are in compliance with stringent emission guidelines set out by the Greenguard Environmental Institute under the standards for low emitting products and materials. www.greenguard.org
- **Level 2 Certified**

WORKSURFACES

- Standard with 1 3/16" top thickness
- All surfaces constructed from grade "A" veneers
- All top surfaces feature a contemporary 2" overhang knife edge on user and guest sides. Self-edge veneer on ends and wall sides.

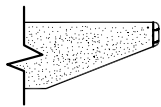

Contemporary 2" overhanging knife edge

CONSTRUCTION

- "Number one select, architectural grade A" oak, American black walnut, American black cherry, hard maple and lyptus. Wood worksurface moulded edges are solid oak, walnut, cherry, maple or lyptus (except where square self-edges exist, i.e. credenza and computer worksurface back edges that are most commonly against walls).

FINISHES

- Conversion varnish (similar to catalyzed lacquer, but tougher), 35 to 40 degree sheen. Finishes are not buffed or rubbed.
- All Global wood casegood products are veneered and finished on the back sides (3600 finishing), except modular under-surface storage - tops and backs are unfinished.
- Global standard finish, on oak and walnut, is open pore and on cherry and maple is semi-closed pore. If a full finish is required for walnut, cherry, anigre and maple tops, Add the suffix "2" to the finish code and Add 5% to the base pricing for each product.

CUSTOM FINISH IS AVAILABLE.

PEDESTALS

- Black embossed vinyl-wrapped construction drawer sides and bottom are standard.
- All pedestals are full to floor and locking.
- Double pedestal models feature a choice of four drawer configurations: two file/file pedestals (EE), two box/box/file pedestals (DD), file/file on left, box/box/file on right (ED), or file/file on right, box/box/file on left (DE).
- Single pedestal models feature a choice of two drawer configurations: one file/file pedestal (E) or one box/box/file pedestal (D) on the left or right.

HARDWARE

- All necessary hardware items for attaching furniture items are included in the shipment. Actual wall attachment fasteners for wall cabinets, tackboards and visualboards are not included due to variation between site conditions.
- **Leveling glides** are shipped in a plastic bag attached to the bottom of the item or inside the pedestal. It is important to install leveling glides to ensure the unit is level. Levelers have a 1" range of adjustment.
- **Hanging file rails** are pre-installed on file drawer perimeters with additional front-to-back rails found in the bottom of the filing drawers. These rails hang onto plastic clips and do not require any tools to install. The back rail in a lateral file drawer is designed for both legal and letter size filing. To adjust back rail, simply install the rail to the pre-drilled holes accordingly.

- **Flat plates** for attaching bridge and return to desk are shipped pre-attached to the bottom of the bridge or return. **Mini flat plates** for securing bridge modesty panels to desk or credenza end panels, and quick connectors for securing modular corner units to adjacent pieces (Dufferin Series) are shipped along with screws in a plastic bag attached to the bottom of the bridge or return. **CAUTION:** using screws other than those supplied by Global could result in damage to finished tops.

LOCKS

- Locks are standard on all "below worksurface level" drawer and door storage units with the exception of the stationary organizer, pull-out tray units and single lateral file drawer combination tray/slot units. Combination storage unit comes with lock for file and lateral file drawer only, box drawers cannot lock.
- Optional locks may be ordered on all "above worksurface level" closed storage, Factory Installed. Please specify **LO, ADD 88.00.**

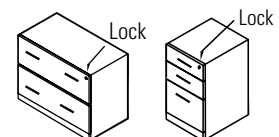
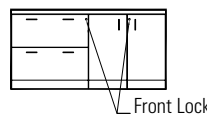
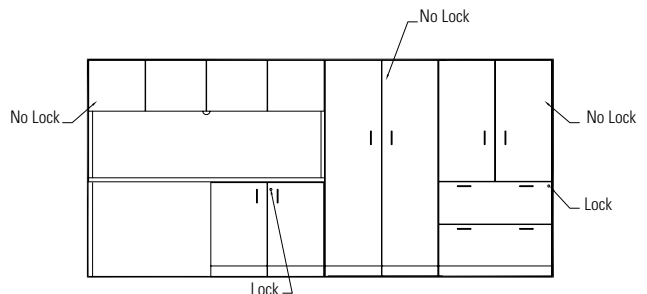

DCF7224

Style Credenza: File lock is on the inside gable behind the bookcase door. Lock for doors is on the front.

DWF

Modular Furniture: Lock is on the front

DWD

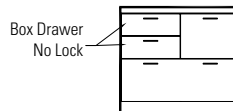

DZ3622

Combination storage unit Z comes with lock for file and lateral file drawer only, box drawers cannot lock.

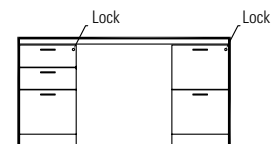

DD7236DE

Fully assembled furniture: Lock for D and E pedestals are inside the gable.

D DUFFERIN - NOTES

1. SPECIFY MODEL NUMBER

2. SPECIFY FINISH

WORKSURFACE TOP & DRAWER/DOOR FRONTS, BODY FINISHES (INCLUDING PEDESTALS) - VENEER

Code	Finish	Veneer Type	Cut
AMW	Almond Cherry	Cherry	Flat Sliced
BAMC	Caramel Bamboo	Bamboo	Narrow
CAW	Cocoa Walnut	Walnut	Flat Sliced
CRW	Coral	White Oak	Rift
DCW	Dark Cherry	Cherry	Flat Sliced
EWV	Espresso Walnut	Walnut	Flat Sliced
EVW	Evening Oak	White Oak	Rift
GRW	Grey on Oak	White Oak	Rift
HAW	Hazelnut	Maple	Flat Sliced
SMW	Honey Maple	Maple	Flat Sliced
JAW	Java	White Oak	Rift
LTW	Latte Walnut	Walnut	Flat Sliced
MTW	Milestone	White Oak	Rift
MCW	Mocha	White Oak	Rift
MPW	Natural Maple	Maple	Flat Sliced
RCW	Red Cherry	Cherry	Flat Sliced
VNW	Vintage Cherry	Cherry	Flat Sliced
WLW	Walnut	Walnut	Flat Sliced
WCW	Warm Cherry	Cherry	Flat Sliced
WMW	White Maple	Maple	Flat Sliced

BODY FINISHES (INCLUDING PEDESTALS) - LAMINATE:

BLK	Black
CGY	Custom Grey
HGT	Hayden Grey
STG	String
SOG	Storm Grey
WHT	White

MONOPOST FINISHES:

E	Black
K	Tungsten

3. SPECIFY OPTIONS

Handles

- Handles are standard on most drawers/storage modules. Each handle is identified by letters "PL33", "PL34", "PLS7", "PLS8", "PL74", "PL75", "PL64", "PL67", "PL65" and "PL66". To specify a handle, please specify the code after the model number and veneer & laminate selections.



PL33 Black Moon Pull, 4"



PL34 Nickel Moon Pull, 4"



PLS7 Black Spaghetti, 7 3/8"



PLS8 Silver Spaghetti, 7 3/8"



PL74 Tungsten Pull, 5/4"
DK67 (On uppers)



PL75 Silver Wedge Pull, 3 5/16"



PL64 Nickel Pull, 5 3/8"



PL67 Tungsten Pull, 5 3/8"



PL65 Nickel Pull, 6 1/2"



PL66 Nickel Square Edge, 6 1/2"

Grommets

- Standard grommet on all components is GM1. Grommet is included with products where shown in line drawings in price book.
- Optional grommets may be ordered in standard worksurface locations (left, center or right). Order as **GM1TL**, **GM1TC** or **GM1TR**. **ADD 69.00.**
- Grommet hole dimensions are 2 3/4" in diameter. Specify **GM1E** for **Black** or **GM1K** for **Tungsten**.
- Color of grommet will be automatically coordinated with handle color where applicable

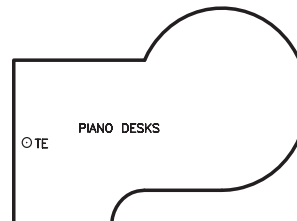
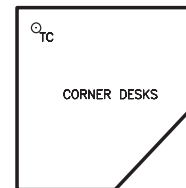
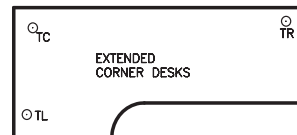
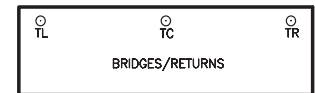
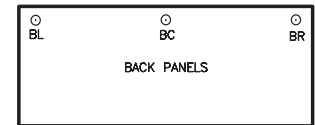
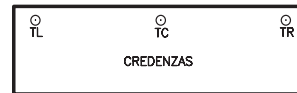
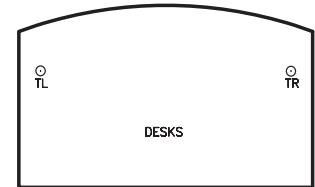
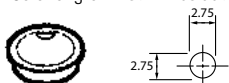

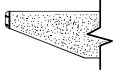

● Molding Edge

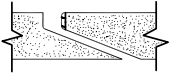

■ Reverse Profile / Molding Edge



▼ Self Edge Joint

- D - Desks and Credenzas
- B - Executive Bridges
- E - Executive Returns
- C - Corner Components
- L - Linking Bridges
- P - Piano Desks

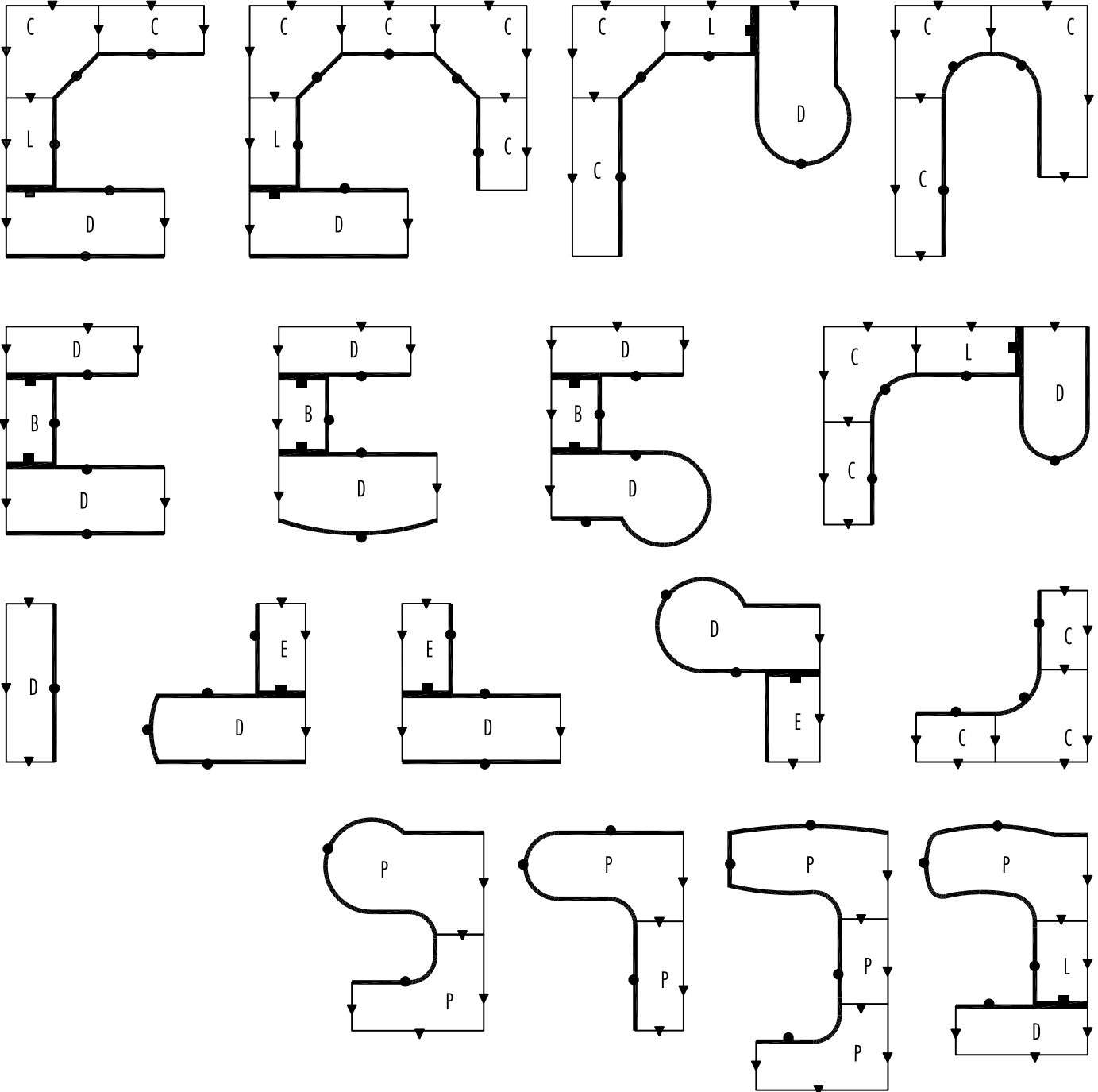

D DUFFERIN

DOUBLE PEDESTAL DESKS

MODEL#

DIMENSIONS

FREIGHT CLASS

WT/LBS.

CUBIC FT.

VENEER/LAMINATE

ALL VENEER

D x W x H

- Can be ordered as a shell or with pedestals.
- Grommets are available an option on Desks and most Credenzas.
- Hand of Rectangular Desk is determined by location of pedestal from user side.
- Hand of "P" Top is determined by outward orientation of conference end from user projection.

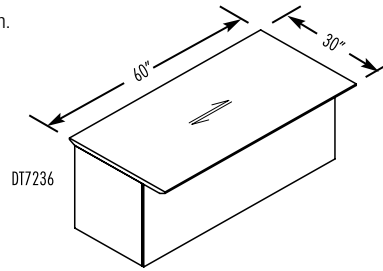
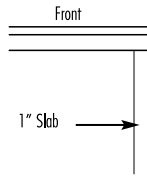
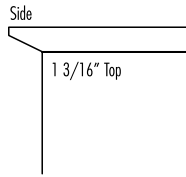
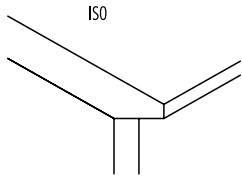

MODESTY PANEL CLEARANCE:

DT7236

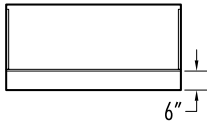

DT7230

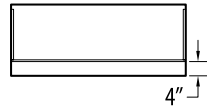

DMT7242

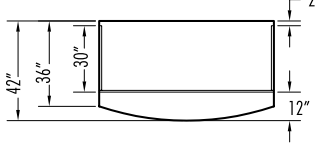

DMT6636



DISR8442D

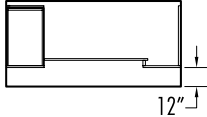

DISR7230D

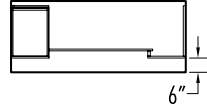

DDD7236



DDDBE7236



DDDBS7236



DTPL7242 (left shown)

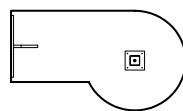

DESK MODESTY OPTIONS:

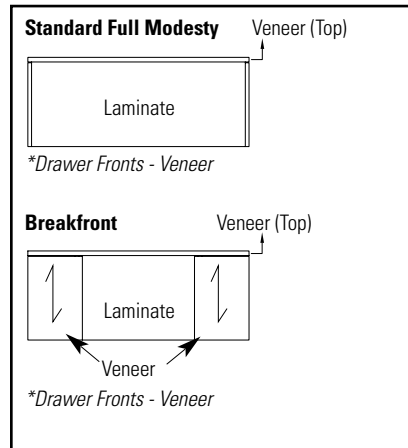

Breakfront Style - Modesty

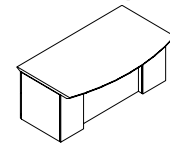

view from guest side

Standard Full Modesty

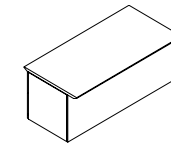

view from guest side

DOUBLE PEDESTAL DESKS - RECESSED FRONT MODESTY

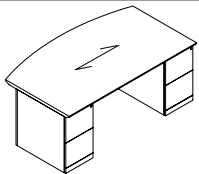

Double Pedestal Bow Top Desk

DMD8442EE	42 x 84 x 29	125	443	59	\$4149	\$4979
DMD7842EE	42 x 78 x 29	125	412	55	\$3850	\$4620
DMD7242EE	42 x 72 x 29	125	380	51	\$3555	\$4266
DMD6636EE	36 x 66 x 29	125	240	40	\$3448	\$4138

Standard with full to floor **file/file** pedestals on **left and right**. Bow top. Pedestals lock. Refer to the Desks and Credenzas Notes above for overhang dimensions.

Required Specifications

Veneer Finish
Laminate Finish
Handle Style

Optional Specifications

Grommet

DOUBLE PEDESTAL DESKS

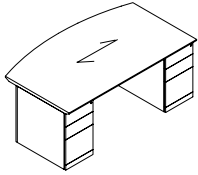

Double Pedestal Bow Top Desk

MODEL#	DIMENSIONS D x W x H	FREIGHT CLASS	WT./LBS.	CUBIC FT.	veneER/LAMINATE	ALL veneER
DMD8442DD	42 x 84 x 29	125	443	59	\$4149	\$4979
DMD7842DD	42 x 78 x 29	125	412	55	\$3850	\$4620
DMD7242DD	42 x 72 x 29	125	380	51	\$3555	\$4266
DMD6636DD	36 x 66 x 29	125	240	40	\$3448	\$4138

Standard with full to floor **box/box/file** pedestals on **left** and **right**. Bow top. Pedestals lock. One pencil tray. Refer to the Desks and Credenzas Notes Section on previous page for overhang dimensions.

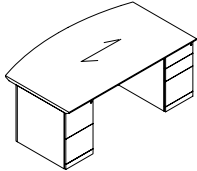

Double Pedestal Bow Top Desk

DMD8442ED	42 x 84 x 29	125	443	59	\$4149	\$4979
DMD7842ED	42 x 78 x 29	125	412	55	\$3850	\$4620
DMD7242ED	42 x 72 x 29	125	380	51	\$3555	\$4266
DMD6636ED	36 x 66 x 29	125	240	40	\$3448	\$4138

Standard with full to floor **file/file** pedestal on **left** and **box/box/file** pedestal on **right**. Bow top. Pedestals lock. One pencil tray. Refer to the Desks and Credenzas Notes Section on previous page for overhang dimensions.

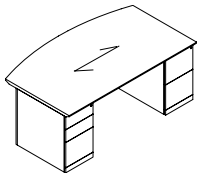

Double Pedestal Bow Top Desk

DMD8442DE	42 x 84 x 29	125	443	59	\$4149	\$4979
DMD7842DE	42 x 78 x 29	125	412	55	\$3850	\$4620
DMD7242DE	42 x 72 x 29	125	380	51	\$3555	\$4266
DMD6636DE	36 x 66 x 29	125	240	40	\$3448	\$4138

Standard with full to floor **box/box/file** pedestal on **left** and **file/file** pedestal on **right**. Bow top. Pedestals lock. One pencil tray. Refer to the Desks and Credenzas Notes Section on previous page for overhang dimensions.

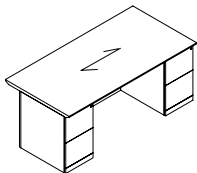

Double Pedestal Desk

DD8442EE	42 x 84 x 29	125	432	59	\$3526	\$4232
DD7842EE	42 x 78 x 29	125	401	55	\$3275	\$3930
DD7236EE	36 x 72 x 29	100	370	44	\$3023	\$3628
DD7230EE	30 x 72 x 29	100	349	36	\$2976	\$3572
DD6636EE	36 x 66 x 29	100	339	40	\$2976	\$3572
DD6630EE	30 x 66 x 29	100	320	33	\$2929	\$3515
DD6030EE	30 x 60 x 29	92.5	305	30	\$2837	\$3405

Standard with full to floor **file/file** pedestals on **left** and **right**. Pedestals lock. Refer to the Desks and Credenzas Notes Section on previous page for overhang dimensions.

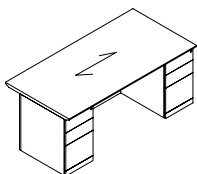

Double Pedestal Desk

DD8442DD	42 x 84 x 29	125	432	59	\$3526	\$4232
DD7842DD	42 x 78 x 29	125	401	55	\$3275	\$3930
DD7236DD	36 x 72 x 29	100	370	44	\$3023	\$3628
DD7230DD	30 x 72 x 29	100	349	36	\$2976	\$3572
DD6636DD	36 x 66 x 29	100	339	40	\$2976	\$3572
DD6630DD	30 x 66 x 29	100	320	33	\$2929	\$3515
DD6030DD	30 x 60 x 29	92.5	305	30	\$2837	\$3405

Standard with full to floor **box/box/file** pedestals on **left** and **right**. Pedestals lock. Refer to the Desks and Credenzas Notes Section on previous page for overhang dimensions.

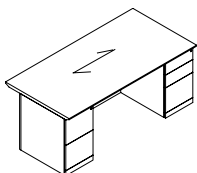

Double Pedestal Desk

DD8442ED	42 x 84 x 29	125	432	59	\$3526	\$4232
DD7842ED	42 x 78 x 29	125	401	55	\$3275	\$3930
DD7236ED	36 x 72 x 29	100	370	44	\$3023	\$3628
DD7230ED	30 x 72 x 29	100	349	36	\$2976	\$3572
DD6636ED	36 x 66 x 29	100	339	40	\$2976	\$3572
DD6630ED	30 x 66 x 29	100	320	33	\$2929	\$3515
DD6030ED	30 x 60 x 29	92.5	305	30	\$2837	\$3405

Standard with full to floor **file/file** pedestal on **left** and **box/box/file** pedestal on **right**. Pedestals lock. Refer to the Desks and Credenzas Notes Section on previous page for overhang dimensions.

Required Specifications

Veneer Finish
Laminate Finish
Handle Style

Optional Specifications

Grommet

D DUFFERIN

DOUBLE PEDESTAL DESKS

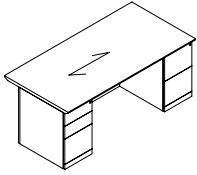

Double Pedestal Desk

MODEL#	DIMENSIONS D x W x H	FREIGHT CLASS	WT/LBS.	CUBIC FT.	VENEER/LAMINATE	ALL VENEER
DD8442DE	42 x 84 x 29	125	432	59	\$3526	\$4232
DD7842DE	42 x 78 x 29	125	401	55	\$3275	\$3930
DD7236DE	36 x 72 x 29	100	370	44	\$3023	\$3628
DD7230DE	30 x 72 x 29	100	349	36	\$2976	\$3572
DD6636DE	36 x 66 x 29	100	339	40	\$2976	\$3572
DD6630DE	30 x 66 x 29	100	320	33	\$2929	\$3515
DD6030DE	30 x 60 x 29	92.5	305	30	\$2837	\$3405

Standard with full to floor **box/box/file** pedestal on **left** and **file/file** pedestal on **right**. Pedestals lock. Refer to the Desks and Credenzas Notes Section on page 10 for overhang dimensions.

DOUBLE PEDESTAL DESKS - BREAKFRONT STYLE

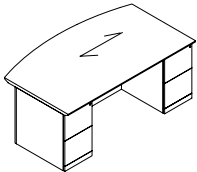

**Double Pedestal Bow Top Desk
Breakfront Style**

DMID8442EE	42 x 84 x 29	125	443	59	\$4925	\$5910
DMID7842EE	42 x 78 x 29	125	412	55	\$4572	\$5487
DMID7242EE	42 x 72 x 29	125	380	51	\$4221	\$5066
DMID6636EE	36 x 66 x 29	125	240	40	\$3795	\$4554

Standard with full to floor **file/file** pedestals on **left** and **right**. Bow top. Pedestals lock. Refer to the Desks and Credenzas Notes Section on page 10. for overhang dimensions.

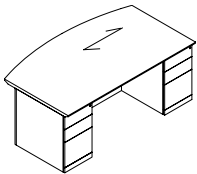

**Double Pedestal Bow Top Desk
Breakfront Style**

DMID8442DD	42 x 84 x 29	125	443	59	\$4925	\$5910
DMID7842DD	42 x 78 x 29	125	412	55	\$4572	\$5487
DMID7242DD	42 x 72 x 29	125	380	51	\$4221	\$5066
DMID6636DD	36 x 66 x 29	125	240	40	\$3795	\$4554

Standard with full to floor **box/box/file** pedestals on **left** and **right**. Bow top. Pedestals lock. Refer to the Desks and Credenzas Notes Section on page 10. for overhang dimensions.

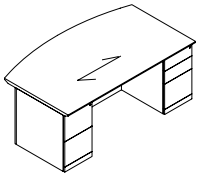

**Double Pedestal Bow Top Desk
Breakfront Style**

DMID8442ED	42 x 84 x 29	125	443	59	\$4925	\$5910
DMID7842ED	42 x 78 x 29	125	412	55	\$4572	\$5487
DMID7242ED	42 x 72 x 29	125	380	51	\$4221	\$5066
DMID6636ED	36 x 66 x 29	125	240	40	\$3795	\$4554

Standard with full to floor **file/file** pedestal on **left** and **box/box/file** pedestal on **right**. Bow top. Pedestals lock. One pencil tray. Refer to the Desks and Credenzas Notes Section on page 10 for overhang dimensions.

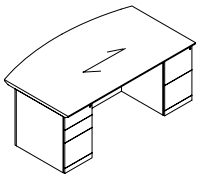

**Double Pedestal Bow Top Desk
Breakfront Style**

DMID8442DE	42 x 84 x 29	125	443	59	\$4925	\$5910
DMID7842DE	42 x 78 x 29	125	412	55	\$4572	\$5487
DMID7242DE	42 x 72 x 29	125	380	51	\$4443	\$5332
DMID6636DE	36 x 66 x 29	125	240	40	\$3795	\$4554

Standard with full to floor **box/box/file** pedestal on **left** and **file/file** pedestal on **right**. Bow top. Pedestals lock. One pencil tray. Refer to the Desks and Credenzas Notes Section on page 10 for overhang dimensions.

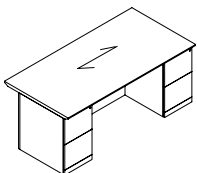

Double Pedestal Desk, Breakfront Style

DID8442EE	42 x 84 x 29	125	432	59	\$4844	\$5813
DID7842EE	42 x 78 x 29	125	401	55	\$4496	\$5396
DID7236EE	36 x 72 x 29	100	370	44	\$3590	\$4308
DID7230EE	30 x 72 x 29	100	349	36	\$3535	\$4242
DID6636EE	36 x 66 x 29	100	339	40	\$3535	\$4242
DID6630EE	30 x 66 x 29	100	320	33	\$3479	\$4175
DID6030EE	30 x 60 x 29	92.5	305	30	\$3369	\$4043

Standard with full to floor **file/file** pedestals on **left** and **right**. Pedestals lock. Refer to the Desks and Credenzas Notes Section on page 10 for overhang dimensions.

Required Specifications

Veneer Finish
Laminate Finish
Handle Style

Optional Specifications

Grommet

DOUBLE PEDESTAL DESKS - BREAKFRONT STYLE

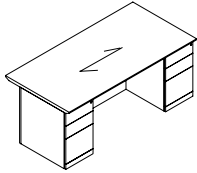

Double Pedestal Desk, Breakfront Style

MODEL#	DIMENSIONS D x W x H	FREIGHT CLASS	WT/LBS.	CUBIC FT.	veneer/LAMINATE	ALL VENEER
DID8442DD	42 x 84 x 29	125	432	59	\$4844	\$5813
DID7842DD	42 x 78 x 29	125	401	55	\$4496	\$5396
DID7236DD	36 x 72 x 29	100	370	44	\$3590	\$4308
DID7230DD	30 x 72 x 29	100	349	36	\$3535	\$4242
DID6636DD	36 x 66 x 29	100	339	40	\$3535	\$4242
DID6630DD	30 x 66 x 29	100	320	33	\$3479	\$4175
DID6030DD	30 x 60 x 29	92.5	305	30	\$3369	\$4043

Standard with full to floor **box/box/file** pedestals on **left and right**. Pedestals lock. Refer to the Desks and Credenzas Notes Section on page 10 for overhang dimensions.

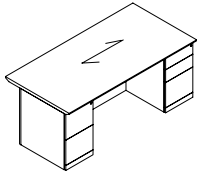

Double Pedestal Desk, Breakfront Style

DID8442ED	42 x 84 x 29	125	432	59	\$4844	\$5813
DID7842ED	42 x 78 x 29	125	401	55	\$4496	\$5396
DID7236ED	36 x 72 x 29	100	370	44	\$3590	\$4308
DID7230ED	30 x 72 x 29	100	349	36	\$3535	\$4242
DID6636ED	36 x 66 x 29	100	339	40	\$3590	\$4308
DID6630ED	30 x 66 x 29	100	320	33	\$3479	\$4175
DID6030ED	30 x 60 x 29	92.5	305	30	\$3369	\$4043

Standard with full to floor **file/file** pedestal on **left** and **box/box/file** pedestal on **right**. Pedestals lock. Refer to the Desks and Credenzas Notes Section on page 10 for overhang dimensions.

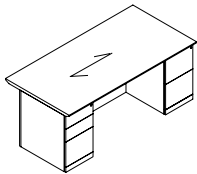

Double Pedestal Desk, Breakfront Style

DID8442DE	42 x 84 x 29	125	432	59	\$4844	\$5813
DID7842DE	42 x 78 x 29	125	401	55	\$4496	\$5396
DID7236DE	36 x 72 x 29	100	370	44	\$3590	\$4308
DID7230DE	30 x 72 x 29	100	349	36	\$3535	\$4242
DID6636DE	36 x 66 x 29	100	339	40	\$3535	\$4242
DID6630DE	30 x 66 x 29	100	320	33	\$3479	\$4175
DID6030DE	30 x 60 x 29	92.5	305	30	\$3369	\$4043

Standard with full to floor **box/box/file** pedestal on **left** and **file/file** pedestal on **right**. Pedestals lock. Refer to the Desks and Credenzas Notes Section on page 10 for overhang dimensions.

SINGLE PEDESTAL DESKS - RECESSED FRONT MODESTY

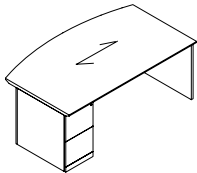

Single Pedestal Bow Top Desk - LEFT

DMSL8442E	42 x 84 x 29	125	432	59	\$3902	\$4683
DMSL7842E	42 x 78 x 29	125	401	55	\$3626	\$4352
DMSL7242E	42 x 72 x 29	125	370	51	\$3347	\$4017
DMSL6636E	36 x 66 x 29	150	230	40	\$3219	\$3863

Standard with full to floor **file/file** pedestal on **left**. Bow top. Pedestal locks. Refer to the Desks and Credenzas Notes Section on page 10 for overhang dimensions.

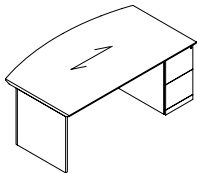

Single Pedestal Bow Top Desk - RIGHT

DMSR8442E	42 x 84 x 29	125	432	59	\$3902	\$4683
DMSR7842E	42 x 78 x 29	125	401	55	\$3626	\$4352
DMSR7242E	42 x 72 x 29	125	370	51	\$3347	\$4017
DMSR6636E	36 x 66 x 29	150	230	40	\$3219	\$3863

Standard with full to floor **file/file** pedestal on **right**. Bow top. Pedestal locks. Refer to the Desks and Credenzas Notes Section on page 10 for overhang dimensions.

Required Specifications

Veneer Finish
Laminate Finish
Handle Style

Optional Specifications

Grommet

D DUFFERIN

SINGLE PEDESTAL DESKS

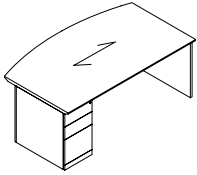

Single Pedestal Bow Top Desk - LEFT

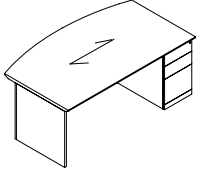

Single Pedestal Bow Top Desk - RIGHT

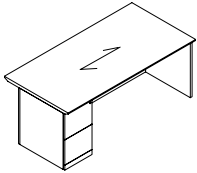

Single Pedestal Desk - LEFT

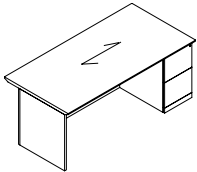

Single Pedestal Desk - RIGHT

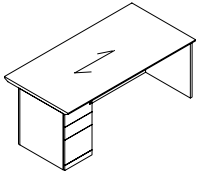

Single Pedestal Desk - LEFT

MODEL#	DIMENSIONS	FREIGHT CLASS	WT/LBS.	CUBIC FT.	veneER/LAMINATE	ALL veneER
--------	------------	---------------	---------	-----------	-----------------	------------

D x W x H

DMSL8442D	42 x 84 x 29	125	432	59	\$3902	\$4683
DMSL7842D	42 x 78 x 29	125	401	55	\$3626	\$4352
DMSL7242D	42 x 72 x 29	125	370	51	\$3347	\$4017
DMSL6636D	36 x 66 x 29	150	230	40	\$3219	\$3863

Standard with full to floor **box/box/file** pedestal on **left**. Bow top. Pedestal locks. Refer to the Desks and Credenzas Notes Section on page 10 for overhang dimensions.

DMSR8442D	42 x 84 x 29	125	432	59	\$3902	\$4683
DMSR7842D	42 x 78 x 29	125	401	55	\$3626	\$4352
DMSR7242D	42 x 72 x 29	125	370	51	\$3347	\$4017
DMSR6636D	36 x 66 x 29	150	230	40	\$3219	\$3863

Standard with full to floor **box/box/file** pedestal on **right**. Bow top. Pedestal locks. Refer to the Desks and Credenzas Notes Section on page 10 for overhang dimensions.

DSL8442E	42 x 84 x 29	125	463	59	\$3135	\$3762
DSL7842E	42 x 78 x 29	125	430	55	\$2911	\$3494
DSL7236E	36 x 72 x 29	125	340	44	\$2303	\$2764
DSL7230E	30 x 72 x 29	125	283	36	\$2202	\$2643
DSL6636E	36 x 66 x 29	125	312	40	\$2202	\$2643
DSL6630E	30 x 66 x 29	100	295	33	\$2102	\$2523
DSL6030E	30 x 60 x 29	100	265	30	\$2008	\$2410

Standard with full to floor **file/file** pedestal on **left**. Pedestal locks. Refer to the Desks and Credenzas Notes Section on page 10 for overhang dimensions.

DSR8442E	42 x 84 x 29	125	463	59	\$3135	\$3762
DSR7842E	42 x 78 x 29	125	430	55	\$2911	\$3494
DSR7236E	36 x 72 x 29	125	340	44	\$2303	\$2764
DSR7230E	30 x 72 x 29	125	283	36	\$2202	\$2643
DSR6636E	36 x 66 x 29	125	312	40	\$2202	\$2643
DSR6630E	30 x 66 x 29	100	295	33	\$2102	\$2523
DSR6030E	30 x 60 x 29	100	265	30	\$2008	\$2410

Standard with full to floor **file/file** pedestal on **right**. Pedestal locks. Refer to the Desks and Credenzas Notes Section on page 10 for overhang dimensions.

DSL8442D	42 x 84 x 29	125	463	59	\$3135	\$3762
DSL7842D	42 x 78 x 29	125	430	55	\$2911	\$3494
DSL7236D	36 x 72 x 29	125	340	44	\$2303	\$2764
DSL7230D	30 x 72 x 29	125	283	36	\$2202	\$2643
DSL6636D	36 x 66 x 29	125	312	40	\$2202	\$2643
DSL6630D	30 x 66 x 29	100	295	33	\$2102	\$2523
DSL6030D	30 x 60 x 29	100	265	30	\$2008	\$2410

Standard with full to floor **box/box/file** pedestal on **left**. Pedestal locks. Refer to the Desks and Credenzas Notes Section on page 10 for overhang dimensions.

Required Specifications

Veneer Finish
Laminate Finish
Handle Style

Optional Specifications

Grommet

SINGLE PEDESTAL DESKS

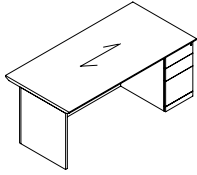

Single Pedestal Desk - RIGHT

MODEL#	DIMENSIONS	FREIGHT CLASS	WT/LBS.	CUBIC FT.	veneER/LAMINATE	ALL veneER
D x W x H						
DSR8442D	42 x 84 x 29	125	463	59	\$3135	\$3762
DSR7842D	42 x 78 x 29	125	430	55	\$2911	\$3494
DSR7236D	36 x 72 x 29	125	340	44	\$2303	\$2764
DSR7230D	30 x 72 x 29	125	283	36	\$2202	\$2643
DSR6636D	36 x 66 x 29	125	312	40	\$2202	\$2643
DSR6630D	30 x 66 x 29	100	295	33	\$2102	\$2523
DSR6030D	30 x 60 x 29	100	265	30	\$2008	\$2410

Standard with full to floor **box/box/file** pedestal on **right**. Pedestal locks. Refer to the Desks and Credenzas Notes Section on page 10 for overhang dimensions.

SINGLE PEDESTAL DESKS - BREAKFRONT STYLE

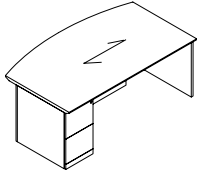

Single Pedestal Bow Top Desk - LEFT
Breakfront Style

DMISL8442E	42 x 84 x 29	125	432	59	\$3902	\$4683
DMISL7842E	42 x 78 x 29	125	401	55	\$3624	\$4349
DMISL7242E	42 x 72 x 29	125	370	51	\$3346	\$4016
DMISL6636E	36 x 66 x 29	150	230	40	\$3218	\$3862

Standard with full to floor **file/file** pedestal on **left**. Bow top. Pedestal locks. Refer to the Desks and Credenzas Notes Section on page 10 for overhang dimensions.

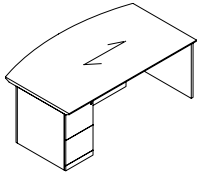

Single Pedestal Bow Top Desk - RIGHT
Breakfront Style

DMISR8442E	42 x 84 x 29	125	432	59	\$3902	\$4683
DMISR7842E	42 x 78 x 29	125	401	55	\$3624	\$4349
DMISR7242E	42 x 72 x 29	125	370	51	\$3346	\$4016
DMISR6636E	36 x 66 x 29	150	230	40	\$3218	\$3862

Standard with full to floor **file/file** pedestal on **right**. Bow top. Pedestal locks. Refer to the Desks and Credenzas Notes Section on page 10 for overhang dimensions.

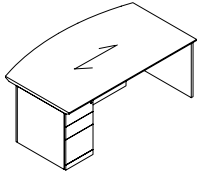

Single Pedestal Bow Top Desk - LEFT
Breakfront Style

DMISL8442D	42 x 84 x 29	125	432	59	\$3902	\$4683
DMISL7842D	42 x 78 x 29	125	401	55	\$3624	\$4349
DMISL7242D	42 x 72 x 29	125	370	51	\$3346	\$4016
DMISL6636D	36 x 66 x 29	150	230	40	\$3218	\$3862

Standard with full to floor **box/box/file** pedestal on **left**. Bow top. Pedestal locks. Refer to the Desks and Credenzas Notes Section on page 10 for overhang dimensions.

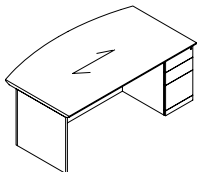

Single Pedestal Bow Top Desk - RIGHT
Breakfront Style

DMISR8442D	42 x 84 x 29	125	432	59	\$3902	\$4683
DMISR7842D	42 x 78 x 29	125	401	55	\$3624	\$4349
DMISR7242D	42 x 72 x 29	125	370	51	\$3346	\$4016
DMISR6636D	36 x 66 x 29	150	230	40	\$3218	\$3862

Standard with full to floor **box/box/file** pedestal on **right**. Bow top. Pedestal locks. Refer to the Desks and Credenzas Notes Section on page 10 for overhang dimensions.

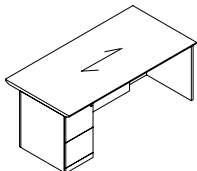

Single Pedestal Desk - LEFT
Breakfront Style

DISL8442E	42 x 84 x 29	125	463	59	\$3723	\$4468
DISL7842E	42 x 78 x 29	125	430	55	\$3458	\$4150
DISL7236E	36 x 72 x 29	125	340	44	\$2736	\$3284
DISL7230E	30 x 72 x 29	125	283	36	\$2615	\$3138
DISL6636E	36 x 66 x 29	125	312	40	\$2615	\$3138
DISL6630E	30 x 66 x 29	100	295	33	\$2496	\$2996
DISL6030E	30 x 60 x 29	100	265	30	\$2386	\$2864

Standard with full to floor **file/file** pedestal on **left**. Pedestal locks. Refer to the Desks and Credenzas Notes Section on page 10 for overhang dimensions.

Required Specifications

Veneer Finish
Laminate Finish
Handle Style

Optional Specifications

Grommet

D DUFFERIN

SINGLE PEDESTAL DESKS - BREAKFRONT STYLE

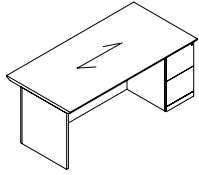

**Single Pedestal Desk - RIGHT
Breakfront Style**

MODEL#	DIMENSIONS D x W x H	FREIGHT CLASS	WT/LBS.	CUBIC FT.	VENEER/LAMINATE	ALL VENEER
DISR8442E	42 x 84 x 29	125	463	59	\$3723	\$4468
DISR7842E	42 x 78 x 29	125	430	55	\$3458	\$4150
DISR7236E	36 x 72 x 29	125	340	44	\$2736	\$3284
DISR7230E	30 x 72 x 29	125	283	36	\$2615	\$3138
DISR6636E	36 x 66 x 29	125	312	40	\$2615	\$3138
DISR6630E	30 x 66 x 29	100	295	33	\$2496	\$2996
DISR6030E	30 x 60 x 29	100	265	30	\$2386	\$2864

Standard with full to floor **file/file** pedestal on **right**. Pedestal locks. Refer to the Desks and Credenzas Notes Section on page 10 for overhang dimensions.

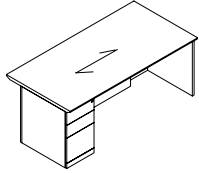

**Single Pedestal Desk - LEFT
Breakfront Style**

DISL8442D	42 x 84 x 29	125	463	59	\$3723	\$4468
DISL7842D	42 x 78 x 29	125	430	55	\$3458	\$4150
DISL7236D	36 x 72 x 29	125	340	44	\$2736	\$3284
DISL7230D	30 x 72 x 29	125	283	36	\$2615	\$3138
DISL6636D	36 x 66 x 29	125	312	40	\$2615	\$3138
DISL6630D	30 x 66 x 29	100	295	33	\$2496	\$2996
DISL6030D	30 x 60 x 29	100	265	30	\$2386	\$2864

Standard with full to floor **box/box/file** pedestal on **left**. Pedestal locks. Refer to the Desks and Credenzas Notes Section on page 10 for overhang dimensions.

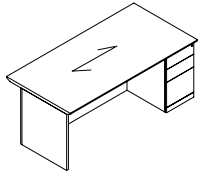

**Single Pedestal Desk - RIGHT
Breakfront Style**

DISR8442D	42 x 84 x 29	125	463	59	\$3723	\$4468
DISR7842D	42 x 78 x 29	125	430	55	\$3458	\$4150
DISR7236D	36 x 72 x 29	125	340	44	\$2736	\$3284
DISR7230D	30 x 72 x 29	125	283	36	\$2615	\$3138
DISR6636D	36 x 66 x 29	125	312	40	\$2615	\$3138
DISR6630D	30 x 66 x 29	100	295	33	\$2496	\$2996
DISR6030D	30 x 60 x 29	100	265	30	\$2386	\$2864

Standard with full to floor **box/box/file** pedestal on **right**. Pedestal locks. Refer to the Desks and Credenzas Notes Section on page 10 for overhang dimensions.

DESK SHELLS WITH RECESSED FRONT

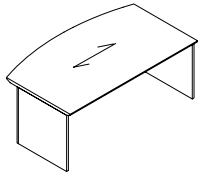

Bow Top Desk Shell

DMT8442	42 x 84 x 29	125	380	59	\$3000	\$3600
DMT7842	42 x 78 x 29	125	353	55	\$2784	\$3341
DMT7242	42 x 72 x 29	125	331	51	\$2572	\$3087
DMT6636	36 x 66 x 29	125	287	40	\$2452	\$2943

Bow top and recessed modesty panel. Refer to the Desks and Credenzas Notes Section on page 10 for overhang dimensions.

Required Specifications

Veneer Finish
Laminate Finish
Handle Style (Single Pedestal Desks)

Optional Specifications

Grommet

DESK SHELLS	MODEL#	DIMENSIONS	FREIGHT CLASS	WT/LBS.	CUBIC FT.	VENEER/LAMINATE	ALL VENEER
		D x W x H					
	DT8436	36 x 84 x 29	125	362	51	\$2391	\$2870
	DT7836	36 x 78 x 29	125	336	47	\$2221	\$2666
	DT7236	36 x 72 x 29	125	315	44	\$2049	\$2459
	DT6636	36 x 66 x 29	125	271	40	\$1931	\$2318
	DT7230	30 x 72 x 29	125	271	36	\$1931	\$2318
	DT6630	30 x 66 x 29	100	265	33	\$1813	\$2176
	DT6030	30 x 60 x 29	100	241	30	\$1658	\$1990
	DT4824	24 x 48 x 29	125	123	20	\$1091	\$1310
	DT4224	24 x 42 x 29	150	98	17	\$914	\$1097
	DT3624	24 x 36 x 29	150	82	14	\$880	\$1056
	DT3024	24 x 30 x 29	125	76	12	\$863	\$1036
	DT4822	22 x 48 x 29	150	105	18	\$1000	\$1200
	DT4222	22 x 42 x 29	150	90	16	\$837	\$1005
	DT3622	22 x 36 x 29	150	75	13	\$808	\$970
	DT3022	22 x 30 x 29	150	65	11	\$791	\$950
	DT4820	20 x 48 x 29	125	105	18	\$910	\$1092
	DT4220	20 x 42 x 29	125	90	16	\$760	\$912
	DT3620	20 x 36 x 29	125	75	13	\$735	\$882
	DT3020	20 x 30 x 29	125	65	11	\$719	\$863

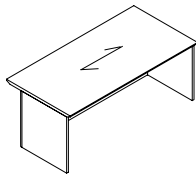

Desk Shell

Recessed modesty panel. Refer to the Desks and Credenzas Notes Section on page 10 for overhang dimensions.

RETURNS

- An Executive Return is used to attach to a Single Pedestal Desk, Single Pedestal Credenza, Desk Shell or Credenza Shell.
- Grommets are available as an option.
- Hand of Executive Return is determined by location of full end panel from user side.
- Hand of Desk or Credenza is determined by location of pedestal from user side.
- To remove cross grain veneer pattern on top, delete suffix "CG" from the model number. Available as a special - no upcharge.

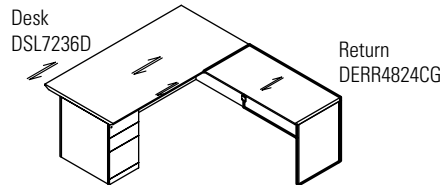
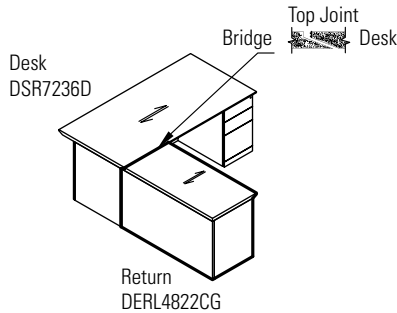

RETURNS

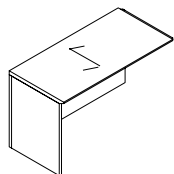

Flush Return - LEFT 24" Deep

DERL7224CG	24 x 72 x 29	150	135	29	\$1278	\$1534
DERL6624CG	24 x 66 x 29	150	127	27	\$1445	\$1734
DERL6024CG	24 x 60 x 29	150	120	24	\$1315	\$1578
DERL5424CG	24 x 54 x 29	150	112	22	\$1186	\$1424
DERL4824CG	24 x 48 x 29	150	105	19	\$1051	\$1262
DERL4224CG	24 x 42 x 29	150	97	17	\$922	\$1107

Return has **no pedestal**. For use with right handed single pedestal desks, credenzas, desk shells, credenza shells, "D" islands or "P" islands.

Required Specifications

Veneer Finish
Laminate Finish

Optional Specifications

Grommet

RETURNS

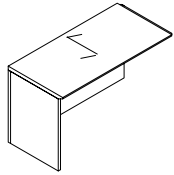

Flush Return - LEFT
22" Deep

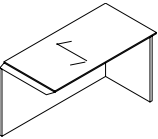

Flush Return - RIGHT
24" Deep

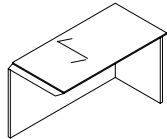

Flush Return - RIGHT
22" Deep

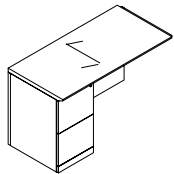

Flush Return - LEFT
24" Deep

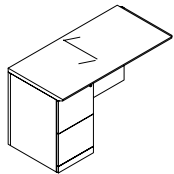

Flush Return - LEFT
22" Deep

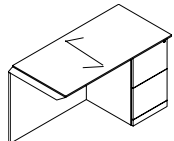

Flush Return - RIGHT
24" Deep

MODEL#	DIMENSIONS	FREIGHT CLASS	WT/LBS.	CUBIC FT.	veneer/LAMINATE	ALL veneer
--------	------------	---------------	---------	-----------	-----------------	------------

D x W x H

DERL7222CG	22 x 72 x 29	150	130	27	\$1380	\$1656
DERL6622CG	22 x 66 x 29	150	122	24	\$1260	\$1512
DERL6022CG	22 x 60 x 29	150	115	22	\$1149	\$1379
DERL5422CG	22 x 54 x 29	150	105	20	\$1102	\$1323
DERL4822CG	22 x 48 x 29	150	100	18	\$922	\$1107
DERL4222CG	22 x 42 x 29	150	90	16	\$806	\$968

Return has **no pedestal**. For use with right handed single pedestal desks, credenzas, desk shells, credenza shells, "D" islands or "P" islands.

DERR7224CG	24 x 72 x 29	150	135	29	\$1579	\$1895
DERR6624CG	24 x 66 x 29	150	127	27	\$1445	\$1734
DERR6024CG	24 x 60 x 29	150	120	24	\$1315	\$1578
DERR5424CG	24 x 54 x 29	150	112	22	\$1186	\$1424
DERR4824CG	24 x 48 x 29	150	105	19	\$1051	\$1262
DERR4224CG	24 x 42 x 29	150	97	17	\$922	\$1107

Return has **no pedestal**. For use with left handed single pedestal desks, credenzas, desk shells, credenza shells, "D" islands or "P" islands.

DERR7222CG	22 x 72 x 29	150	130	27	\$1505	\$1806
DERR6622CG	22 x 66 x 29	150	122	24	\$1260	\$1512
DERR6022CG	22 x 60 x 29	150	115	22	\$1149	\$1379
DERR5422CG	22 x 54 x 29	150	105	20	\$1033	\$1240
DERR4822CG	22 x 48 x 29	150	100	18	\$917	\$1101
DERR4222CG	22 x 42 x 29	150	90	16	\$801	\$962

Return has **no pedestal**. For use with left handed single pedestal desks, credenzas, desk shells, credenza shells, "D" islands or "P" islands.

DERL7224ECG	24 x 72 x 29	100	250	29	\$2788	\$3346
DERL6624ECG	24 x 66 x 29	100	236	27	\$2681	\$3218
DERL6024ECG	24 x 60 x 29	100	227	24	\$2440	\$2928
DERL5424ECG	24 x 54 x 29	100	205	22	\$2352	\$2823
DERL4824ECG	24 x 48 x 29	100	185	19	\$2088	\$2506
DERL4224ECG	24 x 42 x 29	92.5	178	17	\$2014	\$2417

Return has **file/file** pedestal on the **left**. Pedestal locks. For use with right handed single pedestal desks, credenzas, desk shells, credenza shells, "D" islands or "P" islands.

DERL7222ECG	22 x 72 x 29	100	240	27	\$2681	\$3218
DERL6622ECG	22 x 66 x 29	100	231	24	\$2366	\$2840
DERL6022ECG	22 x 60 x 29	92.5	222	22	\$2153	\$2584
DERL5422ECG	22 x 54 x 29	92.5	200	20	\$2075	\$2490
DERL4822ECG	22 x 48 x 29	92.5	180	18	\$1844	\$2213
DERL4222ECG	22 x 42 x 29	92.5	173	16	\$1774	\$2129

Return has **file/file** pedestal on the **left**. Pedestal locks. For use with right handed single pedestal desks, credenzas, desk shells, credenza shells, "D" islands or "P" islands.

DERR7224ECG	24 x 72 x 29	100	250	29	\$2788	\$3346
DERR6624ECG	24 x 66 x 29	100	236	27	\$2681	\$3218
DERR6024ECG	24 x 60 x 29	100	227	24	\$2440	\$2928
DERR5424ECG	24 x 54 x 29	100	205	22	\$2352	\$2823
DERR4824ECG	24 x 48 x 29	100	185	19	\$2088	\$2506
DERR4224ECG	24 x 42 x 29	92.5	178	17	\$2014	\$2417

Return has **file/file** pedestal on the **right**. Pedestal locks. For use with right handed single pedestal desks, credenzas, desk shells, credenza shells, "D" islands or "P" islands.

Required Specifications

Veneer Finish
Laminate Finish
Handle Style (Returns w/Pedestals)

Optional Specifications

Grommet

RETURNS

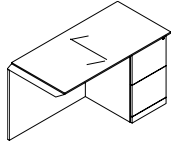

Flush Return - RIGHT
22" Deep

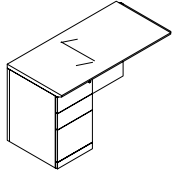

Flush Return - LEFT
24" Deep

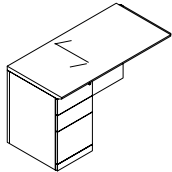

Flush Return - LEFT
22" Deep

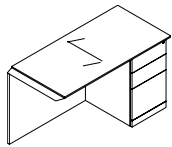

Flush Return - RIGHT
24" Deep

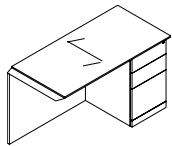

Flush Return - RIGHT
22" Deep

MODEL#	DIMENSIONS	FREIGHT CLASS	WT/LBS.	CUBIC FT.	veneer/LAMINATE	ALL VENEER
--------	------------	---------------	---------	-----------	-----------------	------------

D x W x H

DERR7222ECG	22 x 72 x 29	100	240	27	\$2681	\$3218
DERR6622ECG	22 x 66 x 29	100	231	24	\$2366	\$2840
DERR6022ECG	22 x 60 x 29	92.5	222	22	\$2153	\$2584
DERR5422ECG	22 x 54 x 29	92.5	200	20	\$2075	\$2490
DERR4822ECG	22 x 48 x 29	92.5	180	18	\$1844	\$2213
DERR4222ECG	22 x 42 x 29	92.5	173	16	\$1774	\$2129

Return has **file/file** pedestal on the **right**. Pedestal locks. For use with right handed single pedestal desks, credenzas, desk shells, credenza shells, "D" islands or "P" islands.

DERL7224DCG	24 x 72 x 29	100	250	29	\$2788	\$3346
DERL6624DCG	24 x 66 x 29	100	236	27	\$2681	\$3218
DERL6024DCG	24 x 60 x 29	100	227	24	\$2440	\$2928
DERL5424DCG	24 x 54 x 29	100	205	22	\$2352	\$2823
DERL4824DCG	24 x 48 x 29	100	185	19	\$2088	\$2506
DERL4224DCG	24 x 42 x 29	92.5	178	17	\$2014	\$2417

Return has **box/box/file** pedestal on the **left**. Pedestal locks. For use with right handed single pedestal desks, credenzas, desk shells, credenza shells, "D" islands or "P" islands.

DERL7222DCG	22 x 72 x 29	100	240	27	\$2681	\$3218
DERL6622DCG	22 x 66 x 29	100	231	24	\$2366	\$2840
DERL6022DCG	22 x 60 x 29	92.5	222	22	\$2153	\$2584
DERL5422DCG	22 x 54 x 29	92.5	200	20	\$2075	\$2490
DERL4822DCG	22 x 48 x 29	150	180	18	\$1844	\$2213
DERL4222DCG	22 x 42 x 29	92.5	173	16	\$1774	\$2129

Return has **box/box/file** pedestal on the **left**. Pedestal locks. For use with right handed single pedestal desks, credenzas, desk shells, credenza shells, "D" islands or "P" islands.

DERR7224DCG	24 x 72 x 29	100	250	29	\$2788	\$3346
DERR6624DCG	24 x 66 x 29	100	236	27	\$2681	\$3218
DERR6024DCG	24 x 60 x 29	100	227	24	\$2440	\$2928
DERR5424DCG	24 x 54 x 29	100	205	22	\$2352	\$2823
DERR4824DCG	24 x 48 x 29	100	185	19	\$2088	\$2506
DERR4224DCG	24 x 42 x 29	92.5	178	17	\$2014	\$2417

Return has **box/box/file** pedestal on the **right**. Pedestal locks. For use with right handed single pedestal desks, credenzas, desk shells, credenza shells, "D" islands or "P" islands.

DERR7222DCG	22 x 72 x 29	100	240	27	\$2681	\$3218
DERR6622DCG	22 x 66 x 29	100	231	24	\$2366	\$2840
DERR6022DCG	22 x 60 x 29	92.5	222	22	\$2153	\$2584
DERR5422DCG	22 x 54 x 29	92.5	200	20	\$2075	\$2490
DERR4822DCG	22 x 48 x 29	92.5	180	18	\$1844	\$2213
DERR4222DCG	22 x 42 x 29	92.5	173	16	\$1774	\$2129

Return has **box/box/file** pedestal on the **right**. Pedestal locks. For use with right handed single pedestal desks, credenzas, desk shells, credenza shells, "D" islands or "P" islands.

Required Specifications

Veneer Finish
Laminate Finish
Handle Style

Optional Specifications

Grommet

D DUFFERIN

BRIDGES - EXECUTIVE

MODEL#

DIMENSIONS

FREIGHT CLASS

WT/LBS.

CUBIC FT.

VENEER/LAMINATE

ALL VENEER

D x W x H

- An Executive Bridge is used to connect a Desk to a Credenza.
- Not to be used with Corner Components or Piano Desks,
- Three Modesty Panel options - Full Modesty, 8" Modesty and No Modesty (Flush Bridge Top).
- Modesty panel flush with end panels of Desk and Credenza.
- Includes GM1 grommet in the top center position.
- Both connecting sides of executive bridges feature a reverse profile edge

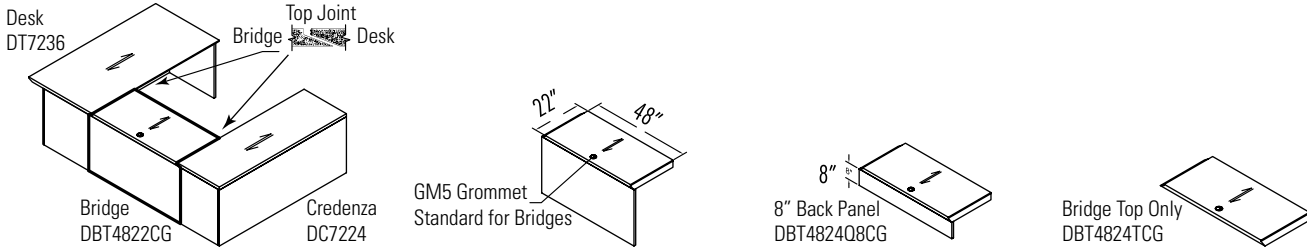

BRIDGES - LINKING

- A Linking Bridge is used to connect Corner Components to a Single Pedestal Desk, Single Pedestal Credenza, Desk Shell or Credenza Shell.
- Two Modesty Panel options - Full Modesty and 8" Modesty.
- Includes GM1 grommet in the top center position.
- Hand of Linking Bridge is determined by location of half end panel from user side.
- Linking Bridges are handed **left and right** (Handedness is determined by connecting side with the self edge). The opposite connecting side features a reverse profile edge.

Supporting Slab Joining Structure

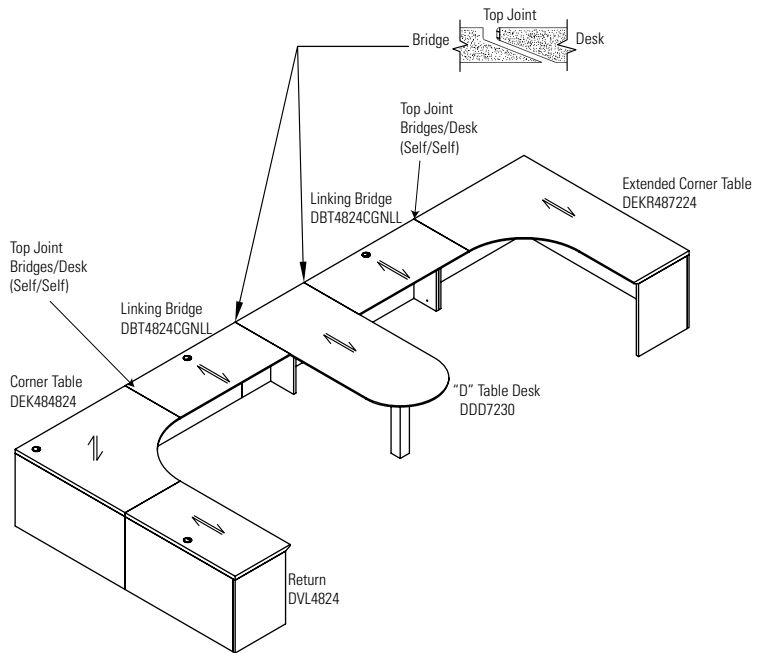
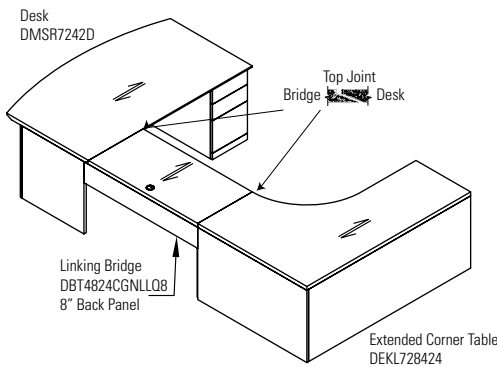
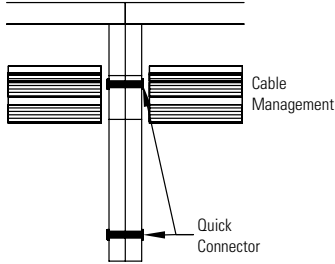

BRIDGES - EXECUTIVE

MODEL#	DIMENSIONS	FREIGHT CLASS	WT/LBS.	CUBIC FT.	VENEER/LAMINATE	ALL VENEER
--------	------------	---------------	---------	-----------	-----------------	------------

D x W x H

DBT6024CG	24 x 60 x 29	70	144	10	\$1129	\$1355
DBT5424CG	24 x 54 x 29	70	129	9	\$1018	\$1222
DBT4824CG	24 x 48 x 29	70	120	8	\$903	\$1084
DBT4224CG	24 x 42 x 29	85	105	7	\$790	\$948
DBT6022CG	22 x 60 x 29	70	138	9	\$924	\$1109
DBT5422CG	22 x 54 x 29	70	124	8	\$915	\$1098
DBT4822CG	22 x 48 x 29	85	115	7	\$812	\$975
DBT4222CG	22 x 42 x 29	85	101	6	\$712	\$855
DBT6020CG	20 x 60 x 29	70	131	8	\$924	\$1109
DBT5420CG	20 x 54 x 29	85	118	8	\$833	\$1000
DBT4820CG	20 x 48 x 29	85	110	7	\$740	\$888
DBT4220CG	20 x 42 x 29	85	96	6	\$634	\$761

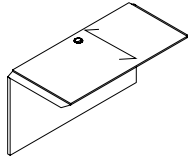

Flush Bridge

Top surface, back panel and hardware to create a "U" configuration with a single pedestal desk or credenza. **Cannot be used with corners.** Grommet in worksurface. Shipped RTA (ready to assemble).

- If linking to bookcase or open storage, add **/S** to end of model number

DBT5424TCG	24 x 54 x --	70	129	9	N/A	\$762
DBT4824TCG	24 x 48 x --	70	120	8	N/A	\$677
DBT4224TCG	24 x 42 x --	70	105	7	N/A	\$593
DBT5422TCG	22 x 54 x --	70	124	8	N/A	\$612
DBT4822TCG	22 x 48 x --	70	115	7	N/A	\$544
DBT4222TCG	22 x 42 x --	70	101	6	N/A	\$476
DBT5420TCG	20 x 54 x --	70	118	8	N/A	\$559
DBT4820TCG	20 x 48 x --	70	110	7	N/A	\$496
DBT4220TCG	20 x 42 x --	70	96	6	N/A	\$425

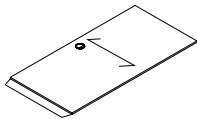

Flush Bridge Top

Top surface only to create a "U" configuration with a single pedestal desk or credenza. **Cannot be used with corners.** Grommet in worksurface. Shipped RTA (ready to assemble).

- If linking to bookcase or open storage, add **/S** to end of model number

DBT6024Q8CG	24 x 60 x --	70	144	10	\$1015	\$1218
DBT5424Q8CG	24 x 54 x --	70	129	9	\$915	\$1098
DBT4824Q8CG	24 x 48 x --	70	120	8	\$813	\$976
DBT4224Q8CG	24 x 42 x --	70	105	7	\$711	\$854
DBT6022Q8CG	22 x 60 x --	70	138	9	\$915	\$1098
DBT5422Q8CG	22 x 54 x --	70	124	8	\$823	\$988
DBT4822Q8CG	22 x 48 x --	70	115	7	\$730	\$876
DBT4222Q8CG	22 x 42 x --	70	101	6	\$641	\$770
DBT6020Q8CG	20 x 60 x --	70	131	8	\$833	\$1000
DBT5420Q8CG	20 x 54 x --	70	118	8	\$749	\$899
DBT4820Q8CG	20 x 48 x --	70	110	7	\$666	\$800
DBT4220Q8CG	20 x 42 x --	70	96	6	\$570	\$684

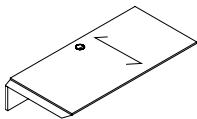

Flush Bridge Top, 8" Modesty Panel

Top surface with 8" modesty panel for utility access. Create a "U" configuration with a single pedestal desk or credenza. **Cannot be used with corners.** Grommet in worksurface. Shipped RTA (ready to assemble).

- If linking to bookcase or open storage, add **/S** to end of model number

Required Specifications

Veneer Finish
Laminate Finish
Handle Style

Optional Specifications

Additional Grommet

BRIDGES - LINKING

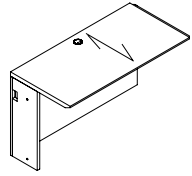

Linking Bridge - LEFT

MODEL#	DIMENSIONS D x W x H	FREIGHT CLASS	WT/LBS.	CUBIC FT.	VENEER/LAMINATE	ALL VENEER
DBT6024NLLCG	24 x 60 x 29	125	145	24	\$1119	\$1343
DBT5424NLLCG	24 x 54 x 29	150	131	22	\$1008	\$1210
DBT4824NLLCG	24 x 48 x 29	125	116	19	\$896	\$1076
DBT4224NLLCG	24 x 42 x 29	125	102	17	\$725	\$870
DBT3624NLLCG	24 x 36 x 29	150	87	15	\$660	\$792
DBT3024NLLCG	24 x 30 x 29	125	73	12	\$643	\$772
DBT6022NLLCG	22 x 60 x 29	150	131	22	\$1066	\$1280
DBT5422NLLCG	22 x 54 x 29	150	118	20	\$961	\$1154
DBT4822NLLCG	22 x 48 x 29	125	110	18	\$852	\$1023
DBT4222NLLCG	22 x 42 x 29	150	95	16	\$692	\$831
DBT3622NLLCG	22 x 36 x 29	125	80	13	\$627	\$753
DBT3022NLLCG	22 x 30 x 29	150	65	11	\$613	\$736

Top surface, back panel and hardware. **Left side** connects to a 5-Sided Corner, Extended Corner or Connectable Table. Right side connects to a single pedestal desk or credenza, "D" island, Boat shaped island, "P" island and Delta island with a "T" base. Grommet in worksurface.

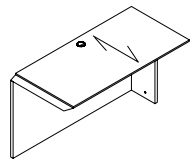

Linking Bridge - RIGHT

DBT6024NLR CG	24 x 60 x 29	125	145	24	\$1119	\$1343
DBT5424NLR CG	24 x 54 x 29	150	131	22	\$1008	\$1210
DBT4824NLR CG	24 x 48 x 29	125	116	19	\$896	\$1076
DBT4224NLR CG	24 x 42 x 29	125	102	17	\$725	\$870
DBT3624NLR CG	24 x 36 x 29	150	87	15	\$660	\$792
DBT3024NLR CG	24 x 30 x 29	125	73	12	\$643	\$772
DBT6022NLR CG	22 x 60 x 29	150	131	22	\$1066	\$1280
DBT5422NLR CG	22 x 54 x 29	150	118	20	\$961	\$1154
DBT4822NLR CG	22 x 48 x 29	125	110	18	\$852	\$1023
DBT4222NLR CG	22 x 42 x 29	150	95	16	\$692	\$831
DBT3622NLR CG	22 x 36 x 29	125	80	13	\$627	\$753
DBT3022NLR CG	22 x 30 x 29	150	65	11	\$613	\$736

Top surface, back panel and hardware. **Right side** connects to a 5-Sided Corner, Extended Corner or Connectable Table. Left side connects to a single pedestal desk or credenza, "D" island, Boat shaped island, "P" island and Delta island with a "T" base. Grommet in worksurface.

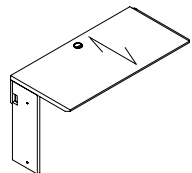

Linking Bridge, 8" Modesty Panel - LEFT

DBT6024NLLQ8CG	24 x 60 x 29	125	145	24	\$1232	\$1479
DBT5424NLLQ8CG	24 x 54 x 29	150	131	22	\$1111	\$1334
DBT4824NLLQ8CG	24 x 48 x 29	125	116	19	\$987	\$1185
DBT4224NLLQ8CG	24 x 42 x 29	125	102	17	\$887	\$1065
DBT3624NLLQ8CG	24 x 36 x 29	150	87	15	\$725	\$870
DBT3024NLLQ8CG	24 x 30 x 29	125	73	12	\$710	\$852
DBT6022NLLQ8CG	22 x 60 x 29	150	131	22	\$1174	\$1409
DBT5422NLLQ8CG	22 x 54 x 29	150	118	20	\$1057	\$1269
DBT4822NLLQ8CG	22 x 48 x 29	125	110	18	\$939	\$1127
DBT4222NLLQ8CG	22 x 42 x 29	150	95	16	\$759	\$911
DBT3622NLLQ8CG	22 x 36 x 29	125	80	13	\$691	\$830
DBT3022NLLQ8CG	22 x 30 x 29	150	65	11	\$675	\$810

Top surface with 8" modesty panel for utility access and hardware. **Left side** connects to a 5-Sided Corner, Extended Corner or Connectable Table. Right side connects to a single pedestal desk or credenza, "D" island, Boat shaped island, "P" island and Delta island with a "T" base. Grommet in worksurface. Shipped RTA (ready to assemble).

Required Specifications

Veneer Finish
Laminate Finish

Optional Specifications

Additional Grommet

BRIDGES - LINKING

MODEL# DIMENSIONS FREIGHT CLASS WT/LBS. CUBIC FT. VENEER/LAMINATE ALL VENEER

D x W x H

DBT6024NLRQ8CG	24 x 60 x 29	125	145	24	\$1232	\$1479
DBT5424NLRQ8CG	24 x 54 x 29	150	131	22	\$1111	\$1334
DBT4824NLRQ8CG	24 x 48 x 29	125	116	19	\$987	\$1185
DBT4224NLRQ8CG	24 x 42 x 29	125	102	17	\$887	\$1065
DBT3624NLRQ8CG	24 x 36 x 29	150	87	15	\$725	\$870
DBT3024NLRQ8CG	24 x 30 x 29	125	73	12	\$710	\$852
DBT6022NLRQ8CG	22 x 60 x 29	150	131	22	\$1174	\$1409
DBT5422NLRQ8CG	22 x 54 x 29	150	118	20	\$1057	\$1269
DBT4822NLRQ8CG	22 x 48 x 29	125	110	18	\$939	\$1127
DBT4222NLRQ8CG	22 x 42 x 29	150	95	16	\$759	\$911
DBT3622NLRQ8CG	22 x 36 x 29	125	80	13	\$691	\$830
DBT3022NLRQ8CG	22 x 30 x 29	150	65	11	\$675	\$810

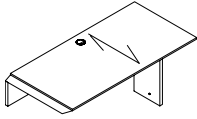

Linking Bridge, 8" Modesty Panel - RIGHT

Top surface with 8" modesty panel for utility access and hardware. **Right side** connects to a 5-Sided Corner, Extended Corner or Connectable Table. Right side connects to a single pedestal desk or credenza, "D" island, Boat shaped island, "P" island and Delta island with a "T" base. Grommet in worksurface. Shipped RTA (ready to assemble).

CREDENZAS

DC12024	24 x 120 x 29	100	387	48	\$2820	\$3384
DC11424	24 x 114 x 29	125	367	46	\$2679	\$3215
DC10824	24 x 108 x 29	125	348	44	\$2538	\$3046
DC10224	24 x 102 x 29	100	329	41	\$2397	\$2877
DC9624	24 x 96 x 29	125	309	39	\$2255	\$2706
DC9024	24 x 90 x 29	100	290	36	\$2115	\$2538
DC8424	24 x 84 x 29	125	271	34	\$1974	\$2369
DC7824	24 x 78 x 29	100	251	31	\$1832	\$2199
DC7224	24 x 72 x 29	100	232	29	\$1692	\$2031
DC6624	24 x 66 x 29	125	213	27	\$1629	\$1955
DC6024	24 x 60 x 29	100	193	24	\$1480	\$1776
DC5424	24 x 54 x 29	125	174	22	\$1403	\$1684
DC4824	24 x 48 x 29	100	155	19	\$1325	\$1590
DC4224	24 x 42 x 29	125	135	17	\$1122	\$1347
DC12022	22 x 120 x 29	100	358	44	\$2584	\$3101
DC11422	22 x 114 x 29	100	340	42	\$2455	\$2946
DC10822	22 x 108 x 29	100	323	40	\$2326	\$2792
DC10222	22 x 102 x 29	100	305	38	\$2196	\$2636
DC9622	22 x 96 x 29	100	287	35	\$2069	\$2483
DC9022	22 x 90 x 29	100	269	33	\$1939	\$2327
DC8422	22 x 84 x 29	100	251	31	\$1811	\$2174
DC7822	22 x 78 x 29	100	233	29	\$1680	\$2016
DC7222	22 x 72 x 29	125	215	27	\$1551	\$1862
DC6622	22 x 66 x 29	100	197	24	\$1496	\$1796
DC6022	22 x 60 x 29	100	179	22	\$1357	\$1629
DC5422	22 x 54 x 29	100	161	20	\$1286	\$1544
DC4822	22 x 48 x 29	125	143	18	\$1217	\$1461
DC4222	22 x 42 x 29	125	125	16	\$1028	\$1234

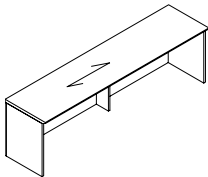

sizes 96" and larger

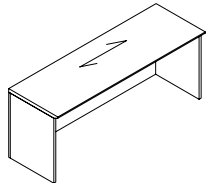

sizes less than 96"

Credenza Shell

Standard with **no pedestals**. Flush full modesty panel. 96" w and larger includes a center support leg. If using storage component shells underneath to support the worksurface, **no more than 72" may be left unsupported**.

Required Specifications

Veneer Finish
Laminate Finish

Optional Specifications

Grommet

Accessories

Modular Storage (Credenza Shell)

CREDENZAS

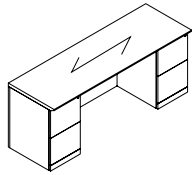

Kneespace Credenza

MODEL#	DIMENSIONS D x W x H	FREIGHT CLASS	WT/LBS.	CUBIC FT.	VENEER/LAMINATE	ALL VENEER
DCK8424EE	24 x 84 x 29	92.5	348	34	\$4180	\$5016
DCK7824EE	24 x 78 x 29	92.5	319	31	\$3883	\$4660
DCK7224EE	24 x 72 x 29	100	280	29	\$3585	\$4302
DCK6624EE	24 x 66 x 29	100	261	27	\$3531	\$4238
DCK6024EE	24 x 60 x 29	100	238	24	\$3284	\$3941
DCK8422EE	22 x 84 x 29	92.5	320	34	\$3831	\$4598
DCK7822EE	22 x 78 x 29	92.5	298	31	\$3559	\$4271
DCK7222EE	22 x 72 x 29	92.5	280	29	\$3285	\$3942
DCK6622EE	22 x 66 x 29	92.5	257	27	\$3236	\$3884
DCK6022EE	22 x 60 x 29	92.5	233	24	\$3010	\$3612

Standard with full to floor **file/file** pedestals on **left and right**. **Center is open** Pedestals lock.

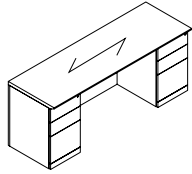

Kneespace Credenza

DCK8424DD	24 x 84 x 29	92.5	348	34	\$4180	\$5016
DCK7824DD	24 x 78 x 29	92.5	319	31	\$3883	\$4660
DCK7224DD	24 x 72 x 29	100	280	29	\$3585	\$4302
DCK6624DD	24 x 66 x 29	100	261	27	\$3531	\$4238
DCK6024DD	24 x 60 x 29	100	238	24	\$3284	\$3941
DCK8422DD	22 x 84 x 29	92.5	320	34	\$3831	\$4598
DCK7822DD	22 x 78 x 29	92.5	298	31	\$3559	\$4271
DCK7222DD	22 x 72 x 29	92.5	280	29	\$3285	\$3942
DCK6622DD	22 x 66 x 29	92.5	257	27	\$3236	\$3884
DCK6022DD	22 x 60 x 29	92.5	233	24	\$3010	\$3612

Standard with full to floor **box/box/file** pedestals on **left and right**. **Center is open** Pedestals lock. One pencil tray.

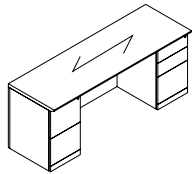

Kneespace Credenza

DCK8424ED	24 x 84 x 29	92.5	348	34	\$4180	\$5016
DCK7824ED	24 x 78 x 29	92.5	319	31	\$3883	\$4660
DCK7224ED	24 x 72 x 29	100	280	29	\$3585	\$4302
DCK6624ED	24 x 66 x 29	100	261	27	\$3531	\$4238
DCK6024ED	24 x 60 x 29	100	238	24	\$3284	\$3941
DCK8422ED	22 x 84 x 29	92.5	320	34	\$3831	\$4598
DCK7822ED	22 x 78 x 29	92.5	298	31	\$3559	\$4271
DCK7222ED	22 x 72 x 29	92.5	280	29	\$3285	\$3942
DCK6622ED	22 x 66 x 29	92.5	257	27	\$3236	\$3884
DCK6022ED	22 x 60 x 29	92.5	233	24	\$3010	\$3612

Standard with full to floor **file/file** pedestal on **left** and **box/box/file** pedestal on **right**. **Center is open** Pedestals lock. One pencil tray.

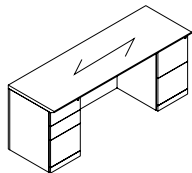

Kneespace Credenza

DCK8424DE	24 x 84 x 29	92.5	348	34	\$4180	\$5016
DCK7824DE	24 x 78 x 29	92.5	319	31	\$3883	\$4660
DCK7224DE	24 x 72 x 29	100	280	29	\$3585	\$4302
DCK6624DE	24 x 66 x 29	100	261	27	\$3531	\$4238
DCK6024DE	24 x 60 x 29	100	238	24	\$3284	\$3941
DCK8422DE	22 x 84 x 29	92.5	320	34	\$3831	\$4598
DCK7822DE	22 x 78 x 29	92.5	298	31	\$3559	\$4271
DCK7222DE	22 x 72 x 29	92.5	280	29	\$3285	\$3942
DCK6622DE	22 x 66 x 29	92.5	257	27	\$3236	\$3884
DCK6022DE	22 x 60 x 29	92.5	233	24	\$3010	\$3612

Standard with full to floor **box/box/file** pedestal on **left** and **file/file** pedestal on **right**. **Center is open** Pedestals lock. One pencil tray.

Required Specifications

Veneer Finish
Laminate Finish
Handle Style

Optional Specifications

Grommet

CREDENZAS

MODEL# DIMENSIONS FREIGHT CLASS WT/LBS. CUBIC FT. VENEER/LAMINATE ALL VENEER

D x W x H

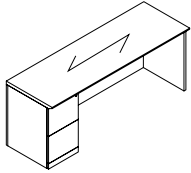

Single Pedestal Credenza - LEFT

DCL8424E	24 x 84 x 29	100	315	34	\$3161	\$3794
DCL7824E	24 x 78 x 29	100	292	31	\$2934	\$3521
DCL7224E	24 x 72 x 29	100	270	29	\$2709	\$3251
DCL6624E	24 x 66 x 29	100	247	27	\$2609	\$3131
DCL6024E	24 x 60 x 29	100	225	24	\$2371	\$2846
DCL8422E	22 x 84 x 29	100	286	34	\$2897	\$3477
DCL7822E	22 x 78 x 29	100	265	31	\$2692	\$3231
DCL7222E	22 x 72 x 29	100	250	29	\$2484	\$2981
DCL6622E	22 x 66 x 29	100	229	27	\$2392	\$2871
DCL6022E	22 x 60 x 29	100	208	24	\$2174	\$2609

Standard with full to floor **file/file** pedestal on **left**. Pedestal locks.

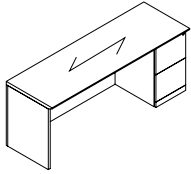

Single Pedestal Credenza - RIGHT

DCR8424E	24 x 84 x 29	100	315	34	\$3161	\$3794
DCR7824E	24 x 78 x 29	100	292	31	\$2934	\$3521
DCR7224E	24 x 72 x 29	100	270	29	\$2709	\$3251
DCR6624E	24 x 66 x 29	100	247	27	\$2609	\$3131
DCR6024E	24 x 60 x 29	100	225	24	\$2371	\$2846
DCR8422E	22 x 84 x 29	100	286	34	\$2897	\$3477
DCR7822E	22 x 78 x 29	100	265	31	\$2692	\$3231
DCR7222E	22 x 72 x 29	100	250	29	\$2484	\$2981
DCR6622E	22 x 66 x 29	100	229	27	\$2392	\$2871
DCR6022E	22 x 60 x 29	100	208	24	\$2174	\$2609

Standard with full to floor **file/file** pedestal on **right**. Pedestal locks.

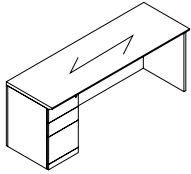

Single Pedestal Credenza - LEFT

DCL8424D	24 x 84 x 29	100	315	34	\$3161	\$3794
DCL7824D	24 x 78 x 29	100	292	31	\$2934	\$3521
DCL7224D	24 x 72 x 29	100	270	29	\$2709	\$3251
DCL6624D	24 x 66 x 29	100	247	27	\$2609	\$3131
DCL6024D	24 x 60 x 29	100	225	24	\$2371	\$2846
DCL8422D	22 x 84 x 29	100	286	34	\$2897	\$3477
DCL7822D	22 x 78 x 29	100	265	31	\$2692	\$3231
DCL7222D	22 x 72 x 29	100	250	29	\$2484	\$2981
DCL6622D	22 x 66 x 29	100	229	27	\$2392	\$2871
DCL6022D	22 x 60 x 29	100	208	24	\$2174	\$2609

Standard with full to floor **box/box/file** pedestal on **left**. Pedestal locks.

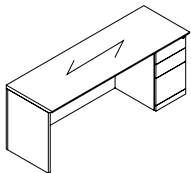

Single Pedestal Credenza - RIGHT

DCR8424D	24 x 84 x 29	100	315	34	\$3161	\$3794
DCR7824D	24 x 78 x 29	100	292	31	\$2934	\$3521
DCR7224D	24 x 72 x 29	100	270	29	\$2709	\$3251
DCR6624D	24 x 66 x 29	100	247	27	\$2609	\$3131
DCR6024D	24 x 60 x 29	100	225	24	\$2371	\$2846
DCR8422D	22 x 84 x 29	100	286	34	\$2897	\$3477
DCR7822D	22 x 78 x 29	100	265	31	\$2692	\$3231
DCR7222D	22 x 72 x 29	100	250	29	\$2484	\$2981
DCR6622D	22 x 66 x 29	100	229	27	\$2392	\$2871
DCR6022D	22 x 60 x 29	100	208	24	\$2174	\$2609

Standard with full to floor **box/box/file** pedestal on **right**. Pedestal locks.

Required Specifications

- Veneer Finish
- Laminate Finish
- Handle Style

Optional Specifications

- Grommet

CREDENZAS

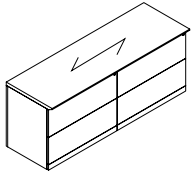

Lateral File Credenza

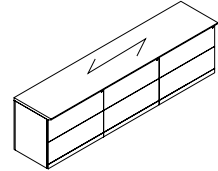

Lateral File Credenza

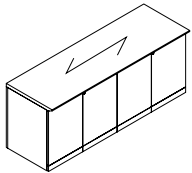

Storage Cabinet Credenza

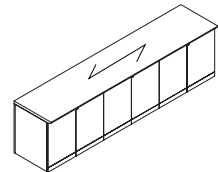

Storage Cabinet Credenza

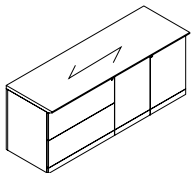

Lateral File/Storage Cabinet Credenza

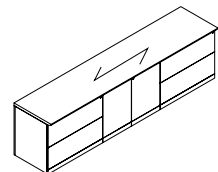

Lateral File/Storage Cabinet Credenza

MODEL#	DIMENSIONS	FREIGHT CLASS	WT/LBS.	CUBIC FT.	VENEER/LAMINATE	ALL VENEER
--------	------------	---------------	---------	-----------	-----------------	------------

D x W x H

DC7224FF	24 x 72 x 29	92.5	328	29	\$4361	\$5234
DC7222FF	22 x 72 x 29	92.5	300	27	\$3999	\$4799
DC6024NN	24 x 60 x 29	92.5	273	24	\$3998	\$4798
DC6022NN	22 x 60 x 29	100	218	22	\$3668	\$4402

Two 2-drawer lateral files side-by-side. Locking drawers. File bars included for side-to-side and front-to-back letter and legal filing capability. Anti-lock tilt suspension. **Not for stacking materials on lateral file drawer bottom.**

- "FF" models use two 36" wide lateral files, "NN" models use 30" wide.

DC10824FFF	24 x 108 x 29	92.5	457	44	\$7673	\$9208
DC10822FFF	22 x 108 x 29	92.5	435	40	\$7033	\$8440
DC9024NNN	24 x 90 x 29	92.5	381	36	\$6395	\$7674
DC9022NNN	22 x 90 x 29	92.5	372	33	\$5864	\$7037

Three 2-drawer lateral files side-by-side. Locking drawers. File bars included for side-to-side and front-to-back letter and legal filing capability. Anti-lock tilt suspension. **Not for stacking materials on lateral file drawer bottom.**

- "FFF" models use two 36" wide lateral files, "NNN" models use 30" wide.

DC7224GG	24 x 72 x 29	92.5	300	29	\$3237	\$3885
DC7222GG	22 x 72 x 29	92.5	277	27	\$2967	\$3561
DC6024MM	24 x 60 x 29	92.5	254	24	\$2967	\$3561
DC6022MM	22 x 60 x 29	92.5	232	22	\$2721	\$3266

Two 2-door storage cabinets side-by-side. Locking doors. Self-closing hinged doors cover one adjustable shelf.

- "GG" models use two 36" wide storage cabinets, "MM" models use 30" wide.

DC10824GGG	24 x 108 x 29	100	392	44	\$6117	\$7341
DC10822GGG	22 x 108 x 29	100	348	40	\$5607	\$6729
DC9024MMM	24 x 90 x 29	100	326	36	\$5098	\$6118
DC9022MMM	22 x 90 x 29	100	302	33	\$4675	\$5610

Three 2-door storage cabinets side-by-side. Locking doors. Self-closing hinged doors cover one adjustable shelf.

- "GGG" models use two 36" wide storage cabinets, "MMM" models use 30" wide.

DCF7224	24 x 72 x 29	92.5	305	29	\$3412	\$4095
DCF7222	22 x 72 x 29	92.5	285	27	\$3128	\$3754
DCF6024	24 x 60 x 29	92.5	254	24	\$2843	\$3412
DCF6022	22 x 60 x 29	92.5	233	22	\$2605	\$3126

One 2-drawer lateral file and one storage cabinet. Locking door/drawers. Storage cabinet includes one adjustable shelf. File bars included for side-by-side and front-to-back letter and legal filing capability. Anti-lock tilt suspension. **Not for stacking materials on lateral file drawer bottom.**

DC10824FGF	24 x 108 x 29	92.5	392	44	\$7156	\$8588
DC10822FGF	22 x 108 x 29	92.5	348	40	\$6558	\$7870
DC9024NMN	24 x 90 x 29	92.5	326	36	\$5963	\$7156
DC9022NMN	22 x 90 x 29	92.5	302	33	\$5467	\$6561

One 2-drawer lateral file and one storage cabinet. Locking door/drawers. Storage cabinet includes one adjustable shelf. File bars included for side-by-side and front-to-back letter and legal filing capability. Anti-lock tilt suspension. **Not for stacking materials on lateral file drawer bottom.**

- "FGF" models use two 36" wide lateral files and one 36" wide storage cabinet, "NMN" models use 30" wide.

Required Specifications

Veneer Finish
Laminate Finish
Handle Style

CREENZAS

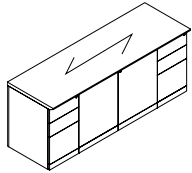

Vertical File/Storage Cabinet Credenza

MODEL#	DIMENSIONS D x W x H	FREIGHT CLASS	WT./LBS.	CUBIC FT.	VENEER/LAMINATE	ALL VENEER
DCD7224D	24 x 72 x 29	92.5	319	29	\$3999	\$4799
DCD7222D	22 x 72 x 29	92.5	298	24	\$3668	\$4402
DCD6024D	24 x 60 x 29	92.5	266	24	\$3668	\$4402
DCD6022D	22 x 60 x 29	92.5	246	20	\$3362	\$4035

Two box/box/file vertical files and one storage cabinet. Locking door/drawers. Storage cabinet includes one adjustable shelf. One pencil tray.

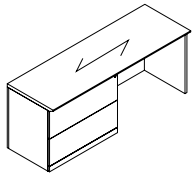

Knespace Lateral File Credenza - LEFT

DCL8424F	24 x 84 x 29	100	305	34	\$3672	\$4407
DCL7824F	24 x 78 x 29	100	285	31	\$3411	\$4094
DCL7224F	24 x 72 x 29	100	261	29	\$3147	\$3777
DCL6624F	24 x 66 x 29	100	239	27	\$3030	\$3636
DCL6024F	24 x 60 x 29	100	218	24	\$2752	\$3303

DCL8422F	22 x 84 x 29	100	266	31	\$3369	\$4043
DCL7822F	22 x 78 x 29	100	245	29	\$3126	\$3752
DCL7222F	22 x 72 x 29	100	230	27	\$2888	\$3466
DCL6622F	22 x 66 x 29	100	209	24	\$2779	\$3335
DCL6022F	22 x 60 x 29	100	188	22	\$2524	\$3029

One 2-drawer lateral file on the **left**. Locking drawers. File bars included for side-to-side and front-to-back letter and legal filing capability. Anti-lock tilt suspension. **Not for stacking materials on lateral file drawer bottom.**

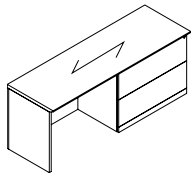

Knespace Lateral File Credenza - RIGHT

DCR8424F	24 x 84 x 29	100	305	34	\$3672	\$4407
DCR7824F	24 x 78 x 29	100	285	31	\$3411	\$4094
DCR7224F	24 x 72 x 29	100	261	29	\$3147	\$3777
DCR6624F	24 x 66 x 29	100	239	27	\$3030	\$3636
DCR6024F	24 x 60 x 29	100	218	24	\$2752	\$3303

DCR8422F	22 x 84 x 29	100	266	31	\$3369	\$4043
DCR7822F	22 x 78 x 29	100	245	29	\$3126	\$3752
DCR7222F	22 x 72 x 29	100	230	27	\$2888	\$3466
DCR6622F	22 x 66 x 29	100	209	24	\$2779	\$3335
DCR6022F	22 x 60 x 29	100	188	22	\$2524	\$3029

One 2-drawer lateral file on the **right**. Locking drawers. File bars included for side-to-side and front-to-back letter and legal filing capability. Anti-lock tilt suspension. **Not for stacking materials on lateral file drawer bottom.**

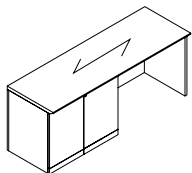

Knespace Storage Cabinet Credenza - LEFT

DCL8424G	24 x 84 x 29	100	338	34	\$3297	\$3957
DCL7824G	24 x 78 x 29	92.5	314	31	\$3063	\$3676
DCL7224G	24 x 72 x 29	92.5	290	29	\$2827	\$3393
DCL6624G	24 x 66 x 29	100	266	27	\$2720	\$3264
DCL6024G	24 x 60 x 29	92.5	242	24	\$2474	\$2969

DCL8422G	22 x 84 x 29	100	266	31	\$3026	\$3632
DCL7822G	22 x 78 x 29	100	245	29	\$2809	\$3371
DCL7222G	22 x 72 x 29	100	230	27	\$2591	\$3110
DCL6622G	22 x 66 x 29	92.5	209	24	\$2493	\$2992
DCL6022G	22 x 60 x 29	92.5	188	22	\$2269	\$2723

One storage cabinet on **left**. Locking doors. Storage cabinet has one adjustable shelf.

Required Specifications

Veneer Finish
Laminate Finish
Handle Style

Optional Specifications

Grommet (Knespace Credenzas)

CREDENZAS

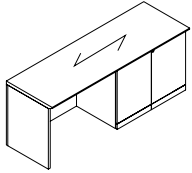

Kneespace Storage Cabinet Credenza - RIGHT

MODEL#	DIMENSIONS D x W x H	FREIGHT CLASS	WT/LBS.	CUBIC FT.	VENEER/LAMINATE	ALL VENEER
DCR8424G	24 x 84 x 29	100	338	34	\$3297	\$3957
DCR7824G	24 x 78 x 29	92.5	314	31	\$3063	\$3676
DCR7224G	24 x 72 x 29	92.5	290	29	\$2827	\$3393
DCR6624G	24 x 66 x 29	100	266	27	\$2720	\$3264
DCR6024G	24 x 60 x 29	92.5	242	24	\$2474	\$2969
DCR8422G	22 x 84 x 29	100	266	31	\$3026	\$3632
DCR7822G	22 x 78 x 29	100	245	29	\$2809	\$3371
DCR7222G	22 x 72 x 29	100	230	27	\$2591	\$3110
DCR6622G	22 x 66 x 29	92.5	209	24	\$2493	\$2992
DCR6022G	22 x 60 x 29	92.5	188	22	\$2269	\$2723

One storage cabinet on **right**. Locking doors. Storage cabinet has one adjustable shelf.

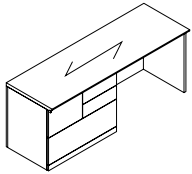

Mixed Storage Credenza - LEFT

DCL8424Z	24 x 84 x 29	100	338	34	\$4011	\$4814
DCL7824Z	24 x 78 x 29	92.5	314	31	\$3724	\$4469
DCL7224Z	24 x 72 x 29	92.5	290	29	\$3438	\$4126
DCL6624Z	24 x 66 x 29	100	266	27	\$3310	\$3972
DCL6024Z	24 x 60 x 29	92.5	242	24	\$3008	\$3610
DCL8422Z	22 x 84 x 29	92.5	309	31	\$3677	\$4413
DCL7822Z	22 x 78 x 29	100	287	29	\$3414	\$4097
DCL7222Z	22 x 72 x 29	92.5	270	27	\$3152	\$3783
DCL6622Z	22 x 66 x 29	92.5	248	24	\$3034	\$3641
DCL6022Z	22 x 60 x 29	92.5	225	22	\$2758	\$3310

Standard with two box drawers, one file drawer, and one 36"W lateral file drawer on the **left**. File drawer and lateral file drawer lock. Front-to-back and side-to-side filing. **Not for stacking materials on lateral file drawer bottom.**

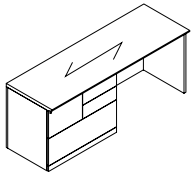

Mixed Storage Credenza - RIGHT

DCR8424Z	24 x 84 x 29	100	338	34	\$4011	\$4814
DCR7824Z	24 x 78 x 29	92.5	314	31	\$3724	\$4469
DCR7224Z	24 x 72 x 29	92.5	290	29	\$3438	\$4126
DCR6624Z	24 x 66 x 29	100	266	27	\$3310	\$3972
DCR6024Z	24 x 60 x 29	92.5	242	24	\$3008	\$3610
DCR8422Z	22 x 84 x 29	92.5	309	31	\$3677	\$4413
DCR7822Z	22 x 78 x 29	100	287	29	\$3415	\$4098
DCR7222Z	22 x 72 x 29	92.5	270	27	\$3152	\$3783
DCR6622Z	22 x 66 x 29	92.5	248	24	\$3034	\$3641
DCR6022Z	22 x 60 x 29	92.5	225	22	\$2758	\$3310

Standard with two box drawers, one file drawer, and one 36"W lateral file drawer on the **right**. File drawer and lateral file drawer lock. Front-to-back and side-to-side filing. **Not for stacking materials on lateral file drawer bottom.**

Required Specifications

Veneer Finish
Laminate Finish
Handle Style

Optional Specifications

Grommet

CORNERS MODEL# DIMENSIONS FREIGHT CLASS WT./LBS. CUBIC FT. VENEER/LAMINATE ALL VENEER

D x W x H

- A Corner Desk is used to connect to a Linking Bridge and Linking Credenza, or Connectable Table
- Cable management tray is included.
- Full Modesty Panel option.
- 5-Sided Corners include a GM1 grommet in the top center position. Grommets are available as an option on Extended Corners.
- Hand of Linking Credenza is determined by location of full end panel from user side.
- Hand of Extended Corner is determined by location of long narrow end from user side.
- Connecting sides feature a self edge.

Supporting Slab Joining Structure

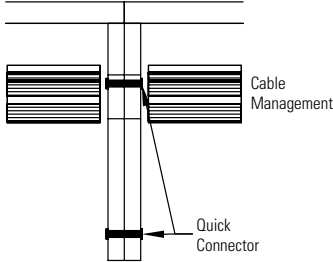

Linking Credenza (Right Hand Shown)

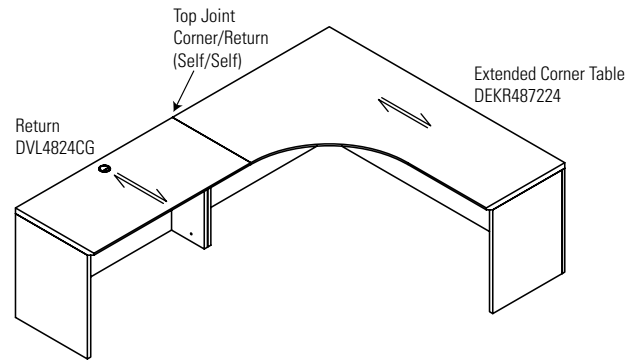
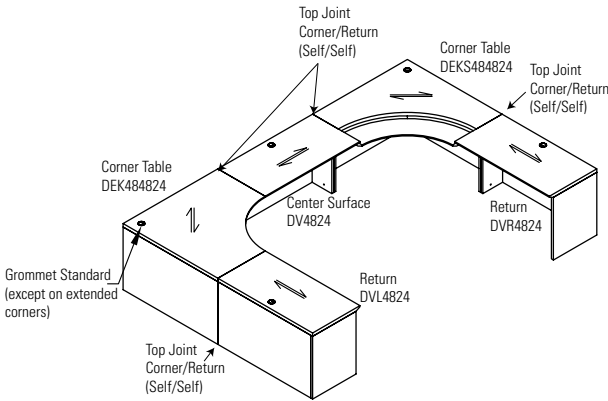
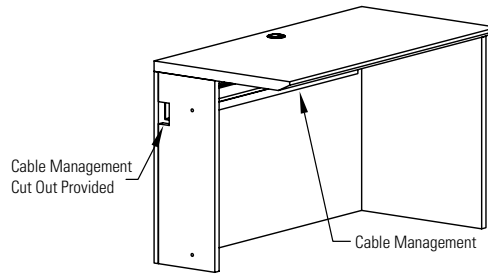

5-SIDED CORNERS

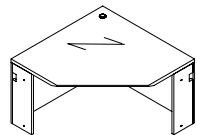

5-Sided Corner

DE484824	48 x 48 x 29	150	201	39	\$1915	\$2298
DE424224	42 x 42 x 29	150	155	30	\$1467	\$1761
DE363624	36 x 36 x 29	125	135	22	\$1395	\$1674

Connects to **24" D** connectables, returns, extended corners, storage/lateral file credenzas, credenzas and bridges. Includes grommet and installed horizontal wire management. Narrow end panels on left and right.

- *Not freestanding*

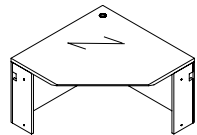

5-Sided Corner

DE484822	48 x 48 x 29	150	196	39	\$1915	\$2298
DE424222	42 x 42 x 29	150	150	30	\$1467	\$1761
DE363622	36 x 36 x 29	150	130	22	\$1395	\$1674

Connects to **22" D** connectables, returns, extended corners, storage/lateral file credenzas, credenzas and bridges. Includes grommet and installed horizontal wire management. Narrow end panels on left and right.

- *Not freestanding*

Required Specifications

Veneer Finish
Laminate Finish

Optional Specifications

Additional Grommet



D DUFFERIN

LEFT EXTENDED CORNERS

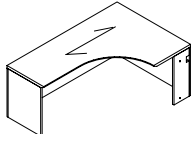

Left Extended Corner

MODEL#	DIMENSIONS D x W x H	FREIGHT CLASS	WT/LBS.	CUBIC FT.	VENEER/LAMINATE	ALL VENEER
DEKL964824	24-48 x 96 x 29	150	387	77	\$3188	\$3826
DEKL904824	24-48 x 90 x 29	150	363	73	\$2965	\$3558
DEKL844824	24-48 x 84 x 29	150	338	68	\$2961	\$3554
DEKL784824	24-48 x 78 x 29	150	314	63	\$2914	\$3497
DEKL724824	24-48 x 72 x 29	150	290	58	\$2732	\$3279
DEKL664824	24-48 x 66 x 29	150	266	52	\$2583	\$3100
DEKL604824	24-48 x 60 x 29	150	242	48	\$2393	\$2872

Extended worksurface on **left**. **Full end panel on left, narrow end panel on right.** Connects to Linking Bridges, Extended Corners and Connectable Tables.

RIGHT EXTENDED CORNERS

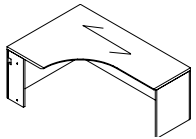

Right Extended Corner

DEKR489624	24-48 x 96 x 29	150	387	77	\$3188	\$3826
DEKR489024	24-48 x 90 x 29	150	363	73	\$2965	\$3558
DEKR488424	24-48 x 84 x 29	150	338	68	\$2961	\$3554
DEKR487824	24-48 x 78 x 29	150	314	63	\$2914	\$3497
DEKR487224	24-48 x 72 x 29	150	290	58	\$2732	\$3279
DEKR486624	24-48 x 66 x 29	150	266	52	\$2583	\$3100
DEKR486024	24-48 x 60 x 29	150	242	48	\$2393	\$2872

Extended worksurface on **right**. **Full end panel on right, narrow end panel on left.** Connects to Linking Bridges, Extended Corners and Connectable Tables.

FREESTANDING TABLES

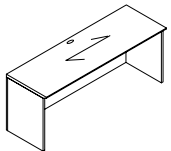

24" Deep Freestanding Table

DVT9624	24 x 96 x 29	150	213	39	\$1900	\$2280
DVT9024	24 x 90 x 29	150	199	36	\$1780	\$2136
DVT8424	24 x 84 x 29	150	186	34	\$1663	\$1996
DVT7824	24 x 78 x 29	150	173	31	\$1544	\$1853
DVT7224	24 x 72 x 29	150	160	29	\$1424	\$1709
DVT6624	24 x 66 x 29	150	146	27	\$1339	\$1607
DVT6024	24 x 60 x 29	150	133	24	\$1254	\$1505
DVT5424	24 x 54 x 29	150	128	22	\$1185	\$1422
DVT4824	24 x 48 x 29	125	120	19	\$1115	\$1338
DVT4224	24 x 42 x 29	125	104	17	\$944	\$1133
DVT3624	24 x 36 x 29	150	88	15	\$914	\$1097
DVT3024	24 x 30 x 29	125	82	12	\$896	\$1076
DVT2424	24 x 24 x 29	125	65	10	\$752	\$903

Two full end panels. **Cannot be connected on left or right side.**

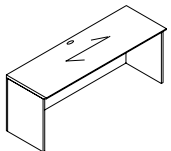

22" Deep Freestanding Table

DVT9622	22 x 96 x 29	150	193	35	\$1810	\$2172
DVT9022	22 x 90 x 29	150	181	33	\$1696	\$2036
DVT8422	22 x 84 x 29	150	169	31	\$1584	\$1901
DVT7822	22 x 78 x 29	150	157	29	\$1469	\$1763
DVT7222	22 x 72 x 29	150	145	27	\$1357	\$1629
DVT6622	22 x 66 x 29	150	138	24	\$1275	\$1530
DVT6022	22 x 60 x 29	150	130	22	\$1195	\$1434
DVT5422	22 x 54 x 29	125	123	20	\$1128	\$1354
DVT4822	22 x 48 x 29	125	115	18	\$1064	\$1277
DVT4222	22 x 42 x 29	125	100	16	\$899	\$1079
DVT3622	22 x 36 x 29	125	85	13	\$870	\$1044
DVT3022	22 x 30 x 29	125	80	11	\$852	\$1023
DVT2422	22 x 24 x 29	125	64	9	\$716	\$860

Two full end panels. **Cannot be connected on left or right side.**

Required Specifications

Veneer Finish
Laminate Finish

Optional Specifications

Grommet

CONNECTABLE TABLES

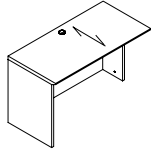

24" Deep Connectable Table - LEFT

MODEL#	DIMENSIONS	FREIGHT CLASS	WT/LBS.	CUBIC FT.	veneER/LAMINATE	ALL veneER
D x W x H						
DVL9624CG	24 x 96 x 29	150	200	39	\$2102	\$2523
DVL9024CG	24 x 90 x 29	150	187	36	\$1968	\$2362
DVL8424CG	24 x 84 x 29	150	174	34	\$1838	\$2206
DVL7824CG	24 x 78 x 29	150	162	31	\$1704	\$2045
DVL7224CG	24 x 72 x 29	150	149	29	\$1575	\$1890
DVL6624CG	24 x 66 x 29	150	141	27	\$1477	\$1773
DVL6024CG	24 x 60 x 29	150	132	24	\$1381	\$1658
DVL5424CG	24 x 54 x 29	150	121	22	\$1301	\$1562
DVL4824CG	24 x 48 x 29	125	115	19	\$1223	\$1468
DVL4224CG	24 x 42 x 29	150	99	17	\$1033	\$1240
DVL3624CG	24 x 36 x 29	150	83	15	\$996	\$1196
DVL3024CG	24 x 30 x 29	125	77	12	\$977	\$1173
DVL2424CG	24 x 24 x 29	125	61	10	\$820	\$984

Full end panel on left. Right narrow end panel connects to 24"D center/right connectable table; 24"D extended corners, 24"D 5-sided corners; Grommet in worksurface.

- To remove cross grain veneer pattern on top, delete suffix "CG" from the model number. Available as a special - no upcharge.

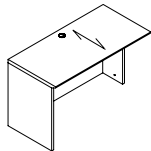

22" Deep Connectable Table - LEFT

DVL9622CG	22 x 96 x 29	150	187	39	\$2000	\$2400
DVL9022CG	22 x 90 x 29	150	175	36	\$1877	\$2253
DVL8422CG	22 x 84 x 29	150	163	34	\$1751	\$2102
DVL7822CG	22 x 78 x 29	150	152	31	\$1624	\$1949
DVL7222CG	22 x 72 x 29	150	140	29	\$1500	\$1800
DVL6622CG	22 x 66 x 29	150	133	27	\$1409	\$1691
DVL6022CG	22 x 60 x 29	150	125	24	\$1316	\$1580
DVL5422CG	22 x 54 x 29	150	113	22	\$1243	\$1492
DVL4822CG	22 x 48 x 29	125	110	19	\$1167	\$1401
DVL4222CG	22 x 42 x 29	150	95	17	\$985	\$1182
DVL3622CG	22 x 36 x 29	125	80	15	\$947	\$1137
DVL3022CG	22 x 30 x 29	125	75	12	\$932	\$1119
DVL2422CG	22 x 24 x 29	125	60	10	\$783	\$940

Full end panel on left. Right narrow end panel connects to 22"D center/right connectable table; 22"D 5-sided corners; Grommet in worksurface.

- To remove cross grain veneer pattern on top, delete suffix "CG" from the model number. Available as a special - no upcharge.

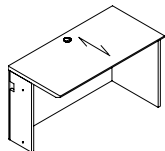

24" Deep Connectable Table - RIGHT

DVR9624CG	24 x 96 x 29	150	200	39	\$2102	\$2523
DVR9024CG	24 x 90 x 29	150	187	36	\$1968	\$2362
DVR8424CG	24 x 84 x 29	150	174	34	\$1838	\$2206
DVR7824CG	24 x 78 x 29	150	162	31	\$1704	\$2045
DVR7224CG	24 x 72 x 29	150	149	29	\$1575	\$1890
DVR6624CG	24 x 66 x 29	150	141	27	\$1477	\$1773
DVR6024CG	24 x 60 x 29	150	132	24	\$1380	\$1656
DVR5424CG	24 x 54 x 29	150	121	22	\$1301	\$1562
DVR4824CG	24 x 48 x 29	125	115	19	\$1224	\$1469
DVR4224CG	24 x 42 x 29	150	99	17	\$1033	\$1240
DVR3624CG	24 x 36 x 29	150	83	15	\$996	\$1196
DVR3024CG	24 x 30 x 29	125	77	12	\$977	\$1173
DVR2424CG	24 x 24 x 29	125	61	10	\$820	\$984

Full end panel on right. Left narrow end panel connects to 24"D center/left connectable table; 24"D extended corners, 24"D 5-sided corners; Grommet in worksurface.

- To remove cross grain veneer pattern on top, delete suffix "CG" from the model number. Available as a special - no upcharge.

Required Specifications

Veneer Finish
Laminate Finish

Optional Specifications

Additional Grommet

CONNECTABLE TABLES

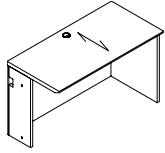

22" Deep Connectable Table - RIGHT

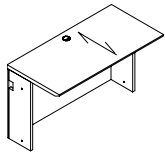

24" Deep Connectable Table

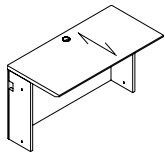

22" Deep Connectable Table

MODEL#	DIMENSIONS D x W x H	FREIGHT CLASS	WT/LBS.	CUBIC FT.	VENEER/LAMINATE	ALL VENEER
DVR9622CG	22 x 96 x 29	150	187	39	\$2000	\$2400
DVR9022CG	22 x 90 x 29	150	175	36	\$1877	\$2253
DVR8422CG	22 x 84 x 29	150	163	34	\$1751	\$2102
DVR7822CG	22 x 78 x 29	150	152	31	\$1624	\$1949
DVR7222CG	22 x 72 x 29	150	140	29	\$1500	\$1800
DVR6622CG	22 x 66 x 29	150	133	27	\$1409	\$1691
DVR6022CG	22 x 60 x 29	150	125	24	\$1316	\$1580
DVR5422CG	22 x 54 x 29	150	113	22	\$1243	\$1492
DVR4822CG	22 x 48 x 29	125	110	19	\$1167	\$1401
DVR4222CG	22 x 42 x 29	150	95	17	\$985	\$1182
DVR3622CG	22 x 36 x 29	125	80	15	\$947	\$1137
DVR3022CG	22 x 30 x 29	125	75	12	\$932	\$1119
DVR2422CG	22 x 24 x 29	125	60	10	\$783	\$940

Full end panel on right. Left narrow end panel connects to **22"D** center/left connectable table; **22"D** 5-sided corners; Grommet in worksurface.

- To remove cross grain veneer pattern on top, **delete suffix "CG"** from the model number. Available as a special - no upcharge.

DV9624CG	24 x 96 x 29	150	197	39	\$2051	\$2462
DV9024CG	24 x 90 x 29	150	185	36	\$1926	\$2312
DV8424CG	24 x 84 x 29	150	173	34	\$1797	\$2157
DV7824CG	24 x 78 x 29	150	160	31	\$1667	\$2001
DV7224CG	24 x 72 x 29	150	145	29	\$1538	\$1846
DV6624CG	24 x 66 x 29	150	136	27	\$1556	\$1868
DV6024CG	24 x 60 x 29	150	123	24	\$1343	\$1612
DV5424CG	24 x 54 x 29	150	119	22	\$1264	\$1517
DV4824CG	24 x 48 x 29	150	107	19	\$1186	\$1424
DV4224CG	24 x 42 x 29	150	91	17	\$996	\$1196
DV3624CG	24 x 36 x 29	150	76	15	\$959	\$1151
DV3024CG	24 x 30 x 29	150	70	12	\$940	\$1128
DV2424CG	24 x 24 x 29	150	53	10	\$788	\$946

Narrow end panels on left and right connects to **24"D** connectable table; **24"D** extended corners, **24"D** 5-sided corners; Grommet in worksurface.

- To remove cross grain veneer pattern on top, **delete suffix "CG"** from the model number. Available as a special - no upcharge.

DV9622CG	22 x 96 x 29	150	181	35	\$1954	\$2345
DV9022CG	22 x 90 x 29	150	169	33	\$1834	\$2201
DV8422CG	22 x 84 x 29	150	157	31	\$1709	\$2051
DV7822CG	22 x 78 x 29	150	145	29	\$1588	\$1906
DV7222CG	22 x 72 x 29	150	133	27	\$1463	\$1756
DV6622CG	22 x 66 x 29	150	126	24	\$1371	\$1646
DV6022CG	22 x 60 x 29	150	118	22	\$1283	\$1540
DV5422CG	22 x 54 x 29	150	111	20	\$1204	\$1445
DV4822CG	22 x 48 x 29	150	103	18	\$1130	\$1356
DV4222CG	22 x 42 x 29	150	88	16	\$945	\$1134
DV3622CG	22 x 36 x 29	150	73	13	\$913	\$1096
DV3022CG	22 x 30 x 29	125	68	11	\$894	\$1073
DV2422CG	22 x 24 x 29	150	52	9	\$750	\$900

Narrow end panels on left and right connects to **22"D** connectable table; **22"D** extended corners, **22"D** 5-sided corners; Grommet in worksurface.

- To remove cross grain veneer pattern on top, **delete suffix "CG"** from the model number. Available as a special - no upcharge.

Required Specifications

Veneer Finish
Laminate Finish

Optional Specifications

Additional Grommet

"D" ISLANDS

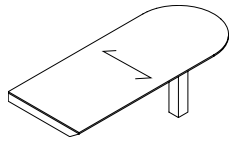

"D" Island with Monopost

MODEL#	DIMENSIONS D x W x H	FREIGHT CLASS	WT/LBS.	CUBIC FT.	VENEER/LAMINATE	ALL VENEER
DRD8436CG	36 x 84 x 29	250	135	51	N/A	\$1936
DRD7236CG	36 x 72 x 29	250	121	44	N/A	\$1658
DRD7230CG	30 x 72 x 29	250	99	36	N/A	\$1551
DRD6636CG	36 x 66 x 29	250	99	40	N/A	\$1551
DRD6030CG	30 x 60 x 29	250	83	30	N/A	\$1445

Attaches to edge of worksurfaces with Dufferin knife (molding) edge. Attaching hardware included. Shipped RTA (ready to assemble).

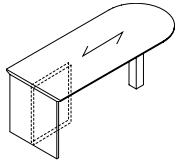

"D" Island - Full End Panel (T-Base) & Monopost

DDD8436	36 x 84 x 29	125	343	51	\$3076	\$3692
DDD7236	36 x 72 x 29	125	294	44	\$2635	\$3162
DDD7230	30 x 72 x 29	125	264	36	\$2449	\$2939
DDD6636	36 x 66 x 29	125	245	40	\$2449	\$2939
DDD6030	30 x 60 x 29	125	225	30	\$2354	\$2825

Connects to Linking Bridges or Executive Returns. Attaching hardware included. **Not freestanding.**

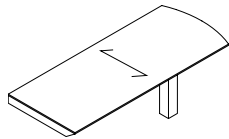

"D" Island with Monopost, Bow End

DRDBE8436CG	36 x 84 x 29	250	135	51	N/A	\$1936
DRDBE7236CG	36 x 72 x 29	250	121	44	N/A	\$1658
DRDBE7230CG	30 x 72 x 29	250	99	36	N/A	\$1551
DRDBE6636CG	36 x 66 x 29	250	99	40	N/A	\$1551
DRDBE6030CG	30 x 60 x 29	250	83	30	N/A	\$1445

Attaches to edge of worksurfaces with Dufferin knife (molding) edge. Attaching hardware included. Shipped RTA (ready to assemble).

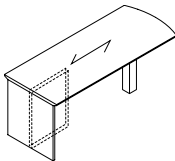

"D" Island - Full End Panel, Bow End (T-Base) & Monopost

DDDBE8436	36 x 84 x 29	125	343	51	\$3075	\$3690
DDDBE7236	36 x 72 x 29	125	294	44	\$2635	\$3162
DDDBE7230	30 x 72 x 29	125	264	36	\$2448	\$2938
DDDBE6636	36 x 66 x 29	125	245	40	\$2448	\$2938
DDDBE6030	30 x 60 x 29	125	225	30	\$2352	\$2823

Connects to Linking Bridges or Executive Returns. Attaching hardware included. **Not freestanding.**

BOAT SHAPED ISLANDS

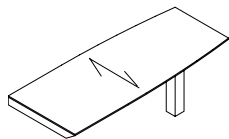

Boat Shaped Island with Monopost

DRDBS8442CG	42 x 84 x 29	250	179	59	N/A	\$2255
DRDBS8436CG	36 x 84 x 29	250	155	51	N/A	\$1936
DRDBS7236CG	36 x 72 x 29	250	141	44	N/A	\$1658
DRDBS7230CG	30 x 72 x 29	250	119	36	N/A	\$1551
DRDBS6636CG	36 x 66 x 29	250	119	40	N/A	\$1551
DRDBS6030CG	30 x 60 x 29	250	103	30	N/A	\$1445

Attaches to edge of worksurfaces with Dufferin knife (molding) edge. Attaching hardware included. Shipped RTA (ready to assemble).

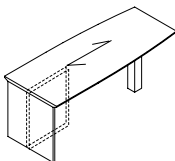

Boat Shaped Island - Full End Panel (T-Base) & Monopost

DDDBS8442	42 x 84 x 29	125	414	59	\$3641	\$4370
DDDBS8436	36 x 84 x 29	125	343	51	\$3075	\$3690
DDDBS7236	36 x 72 x 29	125	314	44	\$2635	\$3162
DDDBS7230	30 x 72 x 29	125	284	36	\$2448	\$2938
DDDBS6636	36 x 66 x 29	125	265	40	\$2448	\$2938
DDDBS6030	30 x 60 x 29	100	245	30	\$2352	\$2823

Connects to Linking Bridges or Executive Returns. Attaching hardware included. **Not freestanding.**

Required Specifications

Veneer Finish
Laminate Finish (Full End Panel models)
Monopost Finish

Optional Specifications

Grommet
Modesty Panel
Monopost (Base) Upgrade

D DUFFERIN

"P" ISLANDS

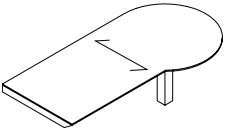

"P" Island - LEFT with Monopost

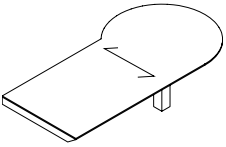

"P" Island - RIGHT with Monopost

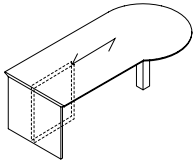

"P" Island - LEFT with Monopost (T-Base) & Monopost

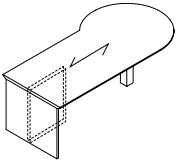

"P" Island - RIGHT with Monopost (T-Base) & Monopost

MODEL#	DIMENSIONS	FREIGHT CLASS	WT/LBS.	CUBIC FT.	VENEER/LAMINATE	ALL VENEER
--------	------------	---------------	---------	-----------	-----------------	------------

D x W x H

DRPL9642CG	42 x 96 x 29	250	239	68	N/A	\$2982
DRPL8442CG	42 x 84 x 29	250	209	59	N/A	\$2607
DRPL7242CG	42 x 72 x 29	250	143	51	N/A	\$2237

Attaches to edge of worksurfaces with Dufferin knife (molding) edge. Attaching hardware included. Shipped RTA (ready to assemble).

DRPR9642CG	42 x 96 x 29	250	239	68	N/A	\$2982
DRPR8442CG	42 x 84 x 29	250	209	59	N/A	\$2607
DRPR7242CG	42 x 72 x 29	250	143	51	N/A	\$2237

Attaches to edge of worksurfaces with Dufferin knife (molding) edge. Attaching hardware included. Shipped RTA (ready to assemble).

DTPL9642	42 x 96 x 29	125	440	68	\$2815	\$3378
DTPL8442	42 x 84 x 29	125	385	59	\$2463	\$2956
DTPL7242	42 x 72 x 29	125	319	51	\$2245	\$2694

Connects to Linking Bridges or Executive Returns. Attaching hardware included. **Not freestanding.**

DTPR9642	42 x 96 x 29	125	440	68	\$2815	\$3378
DTPR8442	42 x 84 x 29	125	385	59	\$2463	\$2956
DTPR7242	42 x 72 x 29	125	319	51	\$2245	\$2694

Connects to Linking Bridges or Executive Returns. Attaching hardware included. **Not freestanding.**

Required Specifications

Veneer Finish
Laminate Finish (Full End Panel models)
Monopost Finish

Optional Specifications

Grommet
Modesty Panel
Monopost (Base) Upgrade

PIANO DESKS	MODEL#	DIMENSIONS	FREIGHT CLASS	WT/LBS.	CUBIC FT.	veneER/LAMINATE	ALL veneER
-------------	--------	------------	---------------	---------	-----------	-----------------	------------

D x W x H

- Can be ordered as a shell or with pedestals.
- Components include a GM1 grommet in the top center position.
- Hand of Rectangular Desk is determined by location of pedestal from user side.
- Hand of "D" Top is determined by outward orientation of curved end from user projection.
- Hand of "P" Top is determined by outward orientation of conference end from user projection.
- Connectable Tables and Bridges - To remove cross grain veneer pattern on top, delete suffix "CG" from the model number. Available as a special - no upcharge.

Supporting Slab Joining Structure

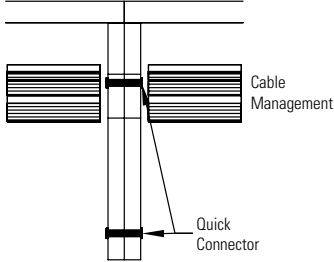

Piano Return (Right Hand Shown)

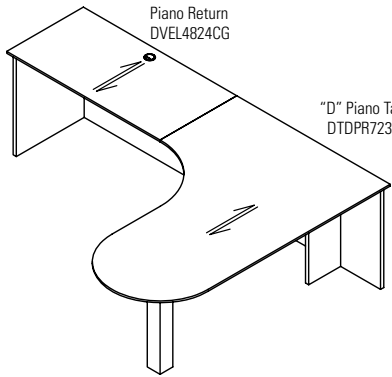
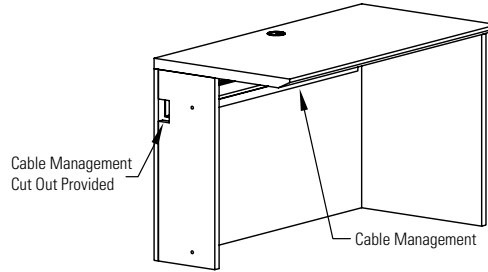

"D" Piano Table Desk
DTDPR72304824

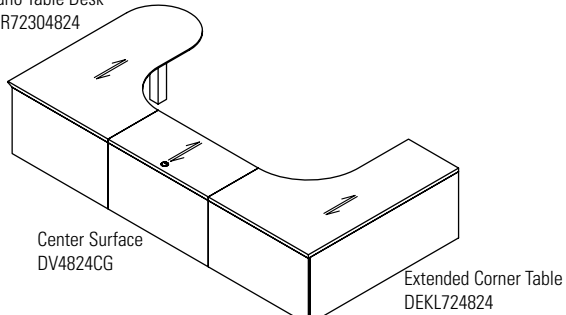

"D" ISLANDS (PIANO DESKS)

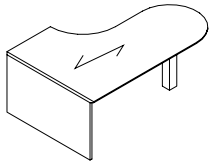

"D" Island LEFT - Full End Panel & Monopost, Piano Desk

DTDPL96304824	48 x 96 x 29	125	464	77	\$2919	\$3503
DTDPL84304824	48 x 84 x 29	150	406	68	\$2599	\$3119
DTDPL72304824	48 x 72 x 29	125	348	58	\$2276	\$2732

Extended island worksurface on the **left**. Narrow end panel on right connects to **24"D** returns or bridges for Piano Desks **Only** (see above). **Not freestanding**. Includes installed horizontal wire management.

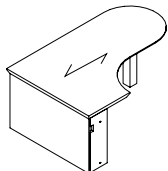

"D" Island RIGHT - Full End Panel & Monopost, Piano Desk

DTDPR96304824	48 x 96 x 29	125	464	77	\$2919	\$3503
DTDPR84304824	48 x 84 x 29	150	406	68	\$2599	\$3119
DTDPR72304824	48 x 72 x 29	125	348	58	\$2276	\$2732

Extended island worksurface on the **right**. Narrow end panel on left connects to **24"D** returns or bridges for Piano Desks **Only** (see above). **Not freestanding**. Includes installed horizontal wire management.

Required Specifications

Veneer Finish
Laminate Finish
Monopost Finish

Optional Specifications

Grommet
Modesty Panel
Monopost (Base) Upgrade

D DUFFERIN

BOAT SHAPED ISLANDS (PIANO DESKS)

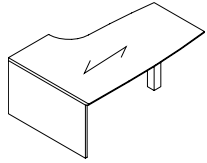

Boat Shaped Island LEFT - Full End Panel & Monopost, Piano Desk

MODEL#	DIMENSIONS D x W x H	FREIGHT CLASS	WT/LBS.	CUBIC FT.	VENEER/LAMINATE	ALL VENEER
DTBPL96304824	48 x 96 x 29	125	522	87	\$3471	\$4166
DTBPL84304824	48 x 84 x 29	125	457	76	\$3471	\$4166
DTBPL72304824	48 x 72 x 29	125	392	65	\$3030	\$3636

Extended island worksurface on the **left**. Narrow end panel on right connects to **24"D** returns or bridges **for Piano Desks Only** (see pg. 35). **Not freestanding**. Includes installed horizontal wire management.

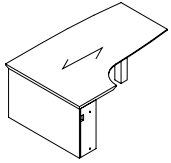

Boat Shaped Island RIGHT - Full End Panel & Monopost, Piano Desk

DTBPR96304824	48 x 96 x 29	125	522	87	\$3471	\$4166
DTBPR84304824	48 x 84 x 29	125	457	76	\$3471	\$4166
DTBPR72304824	48 x 72 x 29	125	392	65	\$3029	\$3635

Extended island worksurface on the **right**. Narrow end panel on left connects to **24"D** returns or bridges **for Piano Desks Only** (see pg. 35). **Not freestanding**. Includes installed horizontal wire management.

"P" ISLANDS (PIANO DESKS)

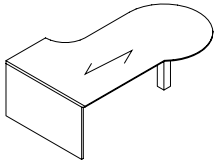

"P" Shaped Island LEFT - Full End Panel & Monopost, Piano Desk

DTPPL96424824	60 x 96 x 29	150	580	97	\$3331	\$3998
DTPPL84424824	60 x 84 x 29	150	508	85	\$2980	\$3576
DTPPL72424824	60 x 72 x 29	150	435	73	\$2762	\$3315

Extended island worksurface on the **left**. Narrow end panel on right connects to **24"D** returns or bridges **for Piano Desks Only** (see pg. 35). **Not freestanding**. Includes installed horizontal wire management.

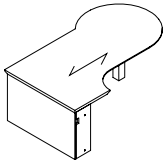

Boat Shaped Island RIGHT - Full End Panel & Monopost, Piano Desk

DTPPR96424824	60 x 96 x 29	150	580	97	\$3329	\$3995
DTPPR84424824	60 x 84 x 29	150	508	85	\$2980	\$3576
DTPPR72424824	60 x 72 x 29	150	435	73	\$2762	\$3315

Extended island worksurface on the **right**. Narrow end panel on left connects to **24"D** returns or bridges **for Piano Desks Only** (see pg. 35). **Not freestanding**. Includes installed horizontal wire management.

DELTA ISLANDS (PIANO DESKS)

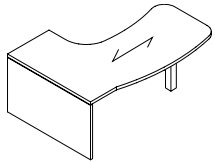

Delta Island LEFT - Full End Panel & Monopost, Piano Desk

DBTHPL96304824	54 x 96 x 29	125	531	87	\$3158	\$3790
DBTHPL84304824	54 x 84 x 29	125	464	76	\$2807	\$3369
DBTHPL72304824	54 x 72 x 29	125	398	65	\$2590	\$3108

Extended island worksurface on the **left**. Narrow end panel on right connects to **24"D** returns or bridges **for Piano Desks Only** (see pg. 35). **Not freestanding**. Includes installed horizontal wire management.

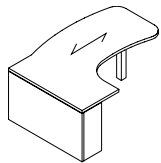

Delta Island RIGHT - Full End Panel & Monopost, Piano Desk

DBTHPR96304824	54 x 96 x 29	125	531	87	\$3158	\$3790
DBTHPR84304824	54 x 84 x 29	125	464	76	\$2807	\$3369
DBTHPR72304824	54 x 72 x 29	125	398	65	\$2590	\$3108

Extended island worksurface on the **right**. Narrow end panel on left connects to **24"D** returns or bridges **for Piano Desks Only** (see pg. 35). **Not freestanding**. Includes installed horizontal wire management.

Required Specifications

Veneer Finish
Laminate Finish
Monopost Finish

Optional Specifications

Grommet
Modesty Panel
Monopost (Base) Upgrade

CONNECTABLE TABLES - LEFT (FOR PIANO DESKS)

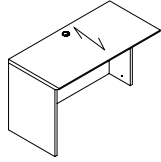

24" Deep Connectable Table - LEFT
For Piano Desk

MODEL#	DIMENSIONS D x W x H	FREIGHT CLASS	WT/LBS.	CUBIC FT.	veneER/LAMINATE	ALL veneER
DVEL9624CG	24 x 96 x 29	150	200	39	\$2181	\$2618
DVEL9024CG	24 x 90 x 29	150	187	36	\$2047	\$2457
DVEL8424CG	24 x 84 x 29	150	174	34	\$1908	\$2290
DVEL7824CG	24 x 78 x 29	150	162	31	\$1774	\$2129
DVEL7224CG	24 x 72 x 29	150	149	29	\$1639	\$1967
DVEL6624CG	24 x 66 x 29	150	141	27	\$1533	\$1840
DVEL6024CG	24 x 60 x 29	150	132	24	\$1436	\$1724
DVEL5424CG	24 x 54 x 29	150	121	22	\$1352	\$1623
DVEL4824CG	24 x 48 x 29	125	115	19	\$1274	\$1529
DVEL4224CG	24 x 42 x 29	150	99	17	\$1070	\$1284
DVEL3624CG	24 x 36 x 29	150	83	15	\$1038	\$1246
DVEL3024CG	24 x 30 x 29	125	77	12	\$1111	\$1334
DVEL2424CG	24 x 24 x 29	125	61	10	\$852	\$1023

Full end panel on left. Right narrow end panel connects to 24"D right connectable table, "D" islands, Boat shaped islands, "P" islands or Delta islands with "T" bases **for Piano Desks Only**. Grommet in worksurface. Shipped RTA (ready to assemble).

- To remove cross grain veneer pattern on top, **delete suffix "CG"** from the model number. Available as a special - no upcharge.

CONNECTABLE TABLES - RIGHT (FOR PIANO DESKS)

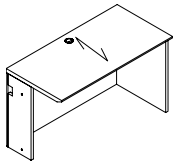

24" Deep Connectable Table - RIGHT
For Piano Desk

DVER9624CG	24 x 96 x 29	150	200	39	\$2181	\$2618
DVER9024CG	24 x 90 x 29	150	187	36	\$2047	\$2457
DVER8424CG	24 x 84 x 29	150	174	34	\$1908	\$2290
DVER7824CG	24 x 78 x 29	150	162	31	\$1774	\$2129
DVER7224CG	24 x 72 x 29	150	149	29	\$1639	\$1967
DVER6624CG	24 x 66 x 29	150	141	27	\$1533	\$1840
DVER6024CG	24 x 60 x 29	150	132	24	\$1436	\$1724
DVER5424CG	24 x 54 x 29	150	121	22	\$1352	\$1623
DVER4824CG	24 x 48 x 29	125	115	19	\$1274	\$1529
DVER4224CG	24 x 42 x 29	150	99	17	\$1070	\$1284
DVER3624CG	24 x 36 x 29	150	83	15	\$1038	\$1246
DVER3024CG	24 x 30 x 29	125	77	12	\$1028	\$1234
DVER2424CG	24 x 24 x 29	125	61	10	\$852	\$1023

Full end panel on right. Left narrow end panel connects to 24"D left connectable table, "D" islands, Boat shaped islands, "P" islands or Delta islands with "T" bases **for Piano Desks Only**. Grommet in worksurface. Shipped RTA (ready to assemble).

- To remove cross grain veneer pattern on top, **delete suffix "CG"** from the model number. Available as a special - no upcharge.

BRIDGES (FOR PIANO DESKS)

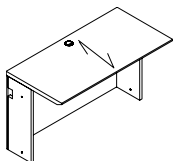

Flush Bridge

DBTN4824CG	24 x 48 x 29	125	116	19	\$1093	\$1312
DBTN4224CG	24 x 42 x 29	92.5	102	17	\$917	\$1101
DBTN3624CG	24 x 36 x 29	150	87	15	\$880	\$1056
DBTN3024CG	24 x 30 x 29	125	73	12	\$862	\$1035
DBTN2424CG	24 x 24 x 29	150	58	10	\$723	\$868
DBTN1824CG	24 x 18 x 29	150	43	8	\$542	\$651
DBTN1224CG	24 x 12 x 29	150	29	5	\$362	\$435

Full end panel on both sides connects to 24"D worksurfaces, "D" islands, Boat shaped islands, "P" islands or Delta islands with "T" bases **for Piano Desks Only**. Grommet in worksurface. Shipped RTA (ready to assemble).

- To remove cross grain veneer pattern on top, **delete suffix "CG"** from the model number. Available as a special - no upcharge.

Required Specifications

Veneer Finish
Laminate Finish

Optional Specifications

Additional Grommet

D DUFFERIN

TABLE DESKS

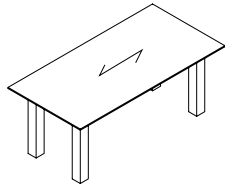
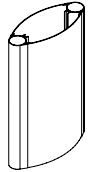

Table Desk

MODEL#	DIMENSIONS D x W x H	FREIGHT CLASS	WT/LBS.	CUBIC FT.	VENEER/LAMINATE	ALL VENEER
DTB8442	42 x 84 x 29	150	272	59	N/A	\$5202
DTB7842	42 x 78 x 29	150	253	55	N/A	\$4831
DTB7236	36 x 72 x 29	150	205	44	N/A	\$3823
DTB7230	30 x 72 x 29	150	192	36	N/A	\$3750
DTB6636	36 x 66 x 29	150	192	40	N/A	\$3750
DTB6630	30 x 66 x 29	150	188	33	N/A	\$3678
DTB6030	30 x 60 x 29	150	171	30	N/A	\$3504

Four 4" square metal legs. Includes centered pencil drawer.

MONOPOST (BASE) UPGRADES



Elliptical Base Upgrade

TE18	5 x 18 x 28	70	30	2	N/A	\$871
------	-------------	----	----	---	-----	--------------

To replace one standard monopost on Islands for Piano Desks ONLY. Must specify at time of order. **Can not be retrofitted in the field.**

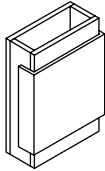

Rectangular Base Upgrade

TPML18	8 x 18 x 28	70	36	2	\$913	\$1096
--------	-------------	----	----	---	--------------	---------------

To replace one standard monopost on Islands for Piano Desks ONLY. Must specify at time of order. **Can not be retrofitted in the field.**

MODESTY PANEL OPTIONS

LIST PRICE

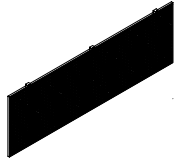

Metal Modesty Panel Upgrade

CMP72	1 x 67 x 18	--	20	1	\$1096
CMP66	1 x 61 x 18	--	18	1	\$1061
CMP60	1 x 55 x 18	--	16	1	\$1044
CMP54	1 x 49 x 18	--	14	1	\$1026
CMP48	1 x 43 x 18	--	13	1	\$1011

Straight modesty panel. Attaches to underside of worksurface. **Can not be retrofitted in the field.**

• **Available in Black (E) and Tungsten (K). Please Specify.**

- CMP72 - Specify on 96" x 42" "P" Top Islands, 96" x 48" Islands for Piano Desks or 96" x 36" Delta Islands.
- CMP66 - Specify on 84" x 36" "D" Top Islands.
- CMP60 - Specify on 84" x 42" "P" Top Islands or 84" x 48" Islands for Piano Desks.
- CMP54 - Specify on 72" x 36" or 72" x 30" "D" Top Islands, 72" x 36" or 72" x 30" Boat Shaped Islands.
- CMP48 - Specify on 66" x 36", 60" x 30" "D" Top Islands, 72" x 42" "P" Top Islands or 72" x 48" Islands for Piano Desks.

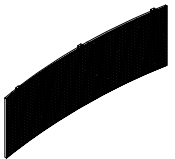

Metal Modesty Panel Upgrade, Curved

CMMP72	0.50 x 67 x 18	--	20	1	\$1096
CMMP66	0.50 x 61 x 18	--	18	1	\$1061
CMMP60	0.50 x 55 x 18	--	16	1	\$1044
CMMP54	0.50 x 49 x 18	--	14	1	\$1026
CMMP48	0.50 x 43 x 18	--	13	1	\$1011

Curved modesty panel. Attaches to underside of worksurface. **Can not be retrofitted in the field.**

• **Available in Black (E) and Tungsten (K). Please Specify.**

- CMMP72 - Specify on 96" x 42" "P" Top Islands, 96" x 48" Islands for Piano Desks or 96" x 36" Delta Islands.
- CMMP66 - Specify on 84" x 36" "D" Top Islands.
- CMMP60 - Specify on 84" x 42" "P" Top Islands or 84" x 48" Islands for Piano Desks.
- CMMP54 - Specify on 72" x 36" or 72" x 30" "D" Top Islands, 72" x 36" or 72" x 30" Boat Shaped Islands.
- CMMP48 - Specify on 66" x 36", 60" x 30" "D" Top Islands, 72" x 42" "P" Top Islands or 72" x 48" Islands for Piano Desks.

Required Specifications

Veneer Finish
Laminate Finish
Metal Finish (Table Desk legs, Modesty Panels)

Optional Specifications

Grommet (Table Desk)

MODESTY PANEL OPTIONS

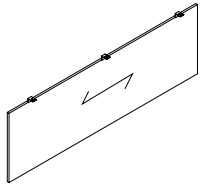

Veneer Modesty Panel Upgrade

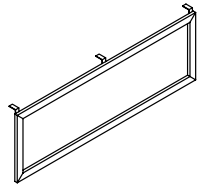

Glass Modesty Panel Upgrade

MODEL# DIMENSIONS FREIGHT CLASS WT/LBS. CUBIC FT. LIST PRICE

D x W x H

CMP72W	0.75 x 67 x 18	--	20	1	\$1096
CMP66W	0.75 x 61 x 18	--	18	1	\$1061
CMP60W	0.75 x 55 x 18	--	16	1	\$1044
CMP54W	0.75 x 49 x 18	--	14	1	\$1026
CMP48W	0.75 x 43 x 18	--	13	1	\$1011

Straight modesty panel. Attaches to underside of worksurface. **Can not be retrofitted in the field**

- CMP72W - Specify on "P" Top Islands or 96" x 48" Islands for Piano Desks.
- CMP66W - Specify on 84" x 36" "D" Top Islands.
- CMP60W - Specify on 84" x 42" "P" Top Islands or 84" x 48" Islands for Piano Desks.
- CMP54W - Specify on 72" x 30" "D" Top Islands.
- CMP48W - Specify on 66" x 36" , 60" x 30" "D" Top Islands, 72" x 42" "P" Top Islands or 72" x 48" Islands for Piano Desks.

CMP72G	0.75 x 67 x 18	--	20	1	\$1681
CMP66G	0.75 x 61 x 18	--	18	1	\$1589
CMP60G	0.75 x 55 x 18	--	16	1	\$1451
CMP54G	0.75 x 49 x 18	--	14	1	\$1352
CMP48G	0.75 x 43 x 18	--	13	1	\$1291

Straight modesty panel. Translucent, screened glass. Aluminum box frame construction in Tungsten Only. Attaches to underside of worksurface. **Can not be retrofitted in the field.**

- CMP72G - Specify on "P" Top Islands or 96" x 48" Islands for Piano Desks.
- CMP66G - Specify on 84" x 36" "D" Top Islands.
- CMP60G - Specify on 84" x 42" "P" Top Islands or 84" x 48" Islands for Piano Desks.
- CMP54G - Specify on 72" x 30" "D" Top Islands.
- CMP48G - Specify on 66" x 36" , 60" x 30" "D" Top Islands, 72" x 42" "P" Top Islands or 72" x 48" Islands for Piano Desks.
- Tungsten finish on the aluminum box frame closely resembles the existing Tungsten finish.

SIDE-BY-SIDE COMPONENTS

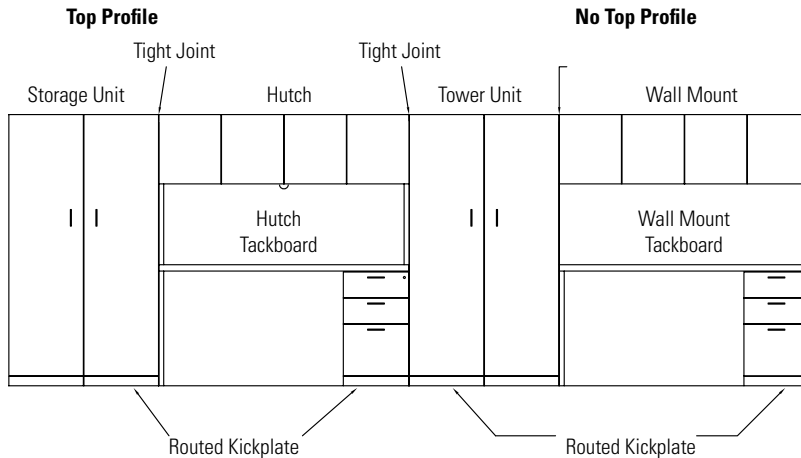

Required Specifications

Veneer Finish (Veneer Modesty Panel)

D DUFFERIN

MODULAR PEDESTALS

MODEL#

DIMENSIONS

FREIGHT CLASS

WT/LBS.

CUBIC FT.

VENEER/LAMINATE

ALL VENEER

D x W x H

- When using Storage Shells, laminate gables will show.
- Credenza shell cannot be completely filled up with storage shells to create a full storage credenza.
- Handle style must be specified.

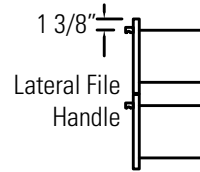
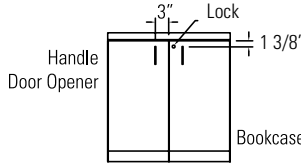
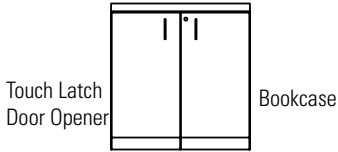
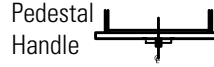
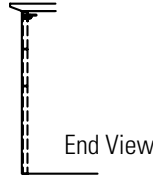
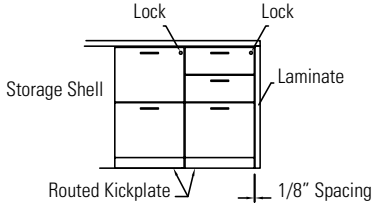

STORAGE SHELLS

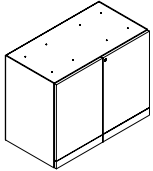

Storage Shell

DWG	19.1 x 36.75 x 28	92.5	115	11	\$1068	\$1282
DWM	19.1 x 31.625 x 28	92.5	96	9	\$945	\$1134

For use **under a freestanding worksurface (22", 24", 30" or 36"D)**. Top drilled to attach to worksurface. One adjustable shelf. **Standard with lock.**

- **Unfinished top and back**

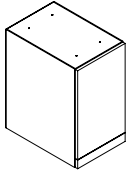

Storage Shell - LEFT

DWWIL	23 x 15.6 x 28	100	53	6	\$949	\$1139
DWIL	19.1 x 15.6 x 28	100	45	5	\$784	\$941

For use **under a freestanding worksurface (22", 24", 30" or 36"D)**. Top drilled to attach to worksurface. One adjustable shelf. Handle is on the **right**, door opens to the **left**.

- For 22" or 24"D worksurface, order **DWIL**. For 30" or 36"D worksurface, order **DWWIL**.

- **Unfinished top and back**

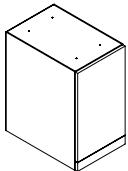

Storage Shell - RIGHT

DWWIR	23 x 15.6 x 28	100	53	6	\$949	\$1139
DWIR	19.1 x 15.6 x 28	100	45	5	\$784	\$941

For use **under a freestanding worksurface (22", 24", 30" or 36"D)**. Top drilled to attach to worksurface. One adjustable shelf. Handle is on the **left**, door opens to the **right**.

- For 22" or 24"D worksurface, order **DWIR**. For 30" or 36"D worksurface, order **DWWIR**.

- **Unfinished top and back**

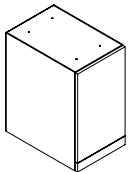

Storage Shell - LEFT
Eight Storage Slot Shelves

DWWIL8S	23 x 15.6 x 28	125	45	6	\$1299	\$1559
DWIL8S	19.1 x 15.6 x 28	125	37	5	\$1129	\$1355

For use **under a freestanding worksurface (22", 24", 30" or 36"D)**. Top drilled to attach to worksurface. Eight adjustable storage slot shelves. Handle is on the **right**, door opens to the **left**.

- For 22" or 24"D worksurface, order **DWIL8S**. For 30" or 36"D worksurface, order **DWWIL8S**.

- **Unfinished top and back**

Required Specifications

Veneer Finish (doors)
Laminate Finish (body)
Handle Style

Optional Specifications

Lock

STORAGE SHELLS

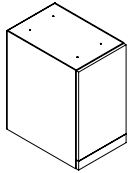

Storage Shell - RIGHT
Eight Storage Slot Shelves

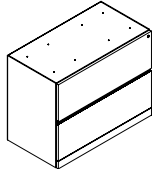

File/File Shell - Lateral

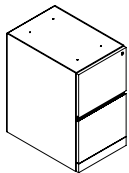

File/File Shell - Vertical

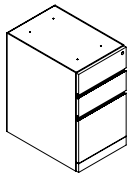

Box/Box/File Shell - Vertical

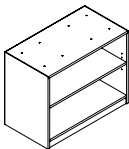

Open Shelving Shell

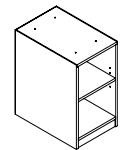

Open Shelving Shell

MODEL#	DIMENSIONS D x W x H	FREIGHT CLASS	WT/LBS.	CUBIC FT.	VENEER/LAMINATE	ALL VENEER
DWWIR8S	23 x 15.6 x 28	125	45	6	\$1299	\$1559
DWIR8S	19.1 x 15.6 x 28	125	37	5	\$1129	\$1355

For use **under a freestanding worksurface (22", 24", 30" or 36"D)**. Top drilled to attach to worksurface. Eight adjustable storage slot shelves. Handle is on the **left**, door opens to the **right**.

- For 22" or 24"D worksurface, order **DWIR8S**. For 30" or 36"D worksurface, order **DWWIR8S**.
- **Unfinished top and back**

DWF	19.1 x 36.75 x 28	92.5	115	11	\$1531	\$1838
DWN	19.1 x 31.625 x 28	92.5	96	9	\$1340	\$1608

For use **under a freestanding worksurface (22", 24", 30" or 36"D)**. Top drilled to attach to worksurface. **Two lateral file drawers**. Lock secures all drawers. Front-to-back letter and side-to-side letter/legal filing capability. Side-to-side file bars included.

- **Unfinished top and back**

LETTER

DWWE	23 x 15.6 x 28	85	72	6	\$1180	\$1416
DWE	19.1 x 15.6 x 28	85	70	5	\$1027	\$1233

LEGAL

DWWLE	23 x 18.5 x 28	85	85	7	\$1417	\$1701
DWLE	19.1 x 18.5 x 28	85	83	6	\$1233	\$1480

For use **under a freestanding worksurface (22", 24", 30" or 36"D)**. Top drilled to attach to worksurface. **Two file drawers**. Lock secures all drawers.

- For 22" or 24"D worksurface, order **DWE** or **DWLE**. For 30" or 36"D worksurface, order **DWWE** or **DWWLE**.
- **Unfinished top and back**

LETTER

DWWD	23 x 15.6 x 28	85	72	6	\$1180	\$1416
DWD	19.1 x 15.6 x 28	85	70	5	\$1027	\$1233

LEGAL

DWWLD	23 x 18.5 x 28	85	85	7	\$1417	\$1701
DWLD	19.1 x 18.5 x 28	85	83	6	\$1233	\$1480

For use **under a freestanding worksurface (22", 24", 30" or 36"D)**. Top drilled to attach to worksurface. **Two box and one file drawers**. One pencil tray. Lock secures all drawers.

- For 22" or 24"D worksurface, order **DWD** or **DWLD**. For 30" or 36"D worksurface, order **DWWD** or **DWWLD**.
- **Unfinished top and back**

DWOB36	19.1 x 36.75 x 28	100	92	11	\$807	\$969
DWOB30	19.1 x 31.625 x 28	100	77	9	\$715	\$858

For use **under a freestanding worksurface (22", 24", 30" or 36"D)**. Top drilled to attach to worksurface. One adjustable veneer shelf.

- **Unfinished top and back**

DWWQ	23 x 15.6 x 28	125	45	6	\$835	\$1002
DWQ	19.1 x 15.6 x 28	125	37	5	\$691	\$830

For use **under a freestanding worksurface (22", 24", 30" or 36"D)**. Top drilled to attach to worksurface. One adjustable veneer shelf.

- For 22" or 24"D worksurface, order **DWQ**. For 30" or 36"D worksurface, order **DWWQ**.
- **Unfinished top and back**

Required Specifications

Veneer Finish (doors, drawer fronts, open shelves)
Laminate Finish (body)
Handle Style

Optional Specifications

Additional Lock (Vertical File Shells)

STORAGE SHELLS

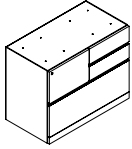

Mixed Storage Shell - LEFT

MODEL#	DIMENSIONS D x W x H	FREIGHT CLASS	WT/LBS.	CUBIC FT.	VENEER/LAMINATE	ALL VENEER
DWZL	19.1 x 36.75 x 28	92.5	115	11	\$1778	\$2134

For use **under a freestanding worksurface (22", 24", 30" or 36"D)**. Top drilled to attach to worksurface. One file drawer on **left**, two box drawers on **right** and one lateral file drawer on bottom. File drawer and lateral file drawer lock. One pencil tray. Front-to-back and side-to-side filing. **Not for stacking materials on lateral file drawer bottom.**

- **Unfinished top and back**

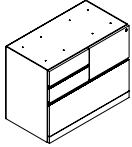

Mixed Storage Shell - RIGHT

DWZR	19.1 x 36.75 x 28	92.5	115	11	\$1778	\$2134
------	-------------------	------	-----	----	---------------	---------------

For use **under a freestanding worksurface (22", 24", 30" or 36"D)**. Top drilled to attach to worksurface. One file drawer on **right**, two box drawers on **left** and one lateral file drawer on bottom. File drawer and lateral file drawer lock. One pencil tray. Front-to-back and side-to-side filing. **Not for stacking materials on lateral file drawer bottom.**

- **Unfinished top and back**

STORAGE MODULES - (FREESTANDING)

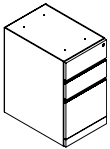

Box/Box/File Freestanding Pedestal

DWDB	19.8 x 15.5 x 28	85	70	5	\$1114	\$1337
DWWDB	23.8 x 15.5 x 28	300	75	6	\$1283	\$1540

Two box and one file drawer. One pencil tray. Lock secures all drawers. Finished back.

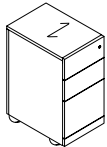

Box/Box/File Module, Mobile

DWDM	19.8 x 15.5 x 28	85	70	5	\$1198	\$1438
DWWDM	23.8 x 15.5 x 28	300	75	6	\$1378	\$1654

Two box and one file drawer. One pencil tray. Lock secures all drawers. Casters.

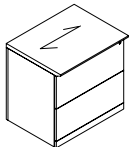

File/File Module, Lateral

DF3624	24 x 36 x 29	85	184	15	\$2132	\$2559
DN3024	24 x 30 x 29	85	153	12	\$1866	\$2240
DF3622	22 x 36 x 29	85	170	13	\$1953	\$2344
DN3022	22 x 30 x 29	85	142	11	\$1711	\$2054

Two lateral file drawers. Lock secures all drawers. Front-to-back letter and side-to-side letter/legal filing capability. Side-to-side file bars included.

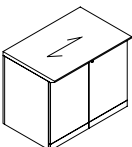

Storage Cabinet w/Doors

DBD3624	24 x 36 x 29	92.5	152	15	\$1332	\$1599
DBD3024	24 x 30 x 29	92.5	127	12	\$1165	\$1398
DBD3622	22 x 36 x 29	92.5	140	13	\$1220	\$1464
DBD3022	22 x 30 x 29	92.5	117	11	\$1068	\$1282

Includes one adjustable shelf. Standard with lock.

Required Specifications

Veneer Finish (doors, drawer fronts, tops)
Laminate Finish (top/body)
Handle Style

STORAGE MODULES - (FREESTANDING)

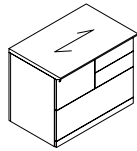

Mixed Storage Cabinet - LEFT

MODEL#	DIMENSIONS D x W x H	FREIGHT CLASS	WT/LBS.	CUBIC FT.	veneer/LAMINATE	ALL VENEER
DZL3624	24 x 36 x 29	85	184	15	\$2121	\$2546
DZL3622	22 x 36 x 29	85	170	13	\$1945	\$2334

One file drawer on the **left**, two box drawers on the **right** and one lateral file drawer on the bottom. File drawer and lateral file drawer lock. One pencil tray. Front-to-back and side-to-side filing. Not for stacking materials on lateral file drawer bottom.

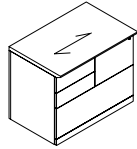

Mixed Storage Cabinet - RIGHT

DZR3624	24 x 36 x 29	85	184	15	\$2121	\$2546
DZR3622	22 x 36 x 29	85	170	13	\$1945	\$2334

One file drawer on the **right**, two box drawers on the **left** and one lateral file drawer on the bottom. File drawer and lateral file drawer lock. One pencil tray. Front-to-back and side-to-side filing. Not for stacking materials on lateral file drawer bottom.

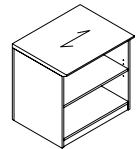

Open Storage Cabinet

DOB3624	24 x 36 x 29	100	123	15	\$1027	\$1233
DOB3024	24 x 30 x 29	100	103	12	\$900	\$1080
DOB3622	22 x 36 x 29	100	115	13	\$944	\$1133
DOB3022	22 x 30 x 29	100	96	11	\$825	\$990

One fixed and **one** adjustable veneer shelf. Shelves are 3/4" thick.

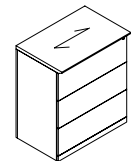

Three File Module

DF36243	24 x 36 x 42	92.5	231	21	\$2577	\$3093
DN30243	24 x 30 x 42	92.5	193	18	\$2260	\$2712
DF36223	22 x 36 x 42	92.5	212	19	\$2385	\$2862
DN30223	22 x 30 x 42	92.5	176	16	\$2092	\$2511

Three lateral file drawers. Lock secures all drawers. Front-to-back and side-to-side letter/legal filing capability. Side-to-side file bars included.

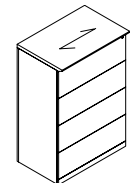

Four File Module

DF36244	24 x 36 x 54	92.5	297	27	\$3410	\$4092
DN30244	24 x 30 x 54	92.5	248	23	\$2911	\$3494
DF36224	22 x 36 x 54	92.5	270	25	\$2906	\$3488
DN30224	22 x 30 x 54	92.5	225	21	\$2547	\$3057

Four lateral file drawers. Lock secures all drawers. Front-to-back and side-to-side letter/legal filing capability. Side-to-side file bars included.

STORAGE MODULES - 48" HIGH (FREESTANDING)

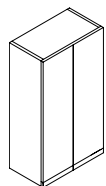

Storage Cabinet w/Doors

D1D22H48	22 x 36 x 48	150	107	22	\$2055	\$2466
D1D22W30H48	22 x 30 x 48	150	90	19	\$2008	\$2410
D1D22W24H48	22 x 24 x 48	150	72	15	\$1968	\$2362
D1D20H48	20 x 36 x 48	150	97	20	\$1869	\$2243
D1D20W30H48	20 x 30 x 48	150	81	17	\$1830	\$2196
D1D20W24H48	20 x 24 x 48	150	63	13	\$1789	\$2147

Includes four adjustable shelves.

Required Specifications

Veneer Finish
Laminate Finish (body)
Handle Style

Optional Specifications

Lock (Storage Cabinet with Doors)
Veneer Top (Storage Cabinet with Doors)

D DUFFERIN

STORAGE MODULES - 48" HIGH (FREESTANDING)

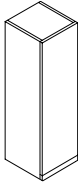

Storage Cabinet w/Door - LEFT

MODEL#	DIMENSIONS D x W x H	FREIGHT CLASS	WT/LBS.	CUBIC FT.	VENEER/LAMINATE	ALL VENEER
D1D22W18H48L	22 x 18 x 48	150	60	11	\$1297	\$1557
D1D22W16H48L	22 x 16 x 48	150	54	10	\$1153	\$1384
D1D20W18H48L	20 x 18 x 48	125	60	10	\$1181	\$1418
D1D20W16H48L	20 x 16 x 48	125	54	9	\$1047	\$1257

Includes three adjustable shelves. Handle is on the **right**, door opens to the **left**.

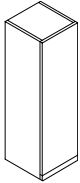

Storage Cabinet w/Door - RIGHT

D1D22W18H48R	22 x 18 x 48	150	60	11	\$1297	\$1557
D1D22W16H48R	22 x 16 x 48	150	54	10	\$1153	\$1384
D1D20W18H48R	20 x 18 x 48	125	60	10	\$1181	\$1418
D1D20W16H48R	20 x 16 x 48	125	54	9	\$1047	\$1257

Includes three adjustable shelves. Handle is on the **left**, door opens to the **right**.

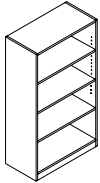

Open Storage Cabinet

D7D22W36H48	22 x 36 x 48	150	118	22	\$1621	\$1946
D7D22W30H48	22 x 30 x 48	150	98	19	\$1204	\$1445
D7D22W24H48	22 x 24 x 48	150	78	15	\$959	\$1151
D7D22W18H48	22 x 18 x 48	150	59	11	\$806	\$968
D7D20W36H48	20 x 36 x 48	150	108	20	\$1473	\$1768
D7D20W30H48	20 x 30 x 48	150	90	17	\$1093	\$1312
D7D20W24H48	20 x 24 x 48	100	72	13	\$1069	\$1283
D7D20W18H48	20 x 18 x 48	150	54	10	\$769	\$923

One fixed and **three** adjustable veneer shelves. Shelves are 3/4" thick.

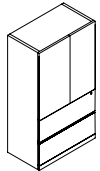

Two File Module w/Doors

D13D22H48	22 x 36 x 48	150	117	23	\$2190	\$2628
D13D22W30H48	22 x 30 x 48	150	101	19	\$1982	\$2379
D13H48	20 x 36 x 48	150	107	23	\$2098	\$2518
D13W30H48	20 x 30 x 48	150	91	19	\$2565	\$3078

Two lateral file drawers on bottom. Includes two adjustable shelves. Lower lock secures two file drawers. Front-to-back and side-to-side filing. **Not for stacking materials on lateral file drawer bottom.**



Two File Module w/Door - LEFT

D17D22H48L	22 x 16 x 48	125	97	13	\$1625	\$1950
D17D20H48L	20 x 16 x 48	125	88	13	\$1482	\$1779

Two file drawers on bottom. Includes two adjustable shelves. Lower lock secures two file drawers. Handle is on the **right**, door opens to the **left**.



Two File Module w/Door - RIGHT

D17D22H48R	22 x 16 x 48	125	97	13	\$1625	\$1950
D17D20H48R	20 x 16 x 48	125	88	13	\$1482	\$1779

Two file drawers on bottom. Includes two adjustable shelves. Lower lock secures two file drawers. Handle is on the **left**, door opens to the **right**.

Required Specifications

Veneer Finish (doors, drawer fronts)
Laminate Finish (top/body)
Handle Style (models with doors)

Optional Specifications

Lock (models with doors)
Veneer Top

STORAGE SHELLS

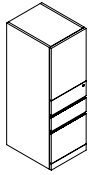

Box/Box/File Module w/Door - LEFT

MODEL#	DIMENSIONS D x W x H	FREIGHT CLASS	WT/LBS.	CUBIC FT.	VENEER/LAMINATE	ALL VENEER
D18D22H48L	22 x 16 x 48	125	64	9	\$1625	\$1950
D18D20H48L	20 x 16 x 48	125	59	9	\$1482	\$1779

Two box drawers and one file drawer on bottom. Includes two adjustable shelves. Lower lock secures all drawers. Handle is on the **right**, door opens to the **left**.

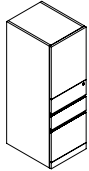

Box/Box/File Module w/Door - RIGHT

D18D22H48R	22 x 16 x 48	125	64	9	\$1625	\$1950
D18D20H48R	20 x 16 x 48	125	59	9	\$1482	\$1779

Two box drawers and one file drawer on bottom. Includes two adjustable shelves. Lower lock secures all drawers. Handle is on the **left**, door opens to the **right**.

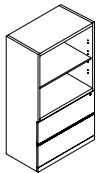

Two File Module w/Open Shelf

D12D22H48	22 x 36 x 48	150	117	23	\$2056	\$2468
D12D22W30H48	22 x 30 x 48	150	101	19	\$1778	\$2134
D12H48	20 x 36 x 48	150	107	23	\$1973	\$2368
D12W30H48	20 x 30 x 48	150	91	19	\$2408	\$2890

Two open veneer shelves and two lateral file drawers on bottom. Includes one adjustable shelf. Lock secures all drawers. Front-to-back and side-to-side filing. **Not for stacking materials on lateral file drawer bottom.**

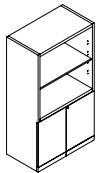

Storage Module w/Open Shelf

D22D22H48	22 x 36 x 48	150	117	23	\$1855	\$2226
D22D22W30H48	22 x 30 x 48	150	101	19	\$1269	\$1523
D22D20H48	20 x 36 x 48	150	107	23	\$1459	\$1751
D22D20W30H48	20 x 30 x 48	150	91	19	\$1213	\$1456

Two open veneer shelves and storage cabinet on bottom. Includes one adjustable shelf in upper compartment and one adjustable shelf in storage cabinet. Lock secures storage cabinet.

WARDROBE CABINETS - 48" HIGH

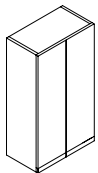

Wardrobe Cabinet

D2D22H48	22 x 36 x 48	150	107	22	\$1681	\$2018
D2D22W30H48	22 x 30 x 48	150	107	19	\$1644	\$1973
D2D22W24H48	22 x 24 x 48	150	85	15	\$1968	\$2362
D2H48	20 x 36 x 48	150	102	20	\$1528	\$1834
D2W30H48	20 x 30 x 48	150	89	17	\$1496	\$1796
D2W24H48	20 x 24 x 48	150	72	13	\$1463	\$1756

Includes full length hanging rod and fixed hat shelf.

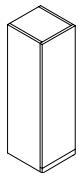

Wardrobe Cabinet - LEFT

D2D22W24H48L	22 x 24 x 48	150	80	15	\$1612	\$1935
D2D22W18H48L	22 x 18 x 48	150	60	11	\$1297	\$1557
D2D22W12H48L	22 x 12 x 48	150	40	7	\$1237	\$1485
D2D20W24H48L	20 x 24 x 48	150	72	13	\$1463	\$1756
D2D20W18H48L	20 x 18 x 48	150	54	10	\$1181	\$1418
D2D20W12H48L	20 x 12 x 48	125	36	7	\$1373	\$1648

Includes full length hanging rod and fixed hat shelf. Handle is on the **right**, door opens to the **left**.

Required Specifications

Veneer Finish (doors, drawer fronts)
Laminate Finish (top/body)
Handle Style

Optional Specifications

Lock (Wardrobe Cabinets)
Veneer Top

D DUFFERIN

WARDROBE CABINETS - 48" HIGH

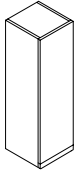

Wardrobe Cabinet - RIGHT

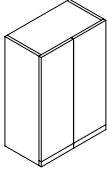

Wardrobe Cabinet/Shelving Combo

MODEL#	DIMENSIONS D x W x H	FREIGHT CLASS	WT/LBS.	CUBIC FT.	VENEER/LAMINATE	ALL VENEER
D2D22W24H48R	22 x 24 x 48	150	80	15	\$1612	\$1935
D2D22W18H48R	22 x 18 x 48	150	60	11	\$1297	\$1557
D2D22W12H48R	22 x 12 x 48	150	40	7	\$1237	\$1485
D2D20W24H48R	20 x 24 x 48	150	72	13	\$1463	\$1756
D2D20W18H48R	20 x 18 x 48	150	54	10	\$1181	\$1418
D2D20W12H48R	20 x 12 x 48	125	36	7	\$1373	\$1648

Includes full length hanging rod and fixed hat shelf. Handle is on the **left**, door opens to the **right**.

D25D22H48	22 x 36 x 48	150	117	23	\$1788	\$2146
D25D22W30H48	22 x 30 x 48	150	101	19	\$1755	\$2106
D25D20H48	20 x 36 x 48	150	107	23	\$1713	\$2056
D25D20W30H48	20 x 30 x 48	60	91	19	\$1681	\$2018

Wardrobe compartment on **left** includes hanging rod and fixed hat shelf. Storage compartment on **right** includes three adjustable shelves.

STORAGE MODULES - 54" HIGH (FREESTANDING)

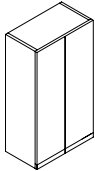

Storage Cabinet w/Doors

D1D22H54	22 x 36 x 54	150	120	22	\$1820	\$2184
D1D22W30H54	22 x 30 x 54	150	102	19	\$1811	\$2174
D1D22W24H54	22 x 24 x 54	150	81	17	\$2213	\$2656
D1D20H54	20 x 36 x 54	150	110	20	\$1718	\$2062
D1D20W30H54	20 x 30 x 54	150	92	17	\$1681	\$2018
D1D20W24H54	20 x 24 x 54	150	71	13	\$1649	\$1979

Includes four adjustable shelves.



Storage Cabinet w/Door - LEFT

D1D22W18H54L	22 x 18 x 54	150	68	12	\$1463	\$1756
D1D22W16H54L	22 x 16 x 54	150	61	11	\$1297	\$1557
D1D20W18H54L	20 x 18 x 54	125	68	11	\$1325	\$1590
D1D20W16H54L	20 x 16 x 54	125	61	10	\$1181	\$1418

Includes three adjustable shelves. Handle is on the **right**, door opens to the **left**.



Storage Cabinet w/Door - RIGHT

D1D22W18H54R	22 x 18 x 54	150	68	12	\$1463	\$1756
D1D22W16H54R	22 x 16 x 54	150	61	11	\$1297	\$1557
D1D20W18H54R	20 x 18 x 54	125	68	11	\$1325	\$1590
D1D20W16H54R	20 x 16 x 54	125	61	10	\$1181	\$1418

Includes three adjustable shelves. Handle is on the **left**, door opens to the **right**.

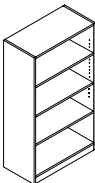

Open Storage Cabinet

D7D22W36H54	22 x 36 x 54	150	132	25	\$1825	\$2190
D7D22W30H54	22 x 30 x 54	150	110	21	\$1352	\$1623
D7D22W24H54	22 x 24 x 54	150	88	17	\$1084	\$1301
D7D22W18H54	22 x 18 x 54	150	67	12	\$848	\$1018
D7D20W36H54	20 x 36 x 54	150	122	23	\$1658	\$1990
D7D20W30H54	20 x 30 x 54	150	102	19	\$1232	\$1479
D7D20W24H54	20 x 24 x 54	150	81	15	\$982	\$1179
D7D20W18H54	20 x 18 x 54	150	61	11	\$797	\$957

One fixed and **three** adjustable veneer shelves. Shelves are ¾" thick.

Required Specifications

Veneer Finish (doors)
Laminate Finish (top/body)
Handle Style

Optional Specifications

Lock (models with doors)
Veneer Top

STORAGE MODULES - 54" HIGH (FREESTANDING)

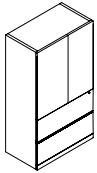

Two File Module w/Doors

MODEL#	DIMENSIONS D x W x H	FREIGHT CLASS	WT/LBS.	CUBIC FT.	VENEER/LAMINATE	ALL VENEER
D13D22H54	22 x 36 x 54	150	130	24	\$3010	\$3612
D13D22W30H54	22 x 30 x 54	150	112	20	\$2227	\$2673
D13H54	20 x 36 x 54	125	120	19	\$2362	\$2835
D13W30H54	20 x 30 x 54	150	102	21	\$2135	\$2562

Two lateral file drawers on bottom. Includes two adjustable shelves. Lower lock secures two file drawers. Front-to-back and side-to-side filing. **Not for stacking materials on lateral file drawer bottom.**

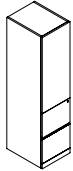

Two File Module w/Door - LEFT

D17D22H54L	22 x 16 x 54	100	110	13	\$1834	\$2201
D17D20H54L	20 x 16 x 54	125	99	13	\$1667	\$2001

Two file drawers on bottom. Includes two adjustable shelves. Lower lock secures two file drawers. Handle is on the right, door opens to the left.

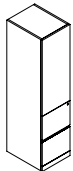

Two File Module w/Door - RIGHT

D17D22H54R	22 x 16 x 54	100	110	13	\$1834	\$2201
D17D20H54R	20 x 16 x 54	125	99	13	\$1667	\$2001

Two file drawers on bottom. Includes two adjustable shelves. Lower lock secures two file drawers. Handle is on the left, door opens to the right.

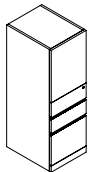

Box/Box/File Module w/Door - LEFT

D18D22H54L	22 x 16 x 54	125	71	10	\$1834	\$2201
D18D20H54L	20 x 16 x 54	125	66	10	\$1667	\$2001

Two box drawers and one file drawer on bottom. Includes two adjustable shelves. Lower lock secures all drawers. Handle is on the **right**, door opens to the **left**.

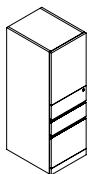

Box/Box/File Module w/Door - RIGHT

D18D22H54R	22 x 16 x 54	125	71	10	\$1834	\$2201
D18D20H54R	20 x 16 x 54	125	66	10	\$1667	\$2001

Two box drawers and one file drawer on bottom. Includes two adjustable shelves. Lower lock secures all drawers. Handle is on the **left**, door opens to the **right**.

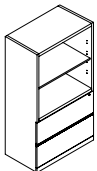

Two File Module w/Open Shelf

D12D22H54	22 x 36 x 54	150	130	24	\$2463	\$2956
D12D22W30H54	22 x 30 x 54	150	112	20	\$2000	\$2400
D12H54	20 x 36 x 54	125	120	19	\$2463	\$2956
D12W30H54	20 x 30 x 54	150	102	21	\$1917	\$2301

Two open veneer shelves and two lateral file drawers on bottom. Includes one adjustable shelf. Lock secures all drawers. Front-to-back and side-to-side filing. **Not for stacking materials on lateral file drawer bottom.**

Required Specifications

Veneer Finish (doors, drawer fronts, open shelves)
Laminate Finish (top/body)
Handle Style

Optional Specifications

Additional Lock (storage compartments)
Veneer Top

D DUFFERIN

STORAGE MODULES - 54" HIGH (FREESTANDING)

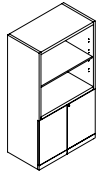

Storage Module w/Open Shelf

MODEL#	DIMENSIONS D x W x H	FREIGHT CLASS	WT/LBS.	CUBIC FT.	VENEER/LAMINATE	ALL VENEER
D22D22H54	22 x 36 x 54	150	130	24	\$1709	\$2051
D22D22W30H54	22 x 30 x 54	150	112	20	\$1426	\$1712
D22D20H54	20 x 36 x 54	150	120	24	\$1639	\$1967
D22D20W30H54	20 x 30 x 54	150	102	20	\$1366	\$1640

Two open veneer shelves and storage cabinet on bottom. Includes one adjustable shelf in upper compartment and one adjustable shelf in storage cabinet. Lock secures storage cabinet.

WARDROBE CABINETS - 54" HIGH

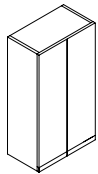

Wardrobe Cabinet

D2D22H54	22 x 36 x 54	150	120	25	\$1820	\$2184
D2D22W30H54	22 x 30 x 54	150	120	21	\$1811	\$2174
D2D22W24H54	22 x 24 x 54	150	95	17	\$2213	\$2656
D2H54	20 x 36 x 54	150	119	23	\$1718	\$2062
D2W30H54	20 x 30 x 54	150	101	19	\$1681	\$2018
D2W24H54	20 x 24 x 54	150	81	15	\$1649	\$1979

Includes full length hanging rod and fixed hat shelf.

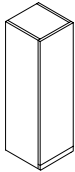

Wardrobe Cabinet - LEFT

D2D22W24H54L	22 x 24 x 54	150	90	17	\$1811	\$2174
D2D22W18H54L	22 x 18 x 54	150	68	12	\$1459	\$1751
D2D22W12H54L	22 x 12 x 54	150	45	8	\$1389	\$1667
D2D20W24H54L	20 x 24 x 54	150	81	15	\$2012	\$2415
D2D20W18H54L	20 x 18 x 54	150	61	11	\$1325	\$1590
D2D20W12H54L	20 x 12 x 54	150	41	8	\$1545	\$1854

Includes full length hanging rod and fixed hat shelf. Handle is on the **right**, door opens to the **left**.

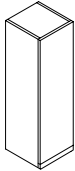

Wardrobe Cabinet - RIGHT

D2D22W24H54R	22 x 24 x 54	150	90	17	\$1811	\$2174
D2D22W18H54R	22 x 18 x 54	150	68	12	\$1459	\$1751
D2D22W12H54R	22 x 12 x 54	150	45	8	\$1389	\$1667
D2D20W24H54R	20 x 24 x 54	150	81	15	\$2012	\$2415
D2D20W18H54R	20 x 18 x 54	150	61	11	\$1325	\$1590
D2D20W12H54R	20 x 12 x 54	150	41	8	\$1545	\$1854

Includes full length hanging rod and fixed hat shelf. Handle is on the **left**, door opens to the **right**.

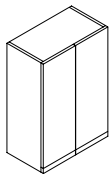

Wardrobe Cabinet/Shelving Combo

D25D22H54	22 x 36 x 54	150	130	24	\$2010	\$2412
D25D22W30H54	22 x 30 x 54	150	112	20	\$1973	\$2368
D25D20H54	20 x 36 x 54	150	120	24	\$1926	\$2312
D25D20W30H54	20 x 30 x 54	150	102	20	\$1894	\$2273

Wardrobe compartment on **left** includes hanging rod and fixed hat shelf. Storage compartment on **right** includes three adjustable shelves.

STORAGE MODULES - 66" HIGH (FREESTANDING)

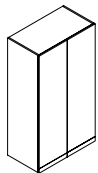

Storage Cabinet w/Doors

D1D22	22 x 36 x 66	100	259	30	\$2250	\$2700
D1D22W30	22 x 30 x 66	100	259	25	\$1970	\$2364
D1D22W24	22 x 24 x 66	125	173	22	\$1691	\$2030
D1	20 x 36 x 66	100	245	28	\$2145	\$2574
D1W30	20 x 30 x 66	100	202	23	\$1788	\$2146
D1W24	20 x 24 x 66	125	163	18	\$1427	\$1713

Includes four adjustable shelves.

Required Specifications

Veneer Finish (doors, open shelves)
Laminate Finish (top/body)
Handle Style

Optional Specifications

Lock (Wardrobe Cabinets)
Veneer Top

STORAGE MODULES - 66" HIGH (FREESTANDING)

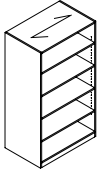

Open Storage Cabinet

MODEL#	DIMENSIONS D x W x H	FREIGHT CLASS	WT/LBS.	CUBIC FT.	veneer/LAMINATE	ALL VENEER
D7D24	24 x 36 x 66	100	281	33	\$2070	\$2484
D7D24W30	24 x 30 x 66	100	234	28	\$1811	\$2174
D7	20 x 36 x 66	100	234	28	\$1716	\$2060
D7W30	20 x 30 x 66	100	193	23	\$1505	\$1806

Includes one fixed and **four** adjustable veneer shelves. Shelves are 3/4" thick.

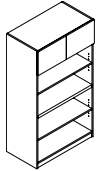

Open Storage Cabinet w/Doors

D9D22	22 x 36 x 66	92.5	308	30	\$1936	\$2324
D9D22W30	22 x 30 x 66	92.5	257	25	\$1695	\$2034
D9	20 x 36 x 66	92.5	294	28	\$1843	\$2212
D9W30	20 x 30 x 66	92.5	243	23	\$1538	\$1846

Storage compartment with fixed shelf. One fixed and **two** adjustable veneer shelves. Fixed shelf is at 29" high. Shelves are 3/4" thick.

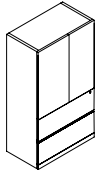

Two File Module w/Doors

D13D22	22 x 36 x 66	92.5	313	30	\$2785	\$3342
D13D22W30	22 x 30 x 66	92.5	261	25	\$2440	\$2928
D13	20 x 36 x 66	92.5	299	28	\$2653	\$3184
D13W30	20 x 30 x 66	92.5	247	23	\$2212	\$2655

Two lateral file drawers on bottom. Includes **two** adjustable shelves. Lower lock secures two file drawers. Front-to-back and side-to-side filing. **Not for stacking materials on lateral file drawer bottom.**

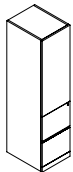

Two File Module w/Door - LEFT

D17D22L	22 x 16 x 66	125	91	13	\$1936	\$2324
D17D20L	20 x 16 x 66	125	83	12	\$1760	\$2112

Two file drawers on bottom. Includes two adjustable shelves. Lower lock secures two file drawers. Handle is on the **right**, door opens to the **left**.

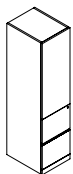

Two File Module w/Door - RIGHT

D17D22R	22 x 16 x 66	125	91	13	\$1936	\$2324
D17D20R	20 x 16 x 66	125	83	12	\$1760	\$2112

Two file drawers on bottom. Includes two adjustable shelves. Lower lock secures two file drawers. Handle is on the **left**, door opens to the **right**.

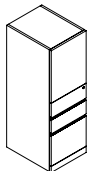

Box/Box/File Module w/Door - LEFT

D18D22L	22 x 16 x 66	125	91	13	\$1936	\$2324
D18D20L	20 x 16 x 66	125	83	12	\$1760	\$2112

Two box drawers and one file drawer on bottom. Includes two adjustable shelves. Lower lock secures all drawers. Handle is on the **right**, door opens to the **left**.

Required Specifications

Veneer Finish (doors, drawer fronts, open shelves)
Laminate Finish (top/body)
Handle Style (models with doors)

Optional Specifications

Additional Lock (storage compartments)
Veneer Top

D DUFFERIN

STORAGE MODULES - 66" HIGH (FREESTANDING)

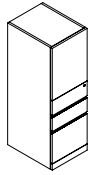

Box/Box/File Module w/Door - RIGHT

MODEL#	DIMENSIONS D x W x H	FREIGHT CLASS	WT/LBS.	CUBIC FT.	VENEER/LAMINATE	ALL VENEER
D18D22R	22 x 16 x 66	125	91	13	\$1936	\$2324
D18D20R	20 x 16 x 66	125	83	12	\$1760	\$2112

Two box drawers and one file drawer on bottom. Includes two adjustable shelves. Lower lock secures all drawers. Handle is on the left, door opens to the right.

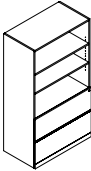

Two File Module w/Open Shelves

D12D22	22 x 36 x 66	92.5	303	30	\$2446	\$2936
D12D22W30	22 x 30 x 66	92.5	253	25	\$2141	\$2570
D12	20 x 36 x 66	92.5	289	28	\$2327	\$2793
D12W30	20 x 30 x 66	92.5	239	23	\$1942	\$2331

Three open veneer shelves and two lateral file drawers on bottom. Includes two adjustable shelves. Lock secures all drawers. Front-to-back and side-to-side filing. **Not for stacking materials on lateral file drawer bottom.**

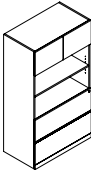

Two File Module w/Doors and Open Shelves

D10D22	22 x 36 x 66	92.5	308	30	\$2706	\$3248
D10D22W30	22 x 30 x 66	92.5	257	25	\$2369	\$2843
D10	20 x 36 x 66	92.5	294	28	\$2576	\$3092
D10W30	20 x 30 x 66	92.5	243	23	\$2148	\$2578

Storage compartment with fixed shelf. Two open veneer shelves and two lateral file drawers on bottom. Includes one adjustable shelf. Lock secures all drawers. Front-to-back and side-to-side filing. **Not for stacking materials on lateral file drawer bottom.**

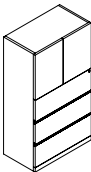

Three File Module w/Doors

D14D22	22 x 36 x 66	100	286	30	\$2996	\$3596
D14D22W30	22 x 30 x 66	100	238	25	\$2623	\$3148
D14	20 x 36 x 66	100	272	28	\$2854	\$3425
D14W30	20 x 30 x 66	100	224	23	\$2377	\$2853

Three lateral file drawers on bottom. Includes one adjustable shelf. Lock secures all drawers. Front-to-back and side-to-side filing. **Not for stacking materials on lateral file drawer bottom.**

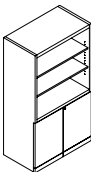

Storage Module w/Open Shelves

D22D22	22 x 36 x 66	100	275	30	\$2051	\$2462
D22D22W30	22 x 30 x 66	100	243	25	\$1795	\$2154
D22	20 x 36 x 66	100	278	28	\$1955	\$2346
D22W30	20 x 30 x 66	100	229	23	\$1627	\$1953

Three open veneer shelves and storage cabinet on bottom. Includes two adjustable shelves in upper compartment and one adjustable shelf in storage cabinet. Lock secures storage cabinet.

WARDROBE CABINETS - 66" HIGH (FREESTANDING)

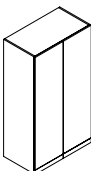

Wardrobe Cabinet

D2D22	22 x 36 x 66	100	259	30	\$1955	\$2346
D2D22W30	22 x 30 x 66	100	216	30	\$1709	\$2051
D2D22W24	22 x 24 x 66	100	198	22	\$1465	\$1758
D2	20 x 36 x 66	100	245	28	\$1861	\$2234
D2W30	20 x 30 x 66	100	202	23	\$1550	\$1860
D2W24	20 x 24 x 66	125	163	18	\$1240	\$1488

Includes full length hanging rod and fixed hat shelf.

Required Specifications

Veneer Finish (doors, drawer fronts)
Laminate Finish (top/body)
Handle Style

Optional Specifications

Additional Lock (storage compartments)
Lock (Wardrobe Cabinets)
Veneer Top

WARDROBE CABINETS - 66" HIGH (FREESTANDING) MODEL# DIMENSIONS FREIGHT CLASS WT/LBS. CUBIC FT. VENEER/LAMINATE ALL VENEER

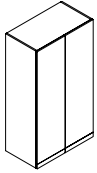

Wardrobe Cabinet/Shelving Combo

	D x W x H						
D25D22	22 x 36 x 66	100	292	30	\$2525	\$3030	
D25D22W30	22 x 30 x 66	100	243	25	\$2209	\$2651	
D25D22W24	22 x 24 x 66	100	195	22	\$1892	\$2271	
D25	20 x 36 x 66	100	278	28	\$2403	\$2884	
D25W30	20 x 30 x 66	100	229	23	\$2004	\$2405	
D25W24	20 x 24 x 66	100	185	18	\$1603	\$1924	

Wardrobe compartment on **left** includes hanging rod and fixed hat shelf. Storage compartment on **right** includes three adjustable shelves.

PERSONAL TOWERS - 66" HIGH (FREESTANDING)

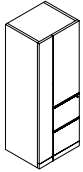

Personal Tower - LEFT

D29D22W24L	22 x 24 x 66	125	141	20	\$2630	\$3156	
D29W24L	20 x 24 x 66	125	128	18	\$2491	\$2990	

Two file drawers on bottom. Wardrobe compartment on **left** includes hanging rod. Storage compartment on **right** includes one adjustable shelf. Lower lock secures all drawers.

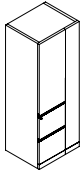

Personal Tower - RIGHT

D29D22W24R	22 x 24 x 66	125	141	20	\$2630	\$3156	
D29W24R	20 x 24 x 66	125	128	18	\$2491	\$2990	

Two file drawers on bottom. Wardrobe compartment on **right** includes hanging rod. Storage compartment on **left** includes one adjustable shelf. Lower lock secures all drawers.

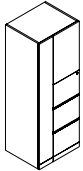

Personal Tower - LEFT

D27D22W24L	22 x 24 x 66	125	141	20	\$2991	\$3590	
D27W24L	20 x 24 x 66	125	128	18	\$2848	\$3418	

Three file drawers on bottom. Wardrobe compartment on **left** includes hanging rod. Storage compartment on **right** includes one adjustable shelf. Lower lock secures all drawers.

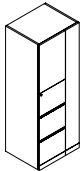

Personal Tower - RIGHT

D27D22W24R	22 x 24 x 66	125	141	20	\$2991	\$3590	
D27W24R	20 x 24 x 66	125	128	18	\$2848	\$3418	

Three file drawers on bottom. Wardrobe compartment on **right** includes hanging rod. Storage compartment on **left** includes one adjustable shelf. Lower lock secures all drawers.

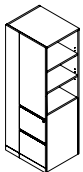

Personal Tower w/Open Bookcase - LEFT

D30D22W24L	22 x 24 x 66	125	141	20	\$2630	\$3156	
D30W24L	20 x 24 x 66	125	128	18	\$2491	\$2990	

Two file drawers on bottom. Wardrobe compartment on **left** includes hanging rod. Storage compartment on **right** includes one adjustable shelf. Open bookcase on **right** includes two adjustable shelves. Lower lock secures all drawers.

Required Specifications

Veneer Finish (doors, drawer fronts)
Laminate Finish (top/body)
Handle Style

Optional Specifications

Additional Lock (storage compartments)
Lock (Wardrobe Cabinets)
Veneer Top

D DUFFERIN

PERSONAL TOWERS - 66" HIGH (FREESTANDING)

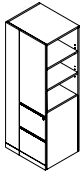

Personal Tower w/Open Bookcase - RIGHT

MODEL#	DIMENSIONS D x W x H	FREIGHT CLASS	WT/LBS.	CUBIC FT.	VENEER/LAMINATE	ALL VENEER
D30D22W24R	22 x 24 x 66	125	141	20	\$2630	\$3156
D30W24R	20 x 24 x 66	125	128	18	\$2491	\$2990

Two file drawers on bottom. Wardrobe compartment on **right** includes hanging rod. Storage compartment on **left** includes one adjustable shelf. Open bookcase on **left** includes two adjustable shelves. Lower lock secures all drawers.

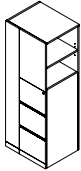

Personal Tower w/Open Bookcase - LEFT

D26D22W24L	22 x 24 x 66	125	141	20	\$3623	\$4348
D26W24L	20 x 24 x 66	125	128	18	\$3451	\$4142

Three file drawers on bottom. Wardrobe compartment on **left** includes hanging rod. Storage compartment on **right** includes one adjustable shelf. Open bookcase on **right** includes one adjustable shelf. Lower lock secures all drawers.

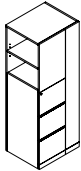

Personal Tower w/Open Bookcase - RIGHT

D26D22W24R	22 x 24 x 66	125	141	20	\$3623	\$4348
D26W24R	20 x 24 x 66	125	128	18	\$3451	\$4142

Three file drawers on bottom. Wardrobe compartment on **right** includes hanging rod. Storage compartment on **left** includes one adjustable shelf. Open bookcase on **left** includes one adjustable shelf. Lower lock secures all drawers.

STORAGE MODULES - 72" HIGH (FREESTANDING)

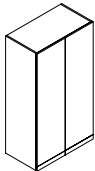

Storage Cabinet w/Doors

D1D22H72	22 x 36 x 72	100	283	33	\$2456	\$2948
D1D22W30H72	22 x 30 x 72	100	283	28	\$2148	\$2578
D1D22W24H72	22 x 24 x 72	125	255	24	\$1841	\$2210
D1H72	20 x 36 x 72	100	269	30	\$2340	\$2808
D1W30H72	20 x 30 x 72	100	233	25	\$1949	\$2339
D1W24H72	20 x 24 x 72	125	179	20	\$1560	\$1872

Includes four adjustable shelves.

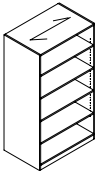

Open Storage Cabinet

D7D24H72	24 x 36 x 72	100	306	36	\$2260	\$2712
D7D24W30H72	24 x 30 x 72	100	255	30	\$1977	\$2373
D7H72	20 x 36 x 72	100	257	30	\$1873	\$2248
D7W30H72	20 x 30 x 72	100	223	25	\$1561	\$1874

Includes one fixed and **four** adjustable veneer shelves. Shelves are 3/4" thick.

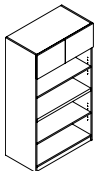

Open Storage Cabinet w/Doors

D9D22H72	22 x 36 x 72	92.5	336	33	\$2112	\$2535
D9D22W30H72	22 x 30 x 72	92.5	294	28	\$1848	\$2218
D9H72	20 x 36 x 72	92.5	322	30	\$2010	\$2412
D9W30H72	20 x 30 x 72	92.5	280	25	\$1676	\$2012

Storage compartment with fixed shelf. One fixed and **two** adjustable veneer shelves. Fixed shelf is at 29" high. Shelves are 3/4" thick.

Required Specifications

Veneer Finish (doors, drawer fronts, open shelves)
Laminate Finish (top/body)
Handle Style (models with doors)

Optional Specifications

Additional Lock (storage compartments)
Lock (Storage Cabinet with Doors)
Veneer Top

STORAGE MODULES - 72" HIGH (FREESTANDING)

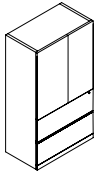

Two File Module w/Doors

MODEL#	DIMENSIONS D x W x H	FREIGHT CLASS	WT/LBS.	CUBIC FT.	VENEER/LAMINATE	ALL VENEER
D13D22H72	22 x 36 x 72	92.5	341	33	\$3041	\$3650
D13D22W30H72	22 x 30 x 72	125	299	28	\$2659	\$3191
D13H72	20 x 36 x 72	92.5	327	30	\$2895	\$3474
D13W30H72	20 x 30 x 72	92.5	285	25	\$2412	\$2895

Two lateral file drawers on bottom. Includes **two** adjustable shelves. Lower lock secures two file drawers. Front-to-back and side-to-side filing. **Not for stacking materials on lateral file drawer bottom.**

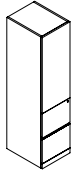

Two File Module w/Door - LEFT

D17D22H72L	22 x 16 x 72	125	99	15	\$2116	\$2540
D17D20H72L	20 x 16 x 72	125	90	13	\$1922	\$2307

Two file drawers on bottom. Includes two adjustable shelves. Lower lock secures two file drawers. Handle is on the **right**, door opens to the **left**.

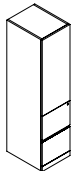

Two File Module w/Door - RIGHT

D17D22H72R	22 x 16 x 72	125	99	15	\$2116	\$2540
D17D20H72R	20 x 16 x 72	125	90	13	\$1922	\$2307

Two file drawers on bottom. Includes two adjustable shelves. Lower lock secures two file drawers. Handle is on the **left**, door opens to the **right**.

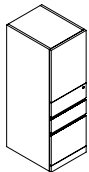

Box/Box/File Module w/Door - LEFT

D18D22H72L	22 x 16 x 72	125	99	15	\$2116	\$2540
D18D20H72L	20 x 16 x 72	125	90	13	\$1922	\$2307

Two box drawers and one file drawer on bottom. Includes two adjustable shelves. Lower lock secures all drawers. Handle is on the **right**, door opens to the **left**.

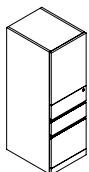

Box/Box/File Module w/Door - RIGHT

D18D22H72R	22 x 16 x 72	125	99	15	\$2116	\$2540
D18D20H72R	20 x 16 x 72	125	90	13	\$1922	\$2307

Two box drawers and one file drawer on bottom. Includes two adjustable shelves. Lower lock secures all drawers. Handle is on the **left**, door opens to the **right**.

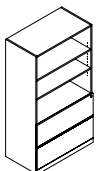

Two File Module w/Open Shelves

D12D22H72	22 x 36 x 72	92.5	331	33	\$2669	\$3203
D12D22W30H72	22 x 30 x 72	92.5	289	28	\$2334	\$2801
D12H72	20 x 36 x 72	92.5	317	30	\$2541	\$3050
D12W30H72	20 x 30 x 72	92.5	275	25	\$2223	\$2668

Three open veneer shelves and two lateral file drawers on bottom. Includes two adjustable shelves. Lock secures all drawers. Front-to-back and side-to-side filing. **Not for stacking materials on lateral file drawer bottom.**

Required Specifications

Veneer Finish (doors, drawer fronts, open shelves)
Laminate Finish (top/body)
Handle Style

Optional Specifications

Additional Lock (storage compartments)
Veneer Top

D DUFFERIN

STORAGE MODULES - 72" HIGH (FREESTANDING)

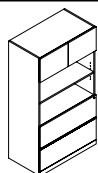

Two File Module w/Doors and Open Shelves

MODEL#	DIMENSIONS D x W x H	FREIGHT CLASS	WT/LBS.	CUBIC FT.	VENEER/LAMINATE	ALL VENEER
D10D22H72	22 x 36 x 72	92.5	336	33	\$2952	\$3543
D10D22W30H72	22 x 30 x 72	92.5	294	28	\$2583	\$3100
D10H72	20 x 36 x 72	92.5	322	30	\$2810	\$3372
D10W30H72	20 x 30 x 72	92.5	280	25	\$2342	\$2811

Storage compartment with fixed shelf. Two open veneer shelves and two lateral file drawers on bottom. Includes one adjustable shelf. Lock secures all drawers. Front-to-back and side-to-side filing. **Not for stacking materials on lateral file drawer bottom.**

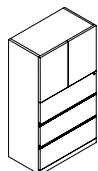

Three File Module w/Doors

D14D22H72	22 x 36 x 72	100	312	33	\$3268	\$3922
D14D22W30H72	22 x 30 x 72	100	273	28	\$2860	\$3432
D14H72	20 x 36 x 72	100	298	30	\$3112	\$3735
D14W30H72	20 x 30 x 72	92.5	259	25	\$2594	\$3113

Three lateral file drawers on bottom. Includes one adjustable shelf. Lock secures all drawers. Front-to-back and side-to-side filing. **Not for stacking materials on lateral file drawer bottom.**

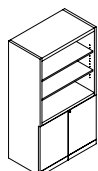

Storage Module w/Open Shelves

D22D22H72	22 x 36 x 72	100	300	33	\$2239	\$2687
D22D22W30H72	22 x 30 x 72	100	279	28	\$1960	\$2352
D22H72	20 x 36 x 72	100	305	30	\$2130	\$2556
D22W30H72	20 x 30 x 72	100	265	25	\$1776	\$2132

Three open veneer shelves and storage cabinet on bottom. Includes two adjustable shelves in upper compartment and one adjustable shelf in storage cabinet. Lock secures storage cabinet.

WARDROBE CABINETS - 72" HIGH (FREESTANDING)

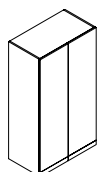

Wardrobe Cabinet

D2D22H72	22 x 36 x 72	100	283	33	\$2130	\$2556
D2D22W30H72	22 x 30 x 72	100	247	33	\$1864	\$2237
D2D22W24H72	22 x 24 x 72	125	216	24	\$1582	\$1899
D2H72	20 x 36 x 72	100	269	30	\$2030	\$2436
D2W30H72	20 x 30 x 72	100	233	25	\$1691	\$2030
D2W24H72	20 x 24 x 72	125	179	20	\$1352	\$1623

Includes full length hanging rod and fixed hat shelf.

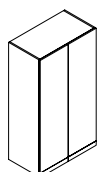

Wardrobe Cabinet/ Shelving Combo

D25D22H72	22 x 36 x 72	100	319	33	\$2755	\$3306
D25D22W30H72	22 x 30 x 72	100	279	28	\$2409	\$2891
D25D22W24H72	22 x 24 x 72	100	213	24	\$2065	\$2478
D25H72	20 x 36 x 72	92.5	305	30	\$3208	\$3850
D25W30H72	20 x 30 x 72	92.5	265	25	\$2187	\$2625
D25W24H72	20 x 24 x 72	100	203	20	\$1749	\$2099

Wardrobe compartment on **left** includes hanging rod and fixed hat shelf. Storage compartment on **right** includes three adjustable shelves.

PERSONAL TOWERS - 72" HIGH (FREESTANDING)

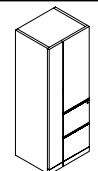

Personal Tower - LEFT

D29D22W24H72L	22 x 24 x 72	125	154	22	\$2899	\$3479
D29W24H72L	20 x 24 x 72	125	140	20	\$3355	\$4026

Two file drawers on bottom. Wardrobe compartment on **left** includes hanging rod. Storage compartment on **right** includes one adjustable shelf. Lower lock secures all drawers.

Required Specifications

Veneer Finish (doors, drawer fronts, open shelves)
Laminate Finish (top/body)
Handle Style

Optional Specifications

Additional Lock (storage compartments)
Lock (Wardrobe Cabinets)
Veneer Top

PERSONAL TOWERS - 72" HIGH (FREESTANDING)

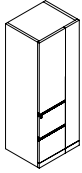

Personal Tower - RIGHT

MODEL#	DIMENSIONS D x W x H	FREIGHT CLASS	WT/LBS.	CUBIC FT.	veneer/LAMINATE	ALL VENEER
D29D22W24H72R	22 x 24 x 72	125	154	22	\$2899	\$3479
D29W24H72R	20 x 24 x 72	125	140	20	\$2746	\$3296

Two file drawers on bottom. Wardrobe compartment on **right** includes hanging rod. Storage compartment on **left** includes one adjustable shelf. Lower lock secures all drawers.

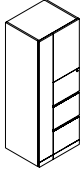

Personal Tower - LEFT

D27D22W24H72L	22 x 24 x 72	125	154	22	\$3262	\$3915
D27W24H72L	20 x 24 x 72	125	140	20	\$3108	\$3730

Three file drawers on bottom. Wardrobe compartment on **left** includes hanging rod. Storage compartment on **right** includes one adjustable shelf. Lower lock secures all drawers.

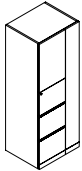

Personal Tower - RIGHT

D27D22W24H72R	22 x 24 x 72	125	154	22	\$3262	\$3915
D27W24H72R	20 x 24 x 72	125	140	20	\$3108	\$3730

Three file drawers on bottom. Wardrobe compartment on **right** includes hanging rod. Storage compartment on **left** includes one adjustable shelf. Lower lock secures all drawers.

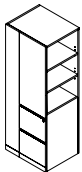

Personal Tower w/Open Bookcase - LEFT

D30D22W24H72L	22 x 24 x 72	125	154	22	\$2899	\$3479
D30W24H72L	20 x 24 x 72	125	140	20	\$2746	\$3296

Two file drawers on bottom. Wardrobe compartment on **left** includes hanging rod. Storage compartment on **right** includes one adjustable shelf. Open bookcase on **right** includes two adjustable shelves. Lower lock secures all drawers.

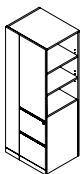

Personal Tower w/Open Bookcase - RIGHT

D30D22W24H72R	22 x 24 x 72	125	154	22	\$2899	\$3479
D30W24H72R	20 x 24 x 72	125	140	20	\$2746	\$3296

Two file drawers on bottom. Wardrobe compartment on **right** includes hanging rod. Storage compartment on **left** includes one adjustable shelf. Open bookcase on **left** includes two adjustable shelves. Lower lock secures all drawers.

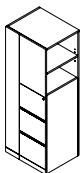

Personal Tower w/Open Bookcase - LEFT

D26D22W24H72L	22 x 24 x 72	125	154	22	\$3232	\$3879
D26W24H72L	20 x 24 x 72	125	140	20	\$3763	\$4516

Three file drawers on bottom. Wardrobe compartment on **left** includes hanging rod. Storage compartment on **right** includes one adjustable shelf. Open bookcase on **right** includes one adjustable shelf. Lower lock secures all drawers.

Required Specifications

Veneer Finish (doors, drawer fronts)
Laminate Finish (top/body)
Handle Style

Optional Specifications

Additional Lock (storage compartments)
Veneer Top

D DUFFERIN

PERSONAL TOWERS - 72" HIGH (FREESTANDING)

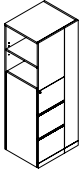

Personal Tower w/Open Bookcase - RIGHT

MODEL#	DIMENSIONS D x W x H	FREIGHT CLASS	WT/LBS.	CUBIC FT.	veneER/LAMINATE	ALL veneER
D26D22W24H72R	22 x 24 x 72	125	154	22	\$3232	\$3879
D26W24H72R	20 x 24 x 72	125	140	20	\$3763	\$4516

Three file drawers on bottom. Wardrobe compartment on **right** includes hanging rod. Storage compartment on **left** includes one adjustable shelf. Open bookcase on **left** includes one adjustable shelf. Lower lock secures all drawers.

STORAGE MODULES - 84" HIGH (FREESTANDING)

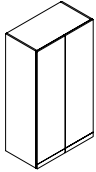

Storage Cabinet w/Doors

D1D22H84	22 x 36 x 84	125	304	42	\$2838	\$3406
D1D22W30H84	22 x 30 x 84	100	304	35	\$2482	\$2979
D1D22W24H84	22 x 24 x 84	92.5	320	28	\$2125	\$2550
D1H84	20 x 36 x 84	100	297	35	\$2704	\$3245
D1W30H84	20 x 30 x 84	100	257	29	\$2250	\$2700
D1W24H84	20 x 24 x 84	100	198	23	\$1801	\$2162

Includes four adjustable shelves. Standard with lock.

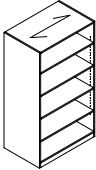

Open Storage Cabinet

D7D24H84	24 x 36 x 84	125	331	43	\$2635	\$3162
D7D24W30H84	24 x 30 x 84	125	280	36	\$2306	\$2768
D7H84	20 x 36 x 84	100	282	35	\$2301	\$2762
D7W30H84	20 x 30 x 84	100	248	29	\$1917	\$2301

Includes one fixed and **four** adjustable veneer shelves. Shelves are 3/4" thick.

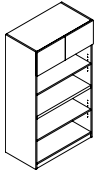

Open Storage Cabinet w/Doors

D9D22H84	22 x 36 x 84	92.5	364	36	\$2463	\$2956
D9D22W30H84	22 x 30 x 84	92.5	330	31	\$2158	\$2590
D9H84	20 x 36 x 84	92.5	348	33	\$2343	\$2812
D9W30H84	20 x 30 x 84	92.5	317	28	\$1954	\$2345

Storage compartment with fixed shelf. One fixed and **two** adjustable veneer shelves. Fixed shelf is at 29" high. Shelves are 3/4" thick.

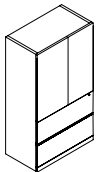

Two File Module w/Doors

D13D22H84	22 x 36 x 84	92.5	364	36	\$3514	\$4217
D13D22W30H84	22 x 30 x 84	92.5	330	31	\$3075	\$3690
D13H84	20 x 36 x 84	92.5	365	35	\$3343	\$4012
D13W30H84	20 x 30 x 84	92.5	305	29	\$3051	\$3662

Two lateral file drawers on bottom. Includes **two** adjustable shelves. Lower lock secures two file drawers. Front-to-back and side-to-side filing. **Not for stacking materials on lateral file drawer bottom.**



Two File Module w/Door - LEFT

D17D22H84L	22 x 16 x 84	125	116	17	\$2538	\$3046
D17D20H84L	20 x 16 x 84	125	105	15	\$2306	\$2768

Two file drawers on bottom. Includes two adjustable shelves. Lower lock secures two file drawers. Handle is on the **right**, door opens to the **left**.

Required Specifications

Veneer Finish (doors, drawer fronts, open shelves)
Laminate Finish (top/body)
Handle Style

Optional Specifications

Additional Lock (storage compartments)
Veneer Top

STORAGE MODULES - 84" HIGH (FREESTANDING)

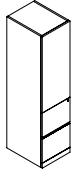

Two File Module w/Door - RIGHT

MODEL#	DIMENSIONS D x W x H	FREIGHT CLASS	WT/LBS.	CUBIC FT.	VENEER/LAMINATE	ALL VENEER
D17D22H84R	22 x 16 x 84	125	116	17	\$2538	\$3046
D17D20H84R	20 x 16 x 84	125	105	15	\$2306	\$2768

Two file drawers on bottom. Includes two adjustable shelves. Lower lock secures two file drawers. Handle is on the **left**, door opens to the **right**.

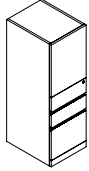

Box/Box/File Module w/Door - LEFT

D18D22H84L	22 x 16 x 84	125	116	17	\$2538	\$3046
D18D20H84L	20 x 16 x 84	125	105	15	\$2306	\$2768

Two box drawers and one file drawer on bottom. Includes two adjustable shelves. Lower lock secures all drawers. Handle is on the **right**, door opens to the **left**.

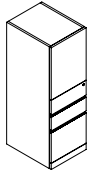

Box/Box/File Module w/Door - RIGHT

D18D22H84R	22 x 16 x 84	125	116	17	\$2538	\$3046
D18D20H84R	20 x 16 x 84	125	105	15	\$2306	\$2768

Two box drawers and one file drawer on bottom. Includes two adjustable shelves. Lower lock secures all drawers. Handle is on the **left**, door opens to the **right**.

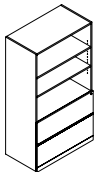

Two File Module w/Open Shelves

D12D22H84	22 x 36 x 84	92.5	364	36	\$3084	\$3701
D12D22W30H84	22 x 30 x 84	92.5	330	31	\$2700	\$3240
D12H84	20 x 36 x 84	92.5	348	33	\$2968	\$3562
D12W30H84	20 x 30 x 84	92.5	317	28	\$2570	\$3084

Three open veneer shelves and two lateral file drawers on bottom. Includes two adjustable shelves. Lock secures all drawers. Front-to-back and side-to-side filing. **Not for stacking materials on lateral file drawer bottom.**

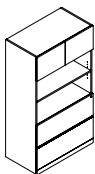

Two File Module w/Doors and Open Shelves

D10D22H84	22 x 36 x 84	92.5	364	36	\$3413	\$4096
D10D22W30H84	22 x 30 x 84	92.5	330	31	\$2987	\$3585
D10H84	20 x 36 x 84	92.5	348	33	\$3250	\$3900
D10W30H84	20 x 30 x 84	92.5	317	28	\$2709	\$3251

Storage compartment with fixed shelf. Two open veneer shelves and two lateral file drawers on bottom. Includes one adjustable shelf. Lock secures all drawers. Front-to-back and side-to-side filing. **Not for stacking materials on lateral file drawer bottom.**

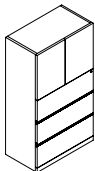

Three File Module w/Doors

D14D22H84	22 x 36 x 84	100	340	42	\$3792	\$4551
D14D22W30H84	22 x 30 x 84	100	308	35	\$3306	\$3968
D14H84	20 x 36 x 84	100	330	35	\$3598	\$4318
D14W30H84	20 x 30 x 84	92.5	298	29	\$3000	\$3600

Three lateral file drawers on bottom. Includes one adjustable shelf. Lock secures all drawers. Front-to-back and side-to-side filing. **Not for stacking materials on lateral file drawer bottom.**

Required Specifications

Veneer Finish (doors, drawer fronts, open shelves)
Laminate Finish (top/body)
Handle Style

Optional Specifications

Additional Lock (storage compartments)
Veneer Top

D DUFFERIN

STORAGE MODULES - 84" HIGH (FREESTANDING)

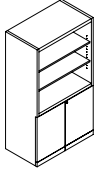

Storage Module w/Open Shelves

MODEL#	DIMENSIONS D x W x H	FREIGHT CLASS	WT/LBS.	CUBIC FT.	VENEER/LAMINATE	ALL VENEER
D22D22H84	22 x 36 x 84	125	325	42	\$2588	\$3106
D22D22W30H84	22 x 30 x 84	100	304	35	\$2264	\$2717
D22H84	20 x 36 x 84	100	327	33	\$2463	\$2956
D22W30H84	20 x 30 x 84	92.5	301	28	\$2056	\$2468

Three open veneer shelves and storage cabinet on bottom. Includes two adjustable shelves in upper compartment and one adjustable shelf in storage cabinet. Lock secures storage cabinet.

WARDROBE CABINETS - 84" HIGH (FREESTANDING)

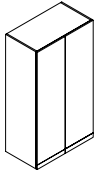

Wardrobe Cabinet

D2D22H84	22 x 36 x 84	125	307	42	\$2463	\$2956
D2D22W30H84	22 x 30 x 84	125	260	42	\$2158	\$2590
D2D22W24H84	22 x 24 x 84	100	242	28	\$1848	\$2218
D2H84	20 x 36 x 84	100	297	35	\$2343	\$2812
D2W30H84	20 x 30 x 84	100	257	29	\$1954	\$2345
D2W24H84	20 x 24 x 84	100	198	23	\$1565	\$1878

Includes full length hanging rod and fixed hat shelf.

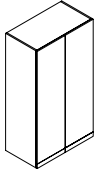

Wardrobe Cabinet/Shelving Combo

D25D22H84	22 x 36 x 84	100	348	42	\$3186	\$3824
D25D22W30H84	22 x 30 x 84	100	307	35	\$2783	\$3340
D25D22W24H84	22 x 24 x 84	100	254	28	\$2385	\$2862
D25H84	20 x 36 x 84	100	330	35	\$3033	\$3640
D25W30H84	20 x 30 x 84	92.5	300	29	\$2528	\$3034
D25W24H84	20 x 24 x 84	92.5	235	23	\$2024	\$2429

Wardrobe compartment on **left** includes hanging rod and fixed hat shelf. Storage compartment on **right** includes three adjustable shelves.

PERSONAL TOWERS - 84" HIGH (FREESTANDING)

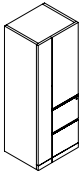

Personal Tower - LEFT

D29D22W24H84L	22 x 24 x 84	125	167	24	\$3440	\$4128
D29W24H84L	20 x 24 x 84	125	152	22	\$3260	\$3912

Two file drawers on bottom. Wardrobe compartment on **left** includes hanging rod. Storage compartment on **right** includes one adjustable shelf. Lower lock secures all drawers.

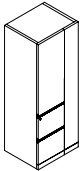

Personal Tower - RIGHT

D29D22W24H84R	22 x 24 x 84	125	167	24	\$3440	\$4128
D29W24H84R	20 x 24 x 84	125	152	22	\$3260	\$3912

Two file drawers on bottom. Wardrobe compartment on **right** includes hanging rod. Storage compartment on **left** includes one adjustable shelf. Lower lock secures all drawers.

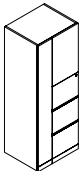

Personal Tower - LEFT

D27D22W24H84L	22 x 24 x 84	125	167	24	\$4611	\$5534
D27W24H84L	20 x 24 x 84	125	152	22	\$4390	\$5268

Three file drawers on bottom. Wardrobe compartment on **left** includes hanging rod. Storage compartment on **right** includes one adjustable shelf. Lower lock secures all drawers.

Required Specifications

Veneer Finish (doors, drawer fronts, open shelves)
Laminate Finish (top/body)
Handle Style

Optional Specifications

Additional Lock (storage compartments)
Lock (Wardrobe Cabinets)
Veneer Top

PERSONAL TOWERS - 84" HIGH (FREESTANDING)

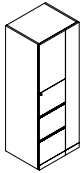

Personal Tower - RIGHT

MODEL#	DIMENSIONS D x W x H	FREIGHT CLASS	WT/LBS.	CUBIC FT.	veneer/LAMINATE	ALL VENEER
D27D22W24H84R	22 x 24 x 84	125	167	24	\$4611	\$5534
D27W24H84R	20 x 24 x 84	125	152	22	\$4390	\$5268

Three file drawers on bottom. Wardrobe compartment on **right** includes hanging rod. Storage compartment on **left** includes one adjustable shelf. Lower lock secures all drawers.

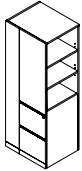

Personal Tower w/Open Bookcase - LEFT

D30D22W24H84L	22 x 24 x 84	125	167	24	\$3440	\$4128
D30W24H84L	20 x 24 x 84	125	152	22	\$3260	\$3912

Two file drawers on bottom. Wardrobe compartment on **left** includes hanging rod. Storage compartment on **right** includes one adjustable shelf. Open bookcase on **right** includes two adjustable shelves. Lower lock secures all drawers.

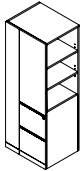

Personal Tower w/Open Bookcase - RIGHT

D30D22W24H84R	22 x 24 x 84	125	167	24	\$3440	\$4128
D30W24H84R	20 x 24 x 84	125	152	22	\$3260	\$3912

Two file drawers on bottom. Wardrobe compartment on **right** includes hanging rod. Storage compartment on **left** includes one adjustable shelf. Open bookcase on **left** includes two adjustable shelves. Lower lock secures all drawers.

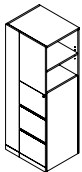

Personal Tower w/Open Bookcase - LEFT

D26D22W24H84L	22 x 24 x 84	125	167	24	\$4611	\$5534
D26W24H84L	20 x 24 x 84	125	152	22	\$4390	\$5268

Three file drawers on bottom. Wardrobe compartment on **left** includes hanging rod. Storage compartment on **right** includes one adjustable shelf. Open bookcase on **right** includes one adjustable shelf. Lower lock secures all drawers.

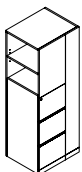

Personal Tower w/Open Bookcase - RIGHT

D26D22W24H84R	22 x 24 x 84	125	167	24	\$4611	\$5534
D26W24H84R	20 x 24 x 84	125	152	22	\$4390	\$5268

Three file drawers on bottom. Wardrobe compartment on **right** includes hanging rod. Storage compartment on **left** includes one adjustable shelf. Open bookcase on **left** includes one adjustable shelf. Lower lock secures all drawers.

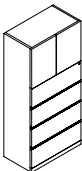

Four File Module w/Doors

D6W30H84	20 x 30 x 84	85	351	29	\$3655	\$4386
----------	--------------	----	-----	----	--------	--------

Four lateral file drawers on bottom. Includes one adjustable shelf. Lock secures all drawers. Front-to-back and side-to-side filing. **Not for stacking materials on lateral file drawer bottom.**

Required Specifications

Veneer Finish (doors, drawer fronts, open shelves)
Laminate Finish (top/body)
Handle Style

Optional Specifications

Additional Lock (storage compartments)
Veneer Top

TOPS FOR STORAGE MODELS

MODEL#	DIMENSIONS	FREIGHT CLASS	WT/LBS.	CUBIC FT.	VENEER/LAMINATE	ALL VENEER
	D x W x H					
D12024T	24 x 120 x 1	60	115	2	N/A	\$1556
D11824T	24 x 118 x 1	60	109	2	N/A	\$1533
D11624T	24 x 116 x 1	60	107	2	N/A	\$1510
D11424T	24 x 114 x 1	60	105	2	N/A	\$1491
D11224T	24 x 112 x 1	60	103	2	N/A	\$1454
D11024T	24 x 110 x 1	60	102	2	N/A	\$1426
D10824T	24 x 108 x 1	60	100	2	N/A	\$1399
D10624T	24 x 106 x 1	60	98	2	N/A	\$1375
D10424T	24 x 104 x 1	60	96	2	N/A	\$1348
D10224T	24 x 102 x 1	60	94	2	N/A	\$1325
D10024T	24 x 100 x 1	60	92	2	N/A	\$1297
D9824T	24 x 98 x 1	60	90	2	N/A	\$1269
D9624T	24 x 96 x 1	60	88	2	N/A	\$1246
D9424T	24 x 94 x 1	60	86	2	N/A	\$1218
D9224T	24 x 92 x 1	60	85	2	N/A	\$1195
D9024T	24 x 90 x 1	60	83	2	N/A	\$1167
D8824T	24 x 88 x 1	60	81	2	N/A	\$1144
D8624T	24 x 86 x 1	60	80	2	N/A	\$1116
D8424T	24 x 84 x 1	60	78	2	N/A	\$1088
D8224T	24 x 82 x 1	60	75	2	N/A	\$1065
D8024T	24 x 80 x 1	60	74	2	N/A	\$1038
D7824T	24 x 78 x 1	60	72	2	N/A	\$1024
D7624T	24 x 76 x 1	60	70	2	N/A	\$987
D7424T	24 x 74 x 1	60	69	2	N/A	\$963
D7224T	24 x 72 x 1	60	66	2	N/A	\$936
D7024T	24 x 70 x 1	60	64	2	N/A	\$908
D6824T	24 x 68 x 1	60	62	2	N/A	\$885
D6624T	24 x 66 x 1	60	61	2	N/A	\$857
D6424T	24 x 64 x 1	60	59	1	N/A	\$829
D6224T	24 x 62 x 1	60	57	1	N/A	\$806
D6024T	24 x 60 x 1	60	55	1	N/A	\$778
D5824T	24 x 58 x 1	60	54	1	N/A	\$750
D5624T	24 x 56 x 1	60	52	1	N/A	\$727
D5424T	24 x 54 x 1	60	50	1	N/A	\$700
D5224T	24 x 52 x 1	60	48	1	N/A	\$676
D5024T	24 x 50 x 1	60	46	1	N/A	\$649
D4824T	24 x 48 x 1	60	44	1	N/A	\$621
D4224T	24 x 42 x 1	60	39	1	N/A	\$602
D4024T	24 x 40 x 1	60	37	1	N/A	\$575
D3824T	24 x 38 x 1	60	35	1	N/A	\$547
D3624T	24 x 36 x 1	60	33	1	N/A	\$514
D3424T	24 x 34 x 1	60	31	1	N/A	\$482
D3224T	24 x 32 x 1	65	29	1	N/A	\$454
D3024T	24 x 30 x 1	65	28	1	N/A	\$389
D2424T	24 x 24 x 1	65	23	1	N/A	\$389
D1824T	24 x 18 x 1	70	17	1	N/A	\$283
D1624T	24 x 16 x 1	70	15	1	N/A	\$274
D1224T	24 x 12 x 1	92.5	11	1	N/A	\$204

EXAMPLE:

(1) D9024T

Veneer Top

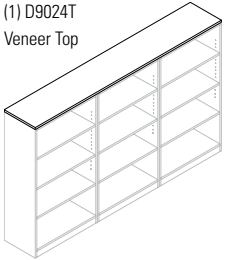

(3) D7D22W30H48 - Open Storage Cabinet

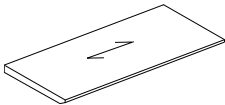

Tops - 24" Deep

For use with 22" deep units. Tops are 1" thick.

- **This is an OPTION for Storage Modules, Wardrobe Cabinets and Personal Towers.**
Specify a Veneer Top from the listing above (either a single model or straight run).

Required Specifications

Veneer Finish

TOPS FOR STORAGE MODELS

MODEL#	DIMENSIONS	FREIGHT CLASS	WT/LBS.	CUBIC FT.	VENEER/LAMINATE	ALL VENEER
D x W x H						
D12022T	22 x 120 x 1	60	101	2	N/A	\$1426
D11822T	22 x 118 x 1	60	100	2	N/A	\$1403
D11622T	22 x 116 x 1	60	97	2	N/A	\$1380
D11422T	22 x 114 x 1	60	96	2	N/A	\$1357
D11222T	22 x 112 x 1	60	95	2	N/A	\$1334
D11022T	22 x 110 x 1	60	92	2	N/A	\$1306
D10822T	22 x 108 x 1	60	91	2	N/A	\$1283
D10622T	22 x 106 x 1	60	89	2	N/A	\$1260
D10422T	22 x 104 x 1	60	87	2	N/A	\$1237
D10222T	22 x 102 x 1	60	86	2	N/A	\$1213
D10022T	22 x 100 x 1	60	84	2	N/A	\$1190
D9822T	22 x 98 x 1	60	83	2	N/A	\$1163
D9622T	22 x 96 x 1	60	81	2	N/A	\$1139
D9422T	22 x 94 x 1	60	79	2	N/A	\$1116
D9222T	22 x 92 x 1	60	77	2	N/A	\$1093
D9022T	22 x 90 x 1	60	76	2	N/A	\$1093
D8822T	22 x 88 x 1	60	74	2	N/A	\$1047
D8622T	22 x 86 x 1	60	73	2	N/A	\$1024
D8422T	22 x 84 x 1	60	71	2	N/A	\$1000
D8222T	22 x 82 x 1	60	69	2	N/A	\$977
D8022T	22 x 80 x 1	60	67	2	N/A	\$950
D7822T	22 x 78 x 1	60	66	2	N/A	\$926
D7622T	22 x 76 x 1	60	65	2	N/A	\$903
D7422T	22 x 74 x 1	60	63	2	N/A	\$880
D7222T	22 x 72 x 1	60	61	2	N/A	\$880
D7022T	22 x 70 x 1	65	59	2	N/A	\$834
D6822T	22 x 68 x 1	65	57	2	N/A	\$811
D6622T	22 x 66 x 1	65	55	2	N/A	\$788
D6422T	22 x 64 x 1	65	54	1	N/A	\$760
D6222T	22 x 62 x 1	60	52	1	N/A	\$737
D6022T	22 x 60 x 1	60	50	1	N/A	\$713
D5822T	22 x 58 x 1	60	49	1	N/A	\$690
D5622T	22 x 56 x 1	60	47	1	N/A	\$667
D5422T	22 x 54 x 1	60	46	1	N/A	\$644
D5222T	22 x 52 x 1	60	44	1	N/A	\$621
D5022T	22 x 50 x 1	60	42	1	N/A	\$593
D4822T	22 x 48 x 1	60	40	1	N/A	\$570
D4222T	22 x 42 x 1	60	36	1	N/A	\$551
D4022T	22 x 40 x 1	60	34	1	N/A	\$524
D3822T	22 x 38 x 1	60	32	1	N/A	\$500
D3622T	22 x 36 x 1	60	30	1	N/A	\$473
D3422T	22 x 34 x 1	65	28	1	N/A	\$445
D3222T	22 x 32 x 1	65	27	1	N/A	\$417
D3022T	22 x 30 x 1	65	25	1	N/A	\$389
D2422T	22 x 24 x 1	70	20	1	N/A	\$375
D1822T	22 x 18 x 1	70	15	1	N/A	\$283
D1622T	22 x 16 x 1	85	14	1	N/A	\$250
D1222T	22 x 12 x 1	92.5	10	1	N/A	\$186

EXAMPLE:

(1) D9022T
Veneer Top

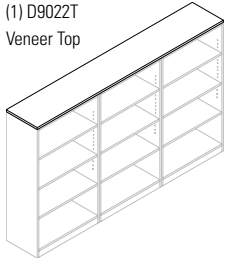

(3) D7D20W30H48 - Open Storage Cabinet

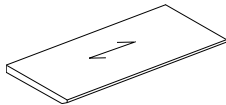

Tops - 22" Deep

For use with 20" deep units. Tops are 1" thick.

• **This is an OPTION for Storage Modules, Wardrobe Cabinets and Personal Towers.**
Specify a Veneer Top from the listing above (either a single model or straight run).

Required Specifications

Veneer Finish

OVERHEAD STORAGE

sizes 48" and larger

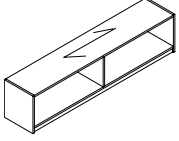

sizes less than 48"

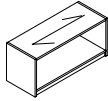

Open Front Overhead Storage

MODEL#	DIMENSIONS D x W x H	FREIGHT CLASS	WT/LBS.	CUBIC FT.	VENEER/LAMINATE	ALL VENEER
DCSF072	14.5 x 72 x 16.5	125	100	10	\$1100	\$1320
DCSF066	14.5 x 66 x 16.5	125	83	9	\$1009	\$1211
DCSF060	14.5 x 60 x 16.5	100	75	8	\$916	\$1100
DCSF054	14.5 x 54 x 16.5	100	68	7	\$825	\$990
DCSF048	14.5 x 48 x 16.5	100	60	7	\$734	\$881
DCSF042	14.5 x 42 x 16.5	100	55	6	\$678	\$814
DCSF036	14.5 x 36 x 16.5	100	50	5	\$670	\$804
DCSF030	14.5 x 30 x 16.5	100	45	4	\$656	\$788

Includes pre-mounted "J" brackets for wall mount applications.

- NOTE:** Care should be taken to mount the units. Units should be mounted to wall studs using correct fasteners. Failure to do so may result in collapse of the unit and subsequent personal injury. **Mounting hardware not included.** Mounting hardware used should be based on wall material. Consult an installation professional for proper wall mounting.

sizes 48" and larger

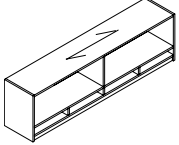

sizes less than 48"

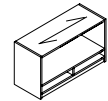

Open Front Overhead Storage - Pigeon-Hole Storage

DCSFOP72	14.5 x 72 x 19.5	125	100	12	\$1320	\$1584
DCSFOP66	14.5 x 66 x 19.5	125	83	11	\$1210	\$1452
DCSFOP60	14.5 x 60 x 19.5	125	75	10	\$1100	\$1320
DCSFOP54	14.5 x 54 x 19.5	125	68	9	\$992	\$1191
DCSFOP48	14.5 x 48 x 19.5	125	60	8	\$879	\$1055
DCSFOP42	14.5 x 42 x 19.5	125	55	7	\$825	\$990
DCSFOP36	14.5 x 36 x 19.5	125	50	6	\$800	\$960
DCSFOP30	14.5 x 30 x 19.5	125	45	5	\$789	\$947

Includes pre-mounted "J" brackets for wall mount applications. Horizontal pigeon-hole storage on bottom of overhead.

- NOTE:** Care should be taken to mount the units. Units should be mounted to wall studs using correct fasteners. Failure to do so may result in collapse of the unit and subsequent personal injury. **Mounting hardware not included.** Mounting hardware used should be based on wall material. Consult an installation professional for proper wall mounting.

sizes 48" and larger

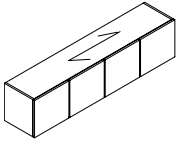

sizes less than 48"

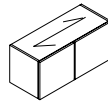

Closed Front Overhead Storage with Hinge Doors

DSF72	14.5 x 72 x 16.5	92.5	100	10	\$1422	\$1707
DSF66	14.5 x 66 x 16.5	100	83	9	\$1306	\$1568
DSF60	14.5 x 60 x 16.5	100	75	8	\$1186	\$1424
DSF54	14.5 x 54 x 16.5	100	68	7	\$1065	\$1278
DSF48	14.5 x 48 x 16.5	60	60	7	\$1047	\$1257
DSF42	14.5 x 42 x 16.5	100	55	6	\$871	\$1046
DSF36	14.5 x 36 x 16.5	92.5	50	5	\$852	\$1023
DSF30	14.5 x 30 x 16.5	92.5	45	4	\$838	\$1006

Includes pre-mounted "J" brackets for wall mount applications.

- NOTE:** Care should be taken to mount the units. Units should be mounted to wall studs using correct fasteners. Failure to do so may result in collapse of the unit and subsequent personal injury. **Mounting hardware not included.** Mounting hardware used should be based on wall material. Consult an installation professional for proper wall mounting.

sizes 48" and larger

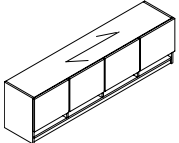

sizes less than 48"

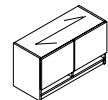

Closed Front Overhead Storage with Hinge Doors & Pigeon-Hole Storage

DSFP72	14.5 x 72 x 19.5	100	100	12	\$1709	\$2051
DSFP66	14.5 x 66 x 19.5	125	83	11	\$1565	\$1878
DSFP60	14.5 x 60 x 19.5	125	75	10	\$1426	\$1712
DSFP54	14.5 x 54 x 19.5	125	68	9	\$1283	\$1540
DSFP48	14.5 x 48 x 19.5	125	60	8	\$1135	\$1362
DSFP42	14.5 x 42 x 19.5	125	55	7	\$1084	\$1301
DSFP36	14.5 x 36 x 19.5	100	50	6	\$1024	\$1229
DSFP30	14.5 x 30 x 19.5	100	45	5	\$1010	\$1212

Includes pre-mounted "J" brackets for wall mount applications. Horizontal pigeon-hole storage on bottom of overhead.

- NOTE:** Care should be taken to mount the units. Units should be mounted to wall studs using correct fasteners. Failure to do so may result in collapse of the unit and subsequent personal injury. **Mounting hardware not included.** Mounting hardware used should be based on wall material. Consult an installation professional for proper wall mounting.

Required Specifications

Veneer Finish
Laminate Finish (top/body)

Optional Specifications

Lock (models with doors)
Handle Style (models with doors)

Accessories

Tackboard

OVERHEAD STORAGE

sizes 48" and larger

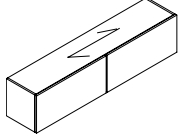

sizes less than 48"

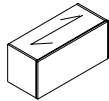

Closed Front Overhead Storage - with Flipper Doors

sizes 48" and larger

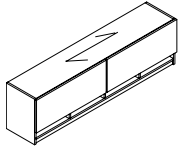

sizes less than 48"

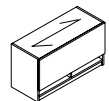

Closed Front Overhead Storage with Flipper Doors & Pigeon-Hole Storage

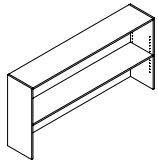

Open Hutch with Closed Back

MODEL#	DIMENSIONS D x W x H	FREIGHT CLASS	WT/LBS.	CUBIC FT.	veneER/LAMINATE	ALL veneER
DSFF72	14.5 x 72 x 16.5	92.5	100	10	\$1542	\$1851
DSFF66	14.5 x 66 x 16.5	100	83	9	\$1413	\$1696
DSFF60	14.5 x 60 x 16.5	100	75	8	\$1283	\$1540
DSFF54	14.5 x 54 x 16.5	100	68	7	\$1158	\$1390
DSFF48	14.5 x 48 x 16.5	100	60	7	\$1028	\$1234
DSFF42	14.5 x 42 x 16.5	100	55	6	\$954	\$1145
DSFF36	14.5 x 36 x 16.5	92.5	50	5	\$936	\$1124
DSFF30	14.5 x 30 x 16.5	92.5	45	4	\$922	\$1107

Includes pre-mounted "J" brackets for wall mount applications. Horizontal pigeon-hole storage on bottom of overhead.

- **NOTE:** Care should be taken to mount the units. Units should be mounted to wall studs using correct fasteners. Failure to do so may result in collapse of the unit and subsequent personal injury. **Mounting hardware not included.** Mounting hardware used should be based on wall material. Consult an installation professional for proper wall mounting.

DSFFP72	14.5 x 72 x 19.5	100	100	12	\$2023	\$2428
DSFFP66	14.5 x 66 x 19.5	125	83	11	\$1695	\$2034
DSFFP60	14.5 x 60 x 19.5	125	75	10	\$1542	\$1851
DSFFP54	14.5 x 54 x 19.5	125	68	9	\$1385	\$1662
DSFFP48	14.5 x 48 x 19.5	125	60	8	\$1232	\$1479
DSFFP42	14.5 x 42 x 19.5	125	55	7	\$1144	\$1373
DSFFP36	14.5 x 36 x 19.5	100	50	6	\$1121	\$1346
DSFFP30	14.5 x 30 x 19.5	100	45	5	\$1102	\$1323

Includes pre-mounted "J" brackets for wall mount applications. Horizontal pigeon-hole storage on bottom of overhead.

- **NOTE:** Care should be taken to mount the units. Units should be mounted to wall studs using correct fasteners. Failure to do so may result in collapse of the unit and subsequent personal injury. **Mounting hardware not included.** Mounting hardware used should be based on wall material. Consult an installation professional for proper wall mounting.

D72CL36	16 x 72 x 36	125	155	23	\$1227	\$1473
D66CL36	16 x 66 x 36	125	140	21	\$1137	\$1365
D60CL36	16 x 60 x 36	125	130	19	\$1010	\$1212
D48CL36	16 x 48 x 36	125	110	15	\$961	\$1154
D42CL36	16 x 42 x 36	125	95	13	\$871	\$1046
D36CL36	16 x 36 x 36	125	80	11	\$818	\$982
D30CL36	16 x 30 x 36	125	67	9	\$681	\$818

One adjustable shelf. Closed back. All hutches shipped pre-assembled.

- **A Tackboard cannot be used with this hutch.**

CLOSED HUTCHES

sizes 120"-108"w

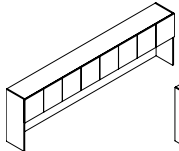

sizes 102"-84"w

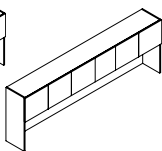

sizes 78"-60"w

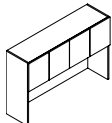

sizes 36"-30"w

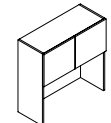

Closed Hutch w/Veneer Doors 36" High

D120SH36	16 x 120 x 36	125	295	38	\$3321	\$3986
D114SH36	16 x 114 x 36	125	281	36	\$3154	\$3785
D108SH36	16 x 108 x 36	125	268	34	\$2988	\$3586
D102SH36	16 x 102 x 36	125	254	32	\$2823	\$3388
D96SH36	16 x 96 x 36	100	241	30	\$2657	\$3189
D90SH36	16 x 90 x 36	100	227	28	\$2490	\$2988
D84SH36	16 x 84 x 36	100	214	26	\$2324	\$2789
D78SH36	16 x 78 x 36	100	200	24	\$2158	\$2590
D72SH36	16 x 72 x 36	125	187	23	\$1993	\$2392
D66SH36	16 x 66 x 36	100	173	21	\$1918	\$2302
D60SH36	16 x 60 x 36	100	160	19	\$1826	\$2192
D36SH36	16 x 36 x 36	100	94	11	\$1247	\$1497
D30SH36	16 x 30 x 36	100	78	9	\$1090	\$1308

One fixed shelf. Closed back features one grommet. All hutches shipped pre-assembled.

- Models 120"w- 108"w have three fixed shelf dividers.
- Models 84"w- 102"w have two fixed shelf dividers.
- Models 60"w - 78"w have one fixed shelf divider.
- *Clearance from worksurface to valance is 19.5".*

Required Specifications

Veneer Finish
Laminate Finish (top/body)

Optional Specifications

Lock (models with doors)
Handle Style (models with doors)

Accessories

Tackboard (not available on Open Hutch)
Tasklight (Closed Hutch)

CLOSED HUTCHES

sizes 120"-108"w

sizes 102"-84"w

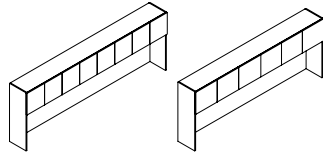

sizes 78"-60"w

sizes 30"-36"w

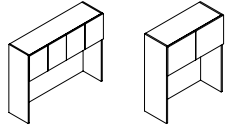

Closed Hutch w/Veneer Doors 42" H

MODEL#	DIMENSIONS D x W x H	FREIGHT CLASS	WT/LBS.	CUBIC FT.	VENEER/LAMINATE	ALL VENEER
D120SH42	16 x 120 x 42	125	341	44	\$3874	\$4649
D114SH42	16 x 114 x 42	125	324	42	\$3679	\$4415
D108SH42	16 x 108 x 42	125	307	39	\$3663	\$4396
D102SH42	16 x 102 x 42	125	290	37	\$3292	\$3951
D96SH42	16 x 96 x 42	125	273	35	\$3099	\$3719
D90SH42	16 x 90 x 42	125	256	33	\$2905	\$3486
D84SH42	16 x 84 x 42	125	239	31	\$2848	\$3418
D78SH42	16 x 78 x 42	125	222	38	\$2518	\$3022
D72SH42	16 x 72 x 42	125	205	26	\$2324	\$2789
D66SH42	16 x 66 x 42	125	188	24	\$2238	\$2686
D60SH42	16 x 60 x 42	125	171	22	\$2130	\$2556
D36SH42	16 x 36 x 42	125	102	13	\$1453	\$1744
D30SH42	16 x 30 x 42	125	85	11	\$1272	\$1527

One fixed shelf. Closed back features one grommet. All hutches shipped pre-assembled.

- Models 120"w- 108"w have three fixed shelf dividers.
- Models 84"w- 102"w have two fixed shelf dividers.
- Models 60"w - 78"w have one fixed shelf divider.
- Clearance from worksurface to valance is 19.5".

sizes 96"-84"w

sizes 78"-60"w

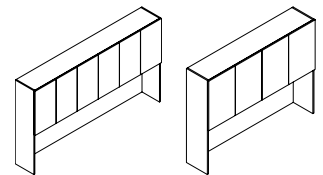

Closed Hutch w/Veneer Doors 54" H

D962SH54	15 x 96 x 54	125	351	45	\$3982	\$4779
D902SH54	15 x 90 x 54	125	329	42	\$3735	\$4482
D842SH54	15 x 84 x 54	125	307	39	\$3485	\$4182
D782SH54	15 x 78 x 54	125	285	37	\$3236	\$3884
D722SH54	15 x 72 x 54	300	263	34	\$2987	\$3585
D662SH54	15 x 66 x 54	125	241	31	\$2877	\$3453
D602SH54	15 x 60 x 54	125	219	28	\$2739	\$3287

One fixed shelf and one adjustable shelf (per compartment). Closed back features one grommet. All hutches shipped pre-assembled.

- Clearance from worksurface to valance is 25.5".

sizes 120"-108"w

sizes 102"-84"w

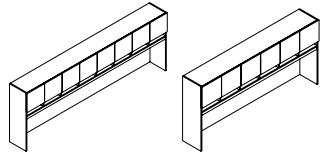

sizes 78"-60"w

sizes 30"-36"w

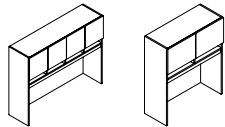

Closed Hutch w/Veneer Doors Pigeon-Hole Storage, 42" High

D120SHP42	15 x 120 x 42	125	341	44	\$4649	\$5579
D114SHP42	15 x 114 x 42	125	324	42	\$4416	\$5300
D108SHP42	15 x 108 x 42	125	307	39	\$4184	\$5021
D102SHP42	15 x 102 x 42	125	290	37	\$3951	\$4742
D96SHP42	15 x 96 x 42	125	273	35	\$3719	\$4463
D90SHP42	15 x 90 x 42	125	256	33	\$3486	\$4184
D84SHP42	15 x 84 x 42	125	239	31	\$3254	\$3905
D78SHP42	15 x 78 x 42	125	222	38	\$3021	\$3626
D72SHP42	15 x 72 x 42	125	205	26	\$2920	\$3504
D66SHP42	15 x 66 x 42	125	188	24	\$2820	\$3384
D60SHP42	15 x 60 x 42	125	171	22	\$2686	\$3224
D36SHP42	15 x 36 x 42	125	102	13	\$1744	\$2093
D30SHP42	15 x 30 x 42	125	85	11	\$1527	\$1833

One fixed shelf. Closed back features one grommet. Horizontal pigeon-hole storage top mounted to hutch. All hutches shipped pre-assembled.

- Models 120"w- 108"w have three fixed shelf dividers.
- Models 84"w- 102"w have two fixed shelf dividers.
- Models 60"w - 78"w have one fixed shelf divider.
- Clearance from worksurface to valance is 21.5".

Required Specifications

Veneer Finish (doors)
Laminate Finish (top/body)

Optional Specifications

Lock
Handle Style

Accessories

Tackboard
Tasklight

CLOSED HUTCHES

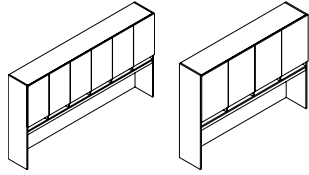

**Closed Hutch w/Veneer Doors
Pigeon-Hole Storage, 54" High**

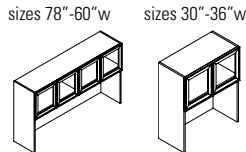
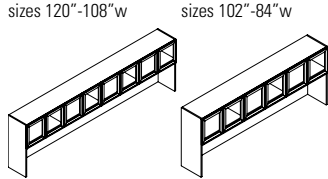

Closed Hutch w/Glass Doors 36" High

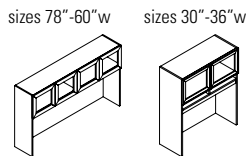
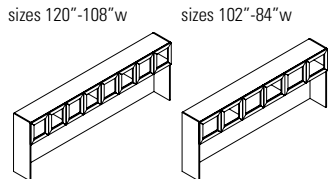

Closed Hutch w/Glass Doors 42" High

MODEL#	DIMENSIONS D x W x H	FREIGHT CLASS	WT/LBS.	CUBIC FT.	VENEER/LAMINATE	ALL VENEER
D962SHP54	15 x 96 x 54	125	351	45	\$4781	\$5738
D902SHP54	15 x 90 x 54	125	329	42	\$4480	\$5376
D842SHP54	15 x 84 x 54	125	307	39	\$4180	\$5016
D782SHP54	15 x 78 x 54	125	285	37	\$3883	\$4660
D722SHP54	15 x 72 x 54	125	263	34	\$3585	\$4302
D662SHP54	15 x 66 x 54	125	241	31	\$3451	\$4142
D602SHP54	15 x 60 x 54	125	219	28	\$3286	\$3944

One fixed shelf and one adjustable shelf (per compartment). Closed back features one grommet. Horizontal pigeon-hole storage top mounted to hutch. All hutches shipped pre-assembled.

- Clearance from worksurface to valance is 21.5".

D120SH36G	15 x 120 x 36	125	295	38	\$4968
D114SH36G	15 x 114 x 36	125	281	36	\$4769
D108SH36G	15 x 108 x 36	125	268	34	\$4575
D102SH36G	15 x 102 x 36	125	254	32	\$4107
D96SH36G	15 x 96 x 36	85	241	30	\$3917
D90SH36G	15 x 90 x 36	100	227	28	\$3723
D84SH36G	15 x 84 x 36	100	214	26	\$3533
D78SH36G	15 x 78 x 36	85	200	24	\$3348
D72SH36G	15 x 72 x 36	100	187	23	\$2908
D66SH36G	15 x 66 x 36	100	173	21	\$2783
D60SH36G	15 x 60 x 36	100	160	19	\$2658
D36SH36G	15 x 36 x 36	100	94	11	\$1690
D30SH36G	15 x 30 x 36	100	78	9	\$1510

One fixed shelf. Closed back features one grommet. Aluminum frame available in Tungsten finish only. All hutches shipped pre-assembled. Translucent, screened glass.

- Models 120" w- 108" w have three fixed shelf dividers.
- Models 84" w- 102" w have two fixed shelf dividers.
- Models 60" w - 78" w have one fixed shelf divider.
- Clearance from worksurface to valance is 19.5".
- Locks are not available on hutches with Glass Doors.

D120SH42G	15 x 120 x 42	125	341	44	\$5223
D114SH42G	15 x 114 x 42	125	324	42	\$5010
D108SH42G	15 x 108 x 42	125	307	39	\$4801
D102SH42G	15 x 102 x 42	125	290	37	\$4329
D96SH42G	15 x 96 x 42	125	273	35	\$4125
D90SH42G	15 x 90 x 42	125	256	33	\$3972
D84SH42G	15 x 84 x 42	125	239	31	\$3709
D78SH42G	15 x 78 x 42	150	222	38	\$3505
D72SH42G	15 x 72 x 42	125	205	26	\$3024
D66SH42G	15 x 66 x 42	125	188	24	\$2917
D60SH42G	15 x 60 x 42	125	171	22	\$2815
D36SH42G	15 x 36 x 42	125	102	13	\$2198
D30SH42G	15 x 30 x 42	125	85	11	\$1598

One fixed shelf. Closed back features one grommet. Aluminum frame available in Tungsten finish only. All hutches shipped pre-assembled. Translucent, screened glass.

- Models 120" w- 108" w have three fixed shelf dividers.
- Models 84" w- 102" w have two fixed shelf dividers.
- Models 60" w - 78" w have one fixed shelf divider.
- Clearance from worksurface to valance is 25.5".
- Locks are not available on hutches with Glass Doors.

Required Specifications

Veneer Finish (Closed Hutch with Veneer Doors)
Laminate Finish (body - Hutches with Glass)
Handle Style

Optional Specifications

Lock (Closed Hutch with Veneer Doors)
Veneer Top (Closed Hutch with Veneer Doors)

Accessories

Tackboard
Tasklight

CLOSED HUTCHES

sizes 96"-84"w

sizes 78"-60"w

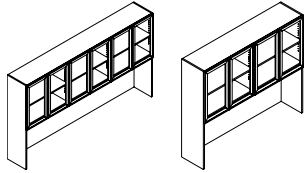

Closed Hutch w/Glass Doors 54" High

MODEL#	DIMENSIONS	FREIGHT CLASS	WT/LBS.	CUBIC FT.	VENEER/LAMINATE	ALL VENEER
D x W x H						
D962SH54G	15 x 96 x 54	125	351	45		\$5269
D902SH54G	15 x 90 x 54	125	329	42		\$4890
D842SH54G	15 x 84 x 54	125	307	39		\$4542
D782SH54G	15 x 78 x 54	125	285	37		\$4176
D722SH54G	15 x 72 x 54	125	263	34		\$3815
D662SH54G	15 x 66 x 54	125	241	31		\$3681
D602SH54G	15 x 60 x 54	125	219	28		\$3519

One fixed shelf and one adjustable shelf (per compartment). Closed back features one grommet. Aluminum frame available in Tungsten finish only. All hutches shipped pre-assembled. Translucent, screened glass.

- Clearance from worksurface to valance is 25.5".
- **Locks are not available on hutches with Glass Doors.**

sizes 120"-108"w

sizes 102"-84"w

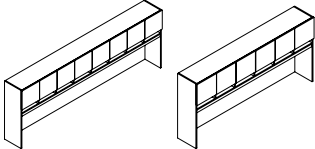

Closed Hutch w/Glass Doors Pigeon-Hole Storage, 42" High

D120SHP42G	15 x 120 x 42	125	341	44		\$5954
D114SHP42G	15 x 114 x 42	125	324	42		\$5695
D108SHP42G	15 x 108 x 42	125	307	39		\$5459
D102SHP42G	15 x 102 x 42	125	290	37		\$4954
D96SHP42G	15 x 96 x 42	125	273	35		\$4723
D90SHP42G	15 x 90 x 42	125	256	33		\$4709
D84SHP42G	15 x 84 x 42	125	239	31		\$4218
D78SHP42G	15 x 78 x 42	150	222	38		\$3977
D72SHP42G	15 x 72 x 42	125	205	26		\$3468
D66SHP42G	15 x 66 x 42	125	188	24		\$3357
D60SHP42G	15 x 60 x 42	125	171	22		\$3195
D36SHP42G	15 x 36 x 42	125	102	13		\$2075
D30SHP42G	15 x 30 x 42	125	85	11		\$1852

One fixed shelf. Closed back features one grommet. Aluminum frame available in Tungsten finish only. Horizontal pigeon-hole storage top mounted to hutch. All hutches shipped pre-assembled. Translucent, screened glass.

- Models 120"w- 108"w have three fixed shelf dividers.
- Models 84"w- 102"w have two fixed shelf dividers.
- Models 60"w - 78"w have one fixed shelf divider.
- Clearance from worksurface to valance is 21.5".
- **Locks are not available on hutches with Glass Doors.**

sizes 78"-60"w

sizes 30"-36"w

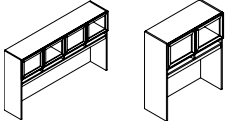

Closed Hutch w/Glass Doors Pigeon-Hole Storage, 54" High

D962SHP54G	15 x 96 x 54	125	351	45		\$6056
D902SHP54G	15 x 90 x 54	125	329	42		\$5644
D842SHP54G	15 x 84 x 54	125	307	39		\$5232
D782SHP54G	15 x 78 x 54	125	285	37		\$4820
D722SHP54G	15 x 72 x 54	125	263	34		\$4408
D662SHP54G	15 x 66 x 54	125	241	31		\$4250
D602SHP54G	15 x 60 x 54	125	219	28		\$4061

One fixed shelf and one adjustable shelf (per compartment). Closed back features one grommet. Aluminum frame available in Tungsten finish only. Horizontal pigeon-hole storage top mounted to hutch. All hutches shipped pre-assembled. Translucent, screened glass.

- Clearance from worksurface to valance is 21.5".
- **Locks are not available on hutches with Glass Doors.**

Required Specifications

Laminate Finish (body)

Accessories

Tackboard
Task Light

TACKBOARDS FOR OVERHEAD STORAGE & HUTCHES MODEL# DIMENSIONS FREIGHT CLASS WT/LBS. CUBIC FT. GR. 1-3 GR. 4-5

D x W x H

TACKBOARD Notes: Tackboards can be upholstered in all of the following fabrics:

Grade 1: Agate II, Drama, Jenny, Pebbles, Quilt, Sprinkle, Station, Urban

Grade 2: Crescent, Cumulus, Imprint, Lola, Match, Oxygen, Quantum, Renewal, Replay, Silhouette

Grade 3: Brinx, Couture, Mariposa

Grade 4: Accent

Grade 5: Meander, Tracery, Universe

WALL MOUNTED TACKBOARDS FOR OVERHEAD STORAGE GR. 1-3 GR. 4-5

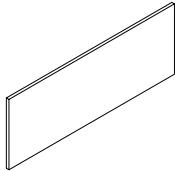

Tackboard

TS120	1 x 120 x 20	70	26	2	\$921	\$1151
TS114	1 x 114 x 20	70	25	2	\$877	\$1096
TS108	1 x 108 x 20	70	23	2	\$829	\$1037
TS102	1 x 102 x 20	85	19	2	\$786	\$982
TS96	1 x 96 x 20	70	17	1	\$734	\$918
TS90	1 x 90 x 20	70	15	1	\$690	\$863
TS84	1 x 84 x 20	70	14	1	\$647	\$809
TS78	1 x 78 x 20	70	13	1	\$599	\$749
TS72	1 x 72 x 20	70	12	1	\$375	\$469
TS66	1 x 66 x 20	85	11	1	\$345	\$432
TS60	1 x 60 x 20	85	10	1	\$316	\$396
TS54	1 x 54 x 20	85	10	1	\$286	\$358
TS48	1 x 48 x 20	85	10	1	\$256	\$320
TS42	1 x 42 x 20	85	10	1	\$226	\$283
TS36	1 x 36 x 20	100	8	1	\$201	\$252
TS30	1 x 30 x 20	150	5	1	\$167	\$209

For use on **16.5"H** overhead storage (**DCSFO_**, **DSF_**, **DSFF_**) at a finished height of **66"**. See Tackboard Notes above for exact fabric availability. List Price shown applies for all fabric grades.

- **NOTE:** Care should be taken to mount the units. Units should be mounted to wall studs using correct fasteners. Failure to do so may result in collapse of the unit and subsequent personal injury. **Mounting hardware not included.** Mounting hardware used should be based on wall material. Consult an installation professional for proper wall mounting.

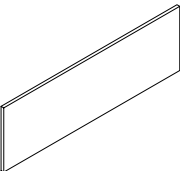

Tackboard

TS120H26	1 x 120 x 26	70	34	2	\$1198	\$1498
TS114H26	1 x 114 x 26	70	32	2	\$1139	\$1424
TS108H26	1 x 108 x 26	70	30	2	\$1079	\$1349
TS102H26	1 x 102 x 26	85	24	2	\$1016	\$1270
TS96H26	1 x 96 x 26	92.5	22	2	\$960	\$1200
TS90H26	1 x 90 x 26	92.5	20	2	\$901	\$1126
TS84H26	1 x 84 x 26	100	18	2	\$837	\$1047
TS78H26	1 x 78 x 26	100	17	2	\$778	\$972
TS72H26	1 x 72 x 26	70	16	1	\$482	\$603
TS66H26	1 x 66 x 26	85	14	1	\$443	\$554
TS60H26	1 x 60 x 26	85	13	1	\$405	\$507
TS54H26	1 x 54 x 26	85	13	1	\$371	\$464
TS48H26	1 x 48 x 26	85	13	1	\$328	\$411
TS42H26	1 x 42 x 26	85	13	1	\$290	\$363
TS36H26	1 x 36 x 26	100	8	1	\$252	\$316
TS30H26	1 x 30 x 26	150	5	1	\$213	\$267

For use on **16.5"H** overhead storage (**DCSFO_**, **DSF_**, **DSFF_**) at a finished height of **72"**. See Tackboard Notes above for exact fabric availability. List Price shown applies for all fabric grades.

- **NOTE:** Care should be taken to mount the units. Units should be mounted to wall studs using correct fasteners. Failure to do so may result in collapse of the unit and subsequent personal injury. **Mounting hardware not included.** Mounting hardware used should be based on wall material. Consult an installation professional for proper wall mounting.

Required Specifications

Fabric

WALL MOUNTED TACKBOARDS FOR OVERHEAD STORAGE MODEL# DIMENSIONS FREIGHT CLASS WT/LBS. CUBIC FT. GR. 1-3 GR. 4-5

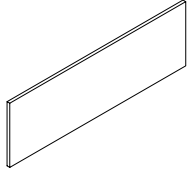

Tackboard

	D x W x H						
TSP120H23	1 x 120 x 23	70	34	2	\$1018	\$1300	
TSP114H23	1 x 114 x 23	70	32	2	\$971	\$1235	
TSP108H23	1 x 108 x 23	70	30	2	\$915	\$1171	
TSP102H23	1 x 102 x 23	85	24	2	\$872	\$1111	
TSP96H23	1 x 96 x 23	92.5	20	2	\$812	\$1042	
TSP90H23	1 x 90 x 23	92.5	20	1	\$761	\$972	
TSP84H23	1 x 84 x 23	70	18	1	\$714	\$908	
TSP78H23	1 x 78 x 23	70	17	1	\$663	\$804	
TSP72H23	1 x 72 x 23	70	16	1	\$616	\$772	
TSP66H23	1 x 66 x 23	85	14	1	\$560	\$700	
TSP60H23	1 x 60 x 23	85	13	1	\$405	\$507	
TSP54H23	1 x 54 x 23	85	13	1	\$513	\$642	
TSP48H23	1 x 48 x 23	85	13	1	\$406	\$411	
TSP42H23	1 x 42 x 23	85	13	1	\$355	\$363	
TSP36H23	1 x 36 x 23	100	8	1	\$308	\$316	
TSP30H23	1 x 30 x 23	150	5	1	\$253	\$267	

For use on **19.5"H** overhead storage (**DCSFOP_**, **DSFP_**, **DSFFP_**) with Pigeon-Hole Storage at a finished height of **72"**. See Tackboard Notes above for exact fabric availability. List Price shown applies for all fabric grades.

- **NOTE:** Care should be taken to mount the units. Units should be mounted to wall studs using correct fasteners. Failure to do so may result in collapse of the unit and subsequent personal injury. **Mounting hardware not included.** Mounting hardware used should be based on wall material. Consult an installation professional for proper wall mounting.

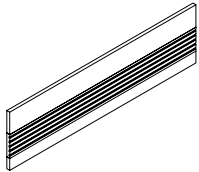

Tackboard - Accessory Rail

TSA120	1 x 120 x 20	85	26	2	\$1623	\$2029
TSA114	1 x 114 x 20	85	25	2	\$1544	\$1930
TSA108	1 x 108 x 20	92.5	23	2	\$1460	\$1825
TSA102	1 x 102 x 20	100	19	2	\$1385	\$1731
TSA96	1 x 96 x 20	70	15	1	\$1298	\$1622
TSA90	1 x 90 x 20	70	15	1	\$1218	\$1523
TSA84	1 x 84 x 20	85	14	1	\$1135	\$1419
TSA78	1 x 78 x 20	85	13	1	\$1056	\$1319
TSA72	1 x 72 x 20	85	12	1	\$972	\$1215
TSA66	1 x 66 x 20	92.5	11	1	\$893	\$1116
TSA60	1 x 60 x 20	92.5	10	1	\$810	\$1012
TSA54	1 x 54 x 20	92.5	10	1	\$730	\$913
TSA48	1 x 48 x 20	92.5	10	1	\$651	\$813
TSA42	1 x 42 x 20	92.5	10	1	\$567	\$709
TSA36	1 x 36 x 20	125	6	1	\$484	\$605
TSA30	1 x 30 x 20	150	4	1	\$377	\$471

For use on **16.5"H** overhead storage (**DCSFO_**, **DSF_**, **DSFF_**) at a finished height of **66"**. See Tackboard Notes above for exact fabric availability. List Price shown applies for all fabric grades.

- **Must Specify Black (E) or Tungsten (K) Accessory Rail finish.**
- **NOTE:** Care should be taken to mount the units. Units should be mounted to wall studs using correct fasteners. Failure to do so may result in collapse of the unit and subsequent personal injury. **Mounting hardware not included.** Mounting hardware used should be based on wall material. Consult an installation professional for proper wall mounting.

Required Specifications

- Fabric
- Accessory Rail Finish

WALL MOUNTED TACKBOARDS FOR OVERHEAD STORAGE MODEL# DIMENSIONS FREIGHT CLASS WT/LBS. CUBIC FT. GR. 1-3 GR. 4-5

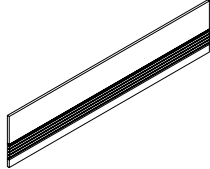

Tackboard - Accessory Rail

	D x W x H						
TSA120H26	1 x 120 x 26	85	26	2	\$1948	\$2436	
TSA114H26	1 x 114 x 26	85	25	2	\$1849	\$2312	
TSA108H26	1 x 108 x 26	92.5	23	2	\$1758	\$2197	
TSA102H26	1 x 102 x 26	100	19	2	\$1659	\$2073	
TSA96H26	1 x 96 x 26	70	15	1	\$1468	\$1835	
TSA90H26	1 x 90 x 26	70	15	1	\$1464	\$1830	
TSA84H26	1 x 84 x 26	85	14	1	\$1349	\$1687	
TSA78H26	1 x 78 x 26	85	13	1	\$1266	\$1582	
TSA72H26	1 x 72 x 26	85	12	1	\$1151	\$1438	
TSA66H26	1 x 66 x 26	92.5	11	1	\$1075	\$1344	
TSA60H26	1 x 60 x 26	92.5	10	1	\$972	\$1215	
TSA54H26	1 x 54 x 26	92.5	10	1	\$877	\$1096	
TSA48H26	1 x 48 x 26	92.5	10	1	\$782	\$977	
TSA42H26	1 x 42 x 26	92.5	10	1	\$687	\$858	
TSA36H26	1 x 36 x 26	125	6	1	\$583	\$729	
TSA30H26	1 x 30 x 26	150	4	1	\$488	\$610	

For use on 16.5" H overhead storage (DCSFO_, DSF_, DSFF_) at a finished height of 72". See Tackboard Notes above for exact fabric availability. List Price shown applies for all fabric grades.

- **Must Specify Black (E) or Tungsten (K) Accessory Rail finish.**
- **NOTE:** Care should be taken to mount the units. Units should be mounted to wall studs using correct fasteners. Failure to do so may result in collapse of the unit and subsequent personal injury. **Mounting hardware not included.** Mounting hardware used should be based on wall material. Consult an installation professional for proper wall mounting.

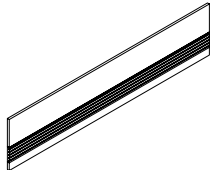

Tackboard - Accessory Rail

TSPA120H23	1 x 120 x 23	70	34	2	\$1774	\$2217
TSPA114H23	1 x 114 x 23	70	32	2	\$1679	\$2098
TSPA108H23	1 x 108 x 23	70	30	2	\$1583	\$1979
TSPA102H23	1 x 102 x 23	85	24	2	\$1508	\$1885
TSPA96H23	1 x 96 x 23	92.5	20	2	\$1413	\$1766
TSPA90H23	1 x 90 x 23	70	20	2	\$1325	\$1657
TSPA84H23	1 x 84 x 23	100	18	2	\$1234	\$1543
TSPA78H23	1 x 78 x 23	100	17	2	\$1147	\$1434
TSPA72H23	1 x 72 x 23	70	16	1	\$1060	\$1324
TSPA66H23	1 x 66 x 23	85	14	1	\$972	\$1215
TSPA60H23	1 x 60 x 23	85	13	1	\$881	\$1101
TSPA54H23	1 x 54 x 23	85	13	1	\$778	\$972
TSPA48H23	1 x 48 x 23	85	13	1	\$706	\$883
TSPA42H23	1 x 42 x 23	85	13	1	\$619	\$774
TSPA36H23	1 x 36 x 23	100	6	1	\$532	\$665
TSPA30H23	1 x 30 x 23	150	4	1	\$440	\$551

For use on 19.5" H overhead storage (DCSFOP_, DSFP_, DSFFP_) with Pigeon-Hole Storage at a finished height of 72". See Tackboard Notes above for exact fabric availability. List Price shown applies for all fabric grades.

- **Must Specify Black (E) or Tungsten (K) Accessory Rail finish.**
- **NOTE:** Care should be taken to mount the units. Units should be mounted to wall studs using correct fasteners. Failure to do so may result in collapse of the unit and subsequent personal injury. **Mounting hardware not included.** Mounting hardware used should be based on wall material. Consult an installation professional for proper wall mounting.

Required Specifications

- Fabric
- Accessory Rail Finish

TACKBOARDS FOR HUTCHES

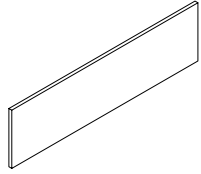

Tackboard

MODEL#	DIMENSIONS D x W x H	FREIGHT CLASS	WT/LBS.	CUBIC FT.	GR. 1-3	GR. 4-5
DTS120	1 x 118 x 20	70	26	2	\$609	\$762
DTS114	1 x 112 x 20	70	25	2	\$579	\$724
DTS108	1 x 106 x 20	70	23	2	\$550	\$688
DTS102	1 x 100 x 20	85	19	2	\$520	\$650
DTS96	1 x 94 x 20	70	15	1	\$490	\$613
DTS90	1 x 88 x 20	70	15	1	\$465	\$582
DTS84	1 x 82 x 20	70	14	1	\$435	\$544
DTS78	1 x 76 x 20	70	13	1	\$405	\$507
DTS72	1 x 70 x 20	70	12	1	\$375	\$469
DTS66	1 x 64 x 20	85	11	1	\$345	\$432
DTS60	1 x 58 x 20	85	10	1	\$316	\$396
DTS36	1 x 34 x 20	100	6	1	\$201	\$252
DTS30	1 x 28 x 20	150	4	1	\$167	\$209

For use on **36" H** hutches (**D_SH36, D_SH36G, D_SH36DGD, D_SH36GDG**). **Factory installed**, with velcro tape. Please specify hutch to be installed on. *See Tackboard Notes above for exact fabric availability.* List Price shown applies for all fabric grades.

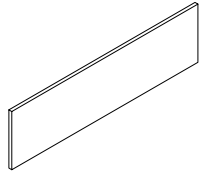

Tackboard

DTS120H26	1 x 118 x 26	70	34	2	\$788	\$985
DTS114H26	1 x 112 x 26	70	32	2	\$750	\$938
DTS108H26	1 x 106 x 26	70	30	2	\$711	\$889
DTS102H26	1 x 100 x 26	85	24	2	\$673	\$842
DTS96H26	1 x 94 x 26	92.5	20	2	\$635	\$794
DTS90H26	1 x 88 x 26	92.5	20	2	\$596	\$746
DTS84H26	1 x 82 x 26	100	18	2	\$558	\$698
DTS78H26	1 x 76 x 26	100	17	2	\$520	\$650
DTS72H26	1 x 70 x 26	70	16	1	\$482	\$603
DTS66H26	1 x 64 x 26	85	14	1	\$443	\$554
DTS60H26	1 x 58 x 26	85	13	1	\$405	\$507
DTS36H26	1 x 34 x 26	100	8	1	\$252	\$316
DTS30H26	1 x 28 x 26	150	5	1	\$213	\$267

For use on **42" H and 54" H** hutches (**D_SH42/54, D_SH42/54G, D_SH42/54DGD, D_SH42/54GDG**). **Factory installed**, with velcro tape. Please specify hutch to be installed on. *See Tackboard Notes above for exact fabric availability.* List Price shown applies for all fabric grades.

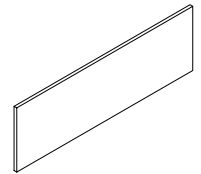

Tackboard

DTSP120H23	1 x 118 x 23	70	34	2	\$788	\$985
DTSP114H23	1 x 112 x 23	70	32	2	\$750	\$938
DTSP108H23	1 x 106 x 23	70	30	2	\$711	\$889
DTSP102H23	1 x 100 x 23	85	24	2	\$673	\$842
DTSP96H23	1 x 94 x 23	92.5	20	2	\$635	\$794
DTSP90H23	1 x 88 x 23	92.5	20	1	\$596	\$746
DTSP84H23	1 x 82 x 23	70	18	1	\$558	\$698
DTSP78H23	1 x 76 x 23	70	17	1	\$520	\$650
DTSP72H23	1 x 70 x 23	70	16	1	\$482	\$603
DTSP66H23	1 x 64 x 23	85	14	1	\$443	\$554
DTSP60H23	1 x 58 x 23	85	13	1	\$405	\$507
DTSP54H23	1 x 52 x 23	85	13	1	\$371	\$464
DTSP48H23	1 x 46 x 23	85	13	1	\$328	\$411
DTSP42H23	1 x 40 x 23	85	13	1	\$290	\$363
DTSP36H23	1 x 34 x 23	100	8	1	\$252	\$316
DTSP30H23	1 x 28 x 23	150	5	1	\$213	\$267

For use on **42" H and 54" H** hutches (**D_SHP42/54, D_SHP42/54G, D_SHP42/54DGD, D_SHP42/54GDG**) with Pigeon-Hole Storage. **Factory installed**, with velcro tape. Please specify hutch to be installed on. *See Tackboard Notes above for exact fabric availability.* List Price shown applies for all fabric grades.

Required Specifications

Fabric

TACKBOARDS FOR HUTCHES

MODEL#	DIMENSIONS	FREIGHT CLASS	WT/LBS.	CUBIC FT.	GR. 1-3	GR. 4-5
	D x W x H					
DTSA120	1 x 118 x 20	85	26	2	\$1065	\$1332
DTSA114	1 x 112 x 20	85	25	2	\$1014	\$1268
DTSA108	1 x 106 x 20	92.5	23	2	\$958	\$1198
DTSA102	1 x 100 x 20	100	19	2	\$907	\$1134
DTSA96	1 x 94 x 20	70	15	1	\$852	\$1066
DTSA90	1 x 88 x 20	70	15	1	\$805	\$1007
DTSA84	1 x 82 x 20	85	14	1	\$750	\$938
DTSA78	1 x 76 x 20	85	13	1	\$699	\$874
DTSA72	1 x 70 x 20	85	12	1	\$648	\$810
DTSA66	1 x 64 x 20	92.5	11	1	\$592	\$741
DTSA60	1 x 58 x 20	92.5	10	1	\$541	\$677
DTSA54	1 x 52 x 20	92.5	10	1	\$490	\$613
DTSA48	1 x 46 x 20	92.5	10	1	\$439	\$549
DTSA42	1 x 40 x 20	92.5	10	1	\$388	\$486
DTSA36	1 x 34 x 20	125	6	1	\$333	\$417
DTSA30	1 x 28 x 20	150	4	1	\$281	\$352

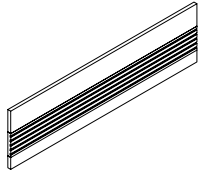

Tackboard - Accessory Rail

For use on 36”H hutches (D_SH36, D_SH36G, D_SH36DGD, D_SH36GDG). **Factory installed**, with velcro tape. Please specify hutch to be installed on. See Tackboard Notes above for exact fabric availability. List Price shown applies for all fabric grades.

- **Must Specify Black (E) or Tungsten (K) Accessory Rail finish.**

DTSA120H26	1 x 118 x 26	85	26	2	\$1273	\$1592
DTSA114H26	1 x 112 x 26	85	25	2	\$1210	\$1513
DTSA108H26	1 x 106 x 26	92.5	23	2	\$1150	\$1438
DTSA102H26	1 x 100 x 26	100	19	2	\$1086	\$1358
DTSA96H26	1 x 94 x 26	70	15	1	\$1022	\$1278
DTSA90H26	1 x 88 x 26	70	15	1	\$963	\$1204
DTSA78H26	1 x 76 x 26	85	13	1	\$835	\$1044
DTSA72H26	1 x 70 x 26	85	12	1	\$758	\$948
DTSA66H26	1 x 64 x 26	92.5	11	1	\$711	\$889
DTSA60H26	1 x 58 x 26	92.5	10	1	\$648	\$810
DTSA54H26	1 x 52 x 26	92.5	10	1	\$584	\$731
DTSA48H26	1 x 46 x 26	92.5	10	1	\$524	\$656
DTSA42H26	1 x 40 x 26	92.5	10	1	\$460	\$576
DTSA36H26	1 x 34 x 26	125	6	1	\$396	\$495
DTSA30H26	1 x 28 x 26	150	4	1	\$337	\$422

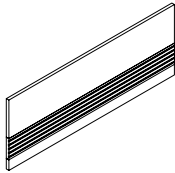

Tackboard - Accessory Rail

For use on 42”H and 54”H hutches (D_SH42/54, D_SH42/54G, D_SH42/54DGD, D_SH42/54GDG). **Factory installed**, with velcro tape. Please specify hutch to be installed on. See Tackboard Notes above for exact fabric availability. List Price shown applies for all fabric grades.

- **Must Specify Black (E) or Tungsten (K) Accessory Rail finish.**

Required Specifications

- Fabric
- Accessory Rail Finish

D DUFFERIN

TACKBOARDS FOR HUTCHES

MODEL# DIMENSIONS FREIGHT CLASS WT/LBS. CUBIC FT. VENEER/LAMINATE ALL VENEER

D x W x H

DTSPA120H23	1 x 118 x 23	70	34	2	\$1324	\$1655
DTSPA114H23	1 x 112 x 23	70	32	2	\$1261	\$1577
DTSPA108H23	1 x 106 x 23	70	30	2	\$1192	\$1490
DTSPA102H23	1 x 100 x 23	85	24	2	\$1137	\$1422
DTSPA96H23	1 x 94 x 23	92.5	20	2	\$1065	\$1332
DTSPA90H23	1 x 88 x 23	92.5	20	2	\$1001	\$1252
DTSPA84H23	1 x 82 x 23	100	18	2	\$933	\$1167
DTSPA78H23	1 x 76 x 23	100	17	2	\$869	\$1087
DTSPA72H23	1 x 70 x 23	70	16	1	\$805	\$1007
DTSPA66H23	1 x 64 x 23	85	14	1	\$737	\$922
DTSPA60H23	1 x 58 x 23	85	13	1	\$673	\$842
DTSPA54H23	1 x 52 x 23	85	13	1	\$609	\$762
DTSPA48H23	1 x 46 x 23	85	13	1	\$541	\$677
DTSPA42H23	1 x 40 x 23	85	13	1	\$477	\$597
DTSPA36H23	1 x 34 x 23	100	8	1	\$413	\$517
DTSPA30H23	1 x 28 x 23	150	5	1	\$350	\$438

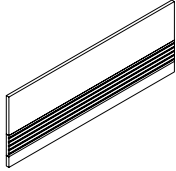

Tackboard - Accessory Rail

For use on **42"H and 54"H** hutches (**D_SHP42/54, D_SHP42/54G, D_SHP42/54DGD, D_SHP42/54GDG**) with Pigeon-Hole Storage. **Factory installed**, with velcro tape. Please specify hutch to be installed on. See *Tackboard Notes above* for exact fabric availability. List Price shown applies for all fabric grades.

- **Must Specify Black (E) or Tungsten (K) Accessory Rail finish.**

HUTCH ACCESSORIES

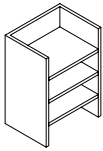

Vertical Pigeon-Hole Storage Letter

DCPH131226	12 x 13 x 26	100	16	2	\$386	\$464
DCPH131223	12 x 13 x 23	125	15	2	\$328	\$394
DCPH131219	12 x 13 x 19	125	12	2	\$248	\$298

Used in conjunction with overhead storage units and hutches that incorporate horizontal pigeon-hole storage. Not freestanding. Shipped RTA (ready to assemble).

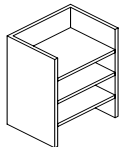

Vertical Pigeon-Hole Storage Legal

DCPH161226	12 x 16 x 26	125	20	3	\$476	\$572
DCPH161223	12 x 16 x 23	125	18	3	\$403	\$484
DCPH161219	12 x 16 x 19	125	15	2	\$305	\$366

Used in conjunction with overhead storage units and hutches that incorporate horizontal pigeon-hole storage. Not freestanding. Shipped RTA (ready to assemble).

Required Specifications

Fabric (Tackboard)
Accessory Rail Finish
Veneer Finish (Pigeon Hole Storage)
Laminate Finish (Pigeon Hole Storage)

ACCESSORY RAIL/PANEL ORGANIZERS MODEL# DIMENSIONS FREIGHT CLASS WT/LBS. CUBIC FT. LIST PRICE

D x W x H

Available Finishes:	BLK	Black	SIL	Silver
	CHR	Charcoal	TPE	Taupe
	DWT	Designer White	TUN	Tungsten
	NEV	Nevada		

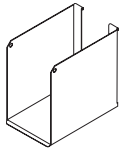

Binder Bin

BABB01	10.25 x 4 x 9	100	2	.21	\$51
--------	---------------	-----	---	-----	-------------

Load bar/accessory rail mounted metal binder bin.

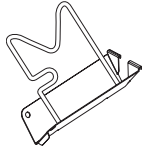

Flip Sorter

BAFS01	9.25 x 2.75 x 9.25	70	.06	.14	\$38
--------	--------------------	----	-----	-----	-------------

Load bar/accessory rail mounted metal flip sorter. Comes with chrome wire.

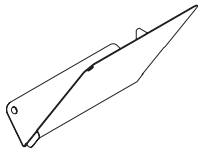

Slant Sorter

BASS01L (Left)	10.25 x 5 x 9.5	70	1	.28	\$32
BASS01R (Right)	10.25 x 5 x 9.5	70	1	.28	\$32

Load bar/accessory rail mounted metal slant sorter.

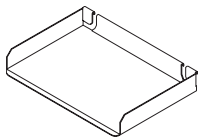

Letter Tray

BALTO1	9.25 x 13.5 x 2	70	.50	.15	\$41
--------	-----------------	----	-----	-----	-------------

Load bar/accessory rail mounted metal letter tray.

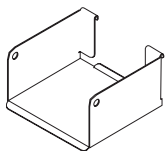

Media Bin

BAMB01	5.25 x 5.75 x 3	70	.08	.05	\$41
--------	-----------------	----	-----	-----	-------------

Load bar/accessory rail mounted metal media bin.

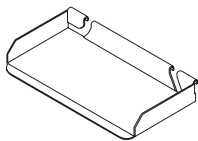

Utility Tray

BAUTO1	3.75 x 5.75 x 3	70	.05	.02	\$27
--------	-----------------	----	-----	-----	-------------

Load bar/accessory rail mounted metal utility tray.

Required Specifications

Metal Finish

D DUFFERIN

ACCESSORY RAIL/PANEL ORGANIZERS

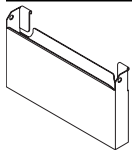

Mail Box

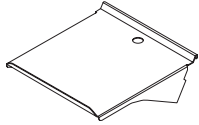

Telephone Holder

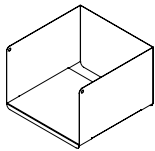

Elevated Shelf Binder Bin

MODEL#	DIMENSIONS D x W x H	FREIGHT CLASS	WT/LBS.	CUBIC FT.	LIST PRICE
BAPP01	2.75 x 16 x 9	100	2	.25	\$66
Load bar/accessory rail mounted metal mail box.					
BATH01	10 x 9 x 2	125	2	.26	\$63
Load bar/accessory rail mounted metal telephone holder.					
BRTESBBIN	12 x 12 x 8	100	6	.66	\$137
Load bar/accessory rail mounted elevated shelf binder bin.					

BOOKCASES

VENEER/LAMINATE ALL VENEER

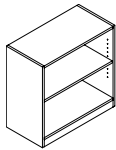

Bookcase - 29" High

DB23615	15 x 36 x 29	92.5	90	9	\$854	\$1025
DB23015	15 x 30 x 29	92.5	90	8	\$748	\$898
Includes one adjustable veneer shelf. Shelf is 3/4" thick.						

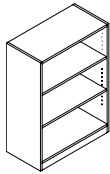

Bookcase - 48" High

DB43615	15 x 36 x 48	100	140	15	\$1067	\$1281
DB43015	15 x 30 x 48	92.5	140	13	\$934	\$1121
Includes two adjustable veneer shelves. Shelf is 3/4" thick.						

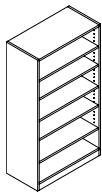

Bookcase - 66" High

DB53615	15 x 36 x 66	100	188	21	\$1295	\$1554
DB53015	15 x 30 x 66	92.5	188	17	\$1133	\$1360
Includes five adjustable veneer shelves. Shelf is 3/4" thick.						

Required Specifications

- Metal Finish (Accessories)
- Veneer Finish (Shelves)
- Laminate Finish (top/body)

BOOKCASES

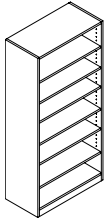

Bookcase - 72" High

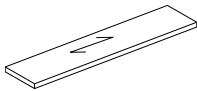

Tops 15" Deep

MODEL#	DIMENSIONS D x W x H	FREIGHT CLASS	WT/LBS.	CUBIC FT.	veneer/LAMINATE	ALL VENEER
DB63615	15 x 36 x 72	100	210	23	\$1405	\$1686
DB63015	15 x 30 x 72	92.5	210	19	\$1230	\$1476

Includes **six adjustable** veneer shelves. Shelf is ¾" thick.

DT3617D	17 x 36 x 1	65	27	1	N/A	\$418
DT3017D	17 x 30 x 1	65	23	1	N/A	\$348

For use with 15" deep bookcases. Tops are 1" thick.

END SHELVES

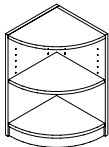

End Shelf - 29" High

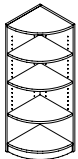

End Shelf - 48" High

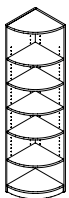

End Shelf - 66" High

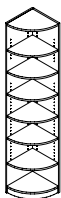

End Shelf - 72" High

DB2R1515	15 x 15 x 29	100	37	4	\$673	\$808
----------	--------------	-----	----	---	--------------	--------------

For use at end of **worksurfaces or storage modules**. Includes one adjustable veneer shelf. Shipped RTA (ready to assemble).

DB4R1515	15 x 15 x 48	100	59	6	\$839	\$1007
----------	--------------	-----	----	---	--------------	---------------

For use at end of **storage modules or wardrobe cabinets**. Includes **three adjustable** veneer shelves. Shipped RTA (ready to assemble).

DB5R1515	15 x 15 x 66	100	81	9	\$1020	\$1224
----------	--------------	-----	----	---	---------------	---------------

For use at end of **storage modules, wardrobe cabinets or personal towers**. Includes **five adjustable** veneer shelves. Shipped RTA (ready to assemble).

DB6R1515	15 x 15 x 72	100	83	9	\$1108	\$1330
----------	--------------	-----	----	---	---------------	---------------

For use at end of **storage modules, wardrobe cabinets or personal towers**. Includes **six adjustable** veneer shelves. Shipped RTA (ready to assemble).

Required Specifications

- Veneer Finish (Shelves)
- Laminate Finish (top/body)

D DUFFERIN

END SHELVES

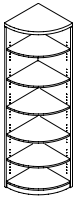

End Shelf - 66" High

MODEL#	DIMENSIONS D x W x H	FREIGHT CLASS	WT/LBS.	CUBIC FT.	veneer/LAMINATE	ALL VENEER
DB7R2424	24 x 24 x 66	100	187	22	\$1862	\$2235
DB7R2222	22 x 22 x 66	100	157	18	\$1621	\$1946
DB7R2020	20 x 20 x 66	100	130	15	\$1546	\$1856

For use at end of **storage modules, wardrobe cabinets or personal towers**. Includes **five adjustable** veneer shelves. Shipped RTA (ready to assemble).

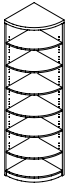

End Shelf - 72" High

DB7R2424H72	24 x 24 x 72	125	204	28	\$2033	\$2440
DB7R2222H72	22 x 22 x 72	100	171	20	\$1770	\$2124
DB7R2020H72	20 x 20 x 72	100	142	17	\$1686	\$2024

For use at end of **storage modules, wardrobe cabinets or personal towers**. Includes **six adjustable** veneer shelves. Shipped RTA (ready to assemble).

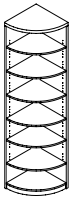

End Shelf - 84" High

DB7R2424H84	24 x 24 x 84	100	234	28	\$2371	\$2846
DB7R2222H84	22 x 22 x 84	100	189	20	\$2172	\$2607
DB7R2020H84	20 x 20 x 84	100	163	19	\$2070	\$2484

For use at end of **storage modules, wardrobe cabinets or personal towers**. Includes **seven adjustable** veneer shelves. Shipped RTA (ready to assemble).

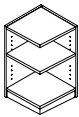

End Shelf - 29" High - Square

DB2S1515	15 x 15 x 29	100	37	4	\$709	\$851
----------	--------------	-----	----	---	--------------	--------------

For use at end of **worksurfaces or storage modules**. Includes **one adjustable** veneer shelf. Shipped RTA (ready to assemble).

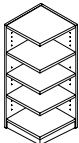

End Shelf - 48" High - Square

DB4S1515	15 x 15 x 48	100	59	6	\$885	\$1062
----------	--------------	-----	----	---	--------------	---------------

For use at end of **storage modules or wardrobe cabinets**. Includes **three adjustable** veneer shelves. Shipped RTA (ready to assemble).

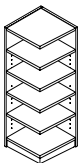

End Shelf - 66" High - Square

DB5S1515	15 x 15 x 66	100	81	9	\$1075	\$1290
----------	--------------	-----	----	---	---------------	---------------

For use at end of **storage modules, wardrobe cabinets or personal towers**. Includes **five adjustable** veneer shelves. Shipped RTA (ready to assemble).

Required Specifications

Veneer Finish (Shelves)
Laminate Finish (top/body)

END SHELVES

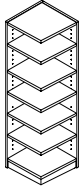

End Shelf - 72" High - Square

MODEL#	DIMENSIONS D x W x H	FREIGHT CLASS	WT/LBS.	CUBIC FT.	VENEER/LAMINATE	ALL VENEER
DB6S1515	15 x 15 x 72	100	83	9	\$1167	\$1401

For use at end of **storage modules, wardrobe cabinets or personal towers**. Includes **six adjustable** veneer shelves. Shipped RTA (ready to assemble).

RECEPTION DESKS

- To add storage use storage shells. See pages 40-42.
- Includes GM1 grommet.
- Transaction tops to be specified separately, handed by square edge from user side.
- Decorative Front Panels should be specified separately. Size chosen should be 12" less than desk dimensions. Available in Reverse Diamond, Vertical Rib, Vertical Grain and Horizontal Grain Patterns.

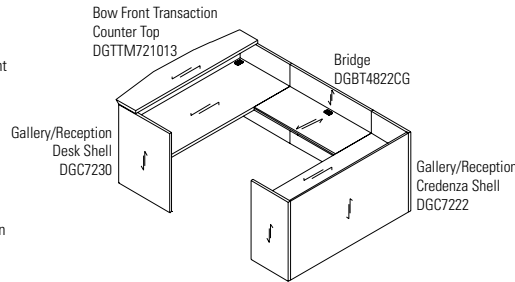
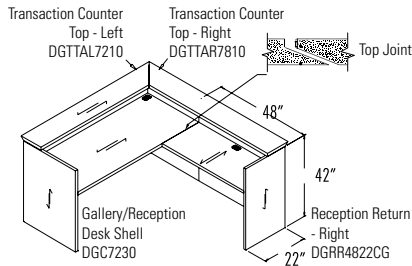

OPTION DETAILS

Decorative Front Panel (Reverse Diamond Pattern)
DGFDP5430F

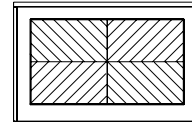

Decorative Front Panel (Vertical Rib Pattern)
DGFDP5430RIB

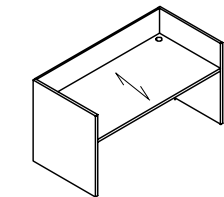
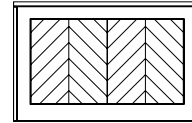

Gallery/Reception Desk Shell

DGC10836	36 x 108 x 42	150	533	95	\$4371	\$5246
DGC10236	36 x 102 x 42	150	503	89	\$4128	\$4954
DGC9636	36 x 96 x 42	150	473	84	\$3885	\$4662
DGC9036	36 x 90 x 42	150	444	79	\$3643	\$4372
DGC8436	36 x 84 x 42	150	414	74	\$3399	\$4079
DGC7236	36 x 72 x 42	150	355	63	\$2914	\$3497
DGC7230	30 x 72 x 42	150	315	53	\$2819	\$3383
DGC6630	30 x 66 x 42	125	295	48	\$2540	\$3048
DGC6030	30 x 60 x 42	125	275	44	\$2748	\$3298

No pedestals. Two grommets in worksurface. For use with modular storage components.

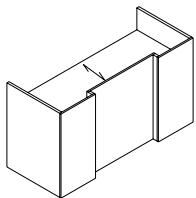

Gallery/Reception Desk Shell
Breakfront Style

DGIC10836	36 x 108 x 42	150	533	95	\$5371	\$6446
DGIC10236	36 x 102 x 42	150	503	89	\$5073	\$6088
DGIC9636	36 x 96 x 42	150	473	84	\$4775	\$5730
DGIC9036	36 x 90 x 42	150	444	79	\$4477	\$5373
DGIC8436	36 x 84 x 42	150	414	74	\$4179	\$5015
DGIC7236	36 x 72 x 42	150	355	63	\$3582	\$4299
DGIC7230	30 x 72 x 42	150	315	53	\$3464	\$4157
DGIC6630	30 x 66 x 42	125	295	48	\$3378	\$4054
DGIC6030	30 x 60 x 42	125	275	44	\$3186	\$3824

No pedestals. Two grommets in worksurface. For use with modular storage components.

Required Specifications

Veneer Finish
Laminate Finish

Optional Specifications

Additional Grommet (Reception Desks)
Decorative Panel (DGC models)

Accessories

Storage Shells (Reception Desks)

RECEPTION DESKS

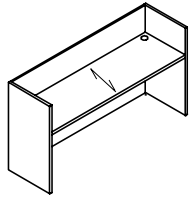

Gallery/Reception Credenza Shell

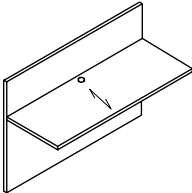

Bridge

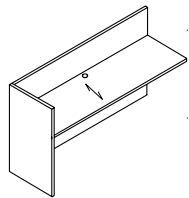

Reception Return - LEFT

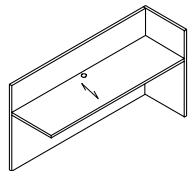

Reception Return - RIGHT

MODEL#	DIMENSIONS D x W x H	FREIGHT CLASS	WT/LBS.	CUBIC FT.	VENEER/LAMINATE	ALL VENEER
DGC10824	24 x 108 x 42	150	353	63	\$3426	\$4112
DGC10224	24 x 102 x 42	150	333	60	\$3236	\$3884
DGC9624	24 x 96 x 42	150	314	56	\$3045	\$3654
DGC9024	24 x 90 x 42	150	294	53	\$2854	\$3425
DGC8424	24 x 84 x 42	150	274	49	\$2664	\$3197
DGC7224	24 x 72 x 42	150	235	42	\$2284	\$2741
DGC6624	24 x 66 x 42	150	216	39	\$2147	\$2577
DGC6024	24 x 60 x 42	150	196	35	\$2011	\$2414

No pedestals. Two grommets in worksurface. For use with modular storage components.

DGBT5624CG	24 x 56 x 42	150	178	32	\$1916	\$2300
DGBT5424CG	24 x 54 x 42	150	169	29	\$1916	\$2300
DGBT5024CG	24 x 50 x 42	150	151	27	\$1701	\$2042
DGBT4824CG	24 x 48 x 42	150	142	26	\$1701	\$2042
DGBT4424CG	24 x 44 x 42	150	134	23	\$1489	\$1787
DGBT4224CG	24 x 42 x 42	150	127	22	\$1489	\$1787
DGBT3824CG	24 x 38 x 42	150	119	20	\$1341	\$1610
DGBT3624CG	24 x 36 x 42	150	112	19	\$1341	\$1610

Attaches between **Gallery Desk and Gallery Credenza Only**. One grommet in center of worksurface. Shipped RTA (ready to assemble).

- To remove cross-grain veneer pattern on top, **delete "CG"** from model number. Available as a special - no upcharge.

DGRL7224	24 x 72 x 42	125	273	42	\$2877	\$3453
DGRL6624	24 x 66 x 42	125	250	39	\$2637	\$3165
DGRL6024	24 x 60 x 42	125	228	35	\$2398	\$2878
DGRL5424	24 x 54 x 42	125	205	32	\$2158	\$2590
DGRL4824	24 x 48 x 42	125	182	28	\$1918	\$2302
DGRL4224	24 x 42 x 42	125	159	25	\$1678	\$2014
DGRL3624	24 x 36 x 42	125	137	21	\$1510	\$1812

No pedestal. One grommet in center of worksurface. For use with modular storage components.

DGRR7224	24 x 72 x 42	125	273	42	\$2877	\$3453
DGRR6624	24 x 66 x 42	125	250	39	\$2637	\$3165
DGRR6024	24 x 60 x 42	125	228	35	\$2398	\$2878
DGRR5424	24 x 54 x 42	125	205	32	\$2158	\$2590
DGRR4824	24 x 48 x 42	125	182	28	\$1918	\$2302
DGRR4224	24 x 42 x 42	125	159	25	\$1678	\$2014
DGRR3624	24 x 36 x 42	125	137	21	\$1510	\$1812

No pedestal. One grommet in center of worksurface. For use with modular storage components.

Required Specifications

Veneer Finish
Laminate Finish

Optional Specifications

Additional Grommet

Accessories

Storage Shells (*not available on Bridges*)

RECEPTION DESKS

MODEL# DIMENSIONS FREIGHT CLASS WT/LBS. CUBIC FT. VENEER/LAMINATE ALL VENEER

D x W x H

DGTT10810	10 x 108 x 1.50	100	78	8	N/A	\$809
DGTT10210	10 x 102 x 1.50	92.5	72	7	N/A	\$765
DGTT9610	10 x 96 x 1.50	100	66	7	N/A	\$720
DGTT9010	10 x 90 x 1.50	92.5	60	6	N/A	\$675
DGTT8410	10 x 84 x 1.50	100	54	6	N/A	\$630
DGTT7210	10 x 72 x 1.50	100	48	5	N/A	\$539
DGTT6610	10 x 66 x 1.50	100	42	5	N/A	\$494
DGTT6010	10 x 60 x 1.50	100	36	4	N/A	\$450

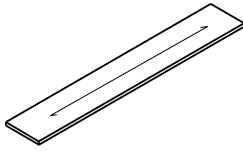

Transaction Counter Top

Rectangular top for main reception desk. Counter sits on top of Gallery panels. Does not overhang. **Factory installed - specify Gallery to be used on.** Size must match dimension of desk front or combined desk side and return length. Hardware included.

DGTTM1081013	10-13 x 108 x 1.50	125	78	10	N/A	\$1618
DGTTM1021013	10-13 x 102 x 1.50	100	72	9	N/A	\$1797
DGTTM961013	10-13 x 96 x 1.50	125	66	9	N/A	\$1439
DGTTM901013	10-13 x 90 x 1.50	125	60	8	N/A	\$1349
DGTTM841013	10-13 x 84 x 1.50	125	54	8	N/A	\$1259
DGTTM721013	10-13 x 72 x 1.50	125	48	7	N/A	\$1079
DGTTM661013	10-13 x 66 x 1.50	125	42	6	N/A	\$989
DGTTM601013	10-13 x 60 x 1.50	125	36	5	N/A	\$899

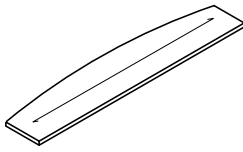

Bow Front Transaction Counter Top

Bow top for main reception desk. Counter sits on top of Gallery panels. Bow front overhangs 3". **Factory installed - specify Gallery to be used on.** Size must match dimension of desk front or combined desk side and return length. Hardware included.

DGTTA10810	10 x 108 x 1.50	100	78	8	N/A	\$918
DGTTA10210	10 x 102 x 1.50	92.5	72	7	N/A	\$873
DGTTA9610	10 x 96 x 1.50	100	66	7	N/A	\$828
DGTTA9010	10 x 90 x 1.50	92.5	60	6	N/A	\$783
DGTTA8410	10 x 84 x 1.50	100	54	6	N/A	\$739
DGTTA7210	10 x 72 x 1.50	100	48	5	N/A	\$649
DGTTA6610	10 x 66 x 1.50	100	42	5	N/A	\$604
DGTTA6010	10 x 60 x 1.50	100	36	4	N/A	\$558

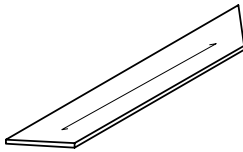

Trapezoid Transaction Counter Top

Trapezoid top for main reception desk. 45° mitered ends on left and right. For use with left and right 45° mitered return transaction counters. Counter sits on top of Gallery panels. Does not overhang. **Factory installed - specify Gallery to be used on.** Width must match dimension of desk front. Hardware included.

DGTTMA1081013	10-13 x 108 x 1.50	125	78	10	N/A	\$1726
DGTTMA1021013	10-13 x 102 x 1.50	100	72	9	N/A	\$1635
DGTTMA961013	10-13 x 96 x 1.50	125	66	9	N/A	\$1547
DGTTMA901013	10-13 x 90 x 1.50	125	60	8	N/A	\$1457
DGTTMA841013	10-13 x 84 x 1.50	125	54	8	N/A	\$1368
DGTTMA721013	10-13 x 72 x 1.50	125	48	7	N/A	\$1187
DGTTMA661013	10-13 x 66 x 1.50	125	42	6	N/A	\$1097
DGTTMA601013	10-13 x 60 x 1.50	125	36	5	N/A	\$1008

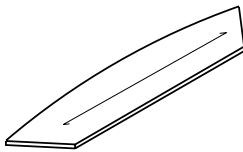

Bow Front Trapezoid Transaction Counter Top

Trapezoid bow top for main reception desk. 45° mitered ends on left and right. For use with left and right 45° mitered return transaction counters. Counter sits on top of Gallery panels. Bow front overhangs 3". **Factory installed - specify Gallery to be used on.** Width must match dimension of desk front. Hardware included.

Required Specifications

Veneer Finish

RECEPTION DESKS

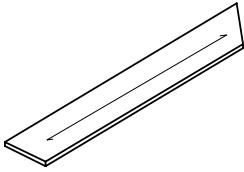

Transaction Counter Top - LEFT

MODEL#	DIMENSIONS D x W x H	FREIGHT CLASS	WT/LBS.	CUBIC FT.	VENEER/LAMINATE	ALL VENEER
DGTTAL12010	10 x 120 x 1.50	92.5	84	8	N/A	\$971
DGTTAL11410	10 x 114 x 1.50	92.5	81	8	N/A	\$921
DGTTAL10810	10 x 108 x 1.50	100	78	8	N/A	\$881
DGTTAL10210	10 x 102 x 1.50	92.5	72	7	N/A	\$837
DGTTAL9610	10 x 96 x 1.50	100	66	7	N/A	\$792
DGTTAL9010	10 x 90 x 1.50	92.5	60	6	N/A	\$747
DGTTAL8410	10 x 84 x 1.50	100	54	6	N/A	\$702
DGTTAL7210	10 x 72 x 1.50	100	48	5	N/A	\$612
DGTTAL6610	10 x 66 x 1.50	100	42	5	N/A	\$567
DGTTAL6010	10 x 60 x 1.50	100	36	4	N/A	\$523
DGTTAL3610	10 x 36 x 1.50	100	24	3	N/A	\$314
DGTTAL3010	10 x 30 x 1.50	92.5	20	2	N/A	\$262
DGTTAL2410	10 x 24 x 1.50	100	16	2	N/A	\$230

Rectangular top for main reception desk with 45° mitered end on **left**. For use with rectangular or bow front transaction counters with miters at both ends. Width must match dimension of Gallery Desk end and Return width. Counter sits on top of Gallery panels. Does not overhang. **Factory installed - specify Gallery to be used on**. Hardware included.

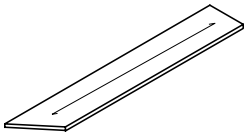

Transaction Counter Top - RIGHT

DGTTAR12010	10 x 120 x 1.50	92.5	84	8	N/A	\$971
DGTTAR11410	10 x 114 x 1.50	92.5	81	8	N/A	\$921
DGTTAR10810	10 x 108 x 1.50	100	78	8	N/A	\$881
DGTTAR10210	10 x 102 x 1.50	92.5	72	7	N/A	\$837
DGTTAR9610	10 x 96 x 1.50	100	66	7	N/A	\$792
DGTTAR9010	10 x 90 x 1.50	92.5	60	6	N/A	\$747
DGTTAR8410	10 x 84 x 1.50	100	54	6	N/A	\$702
DGTTAR7210	10 x 72 x 1.50	100	48	5	N/A	\$612
DGTTAR6610	10 x 66 x 1.50	100	42	5	N/A	\$567
DGTTAR6010	10 x 60 x 1.50	100	36	4	N/A	\$523
DGTTAR3610	10 x 36 x 1.50	100	24	3	N/A	\$314
DGTTAR3010	10 x 30 x 1.50	92.5	20	2	N/A	\$262
DGTTAR2410	10 x 24 x 1.50	100	16	2	N/A	\$230

Rectangular top for main reception desk with 45° mitered end on **right**. For use with rectangular or bow front transaction counters with miters at both ends. Width must match dimension of Gallery Desk end and Return width. Counter sits on top of Gallery panels. Does not overhang. **Factory installed - specify Gallery to be used on**. Hardware included.

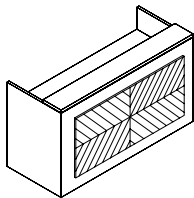

**Decorative Front Panel
Reverse Diamond Pattern**

DGFDP9630F	1 x 96 x 30	92.5	81	8	N/A	\$1612
DGFDP9030F	1 x 90 x 30	100	78	8	N/A	\$1509
DGFDP8430F	1 x 84 x 30	92.5	72	7	N/A	\$1410
DGFDP7230F	1 x 72 x 30	100	66	7	N/A	\$1207
DGFDP6030F	1 x 60 x 30	92.5	60	6	N/A	\$1008
DGFDP5430F	1 x 54 x 30	100	54	6	N/A	\$906
DGFDP4830F	1 x 48 x 30	100	48	5	N/A	\$806

Raised decorative front panel for a reception desk. Size should be 12" less than desk dimensions. **Factory installed**. Hardware included.

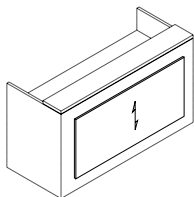

**Decorative Front Panel
Vertical Grain Pattern**

DGFDP9630V	1 x 96 x 30	92.5	81	8	N/A	\$1402
DGFDP9030V	1 x 90 x 30	100	78	8	N/A	\$1313
DGFDP8430V	1 x 84 x 30	92.5	72	7	N/A	\$1227
DGFDP7230V	1 x 72 x 30	100	66	7	N/A	\$1050
DGFDP6030V	1 x 60 x 30	92.5	60	6	N/A	\$876
DGFDP5430V	1 x 54 x 30	100	54	6	N/A	\$790
DGFDP4830V	1 x 48 x 30	100	48	5	N/A	\$699

Raised decorative front panel for a reception desk. Size should be 12" less than desk dimensions. **Factory installed**. Hardware included.

Required Specifications

Veneer Finish

lufton

global



GLOBAL is pleased to introduce the **LUFTON** wood veneer series. This contemporary collection features an all wood veneer construction with a variety of features that emphasize a modern approach to the private office.

1" worksurfaces include a choice of four ¼" hardwood edges to choose from – Flat (L10), Radius (L20), Fluted (L30) and Soft Tail (L40). A black 5mm PVC inlay between the worksurface and gable provides a striking visual detail. Drawers and storage items feature eight handle options to choose from (where applicable) – storage options are available in 29", 66" and 72" heights. Various models include different types of storage configurations.

New 23" height credenzas allow for different visual planes – combined with a spacer unit, worksurfaces can be supported over this credenza.

Above worksurface storage selections include overhead storage and hutches with or without pigeon-hole storage. Hutch doors are available in a choice of veneer or glass with an aluminum frame. Tackboards are offered in all fabric or with a built-in accessory rail for organizing folders, binders, CDs and more!



Features and Benefits

- Choice of eight handle options for every door/drawer that features handles.
- Modesty panel options include metal (in Black or Tungsten), veneer, and glass.
- Base upgrades to replace standard monopost on islands are available in four styles.
- Drawers are standard vinyl wrapped construction with black drawer slides and bottom.
- 75 lb. box – 150 lb. file drawer weight capacity with full height sides – pencil tray included in box drawer.
- Lateral file drawers can accommodate legal or letter documents.
- Box drawers mounted on ¾ extension premium ball bearing slides.
- Power/Data accessories are available to be factory installed on any LUFTON unit, including Boardroom Tables to meet all today's technological requirements.
- A full array of complementary Boardroom and Reception area furnishings are available to coordinate the entire office.

GENERAL INFORMATION

- LUFTON is a veneer desking system composed of hundreds of models, capable of furnishing executive suites, boardrooms and reception areas.
- 1" worksurfaces with 1/4" solid Wood Edge all around.
- 5MM Black PVC inlay between top and gables
- GM5P Grommet on all designated worksurfaces
- Global desking products are in compliance with stringent emission guidelines set out by the Greenguard Environmental Institute under the standards for low emitting products and materials. www.greenguard.org
- **Level 2 Certified**

Handles

- Handles are standard on most drawers/storage modules. Each handle is identified by letters "PL33", "PL34", "PLS7", "PLS8", "PL74", "PL75", "PL64" and "PL67". To specify a handle, please specify the code after the model number and veneer & laminate selections.

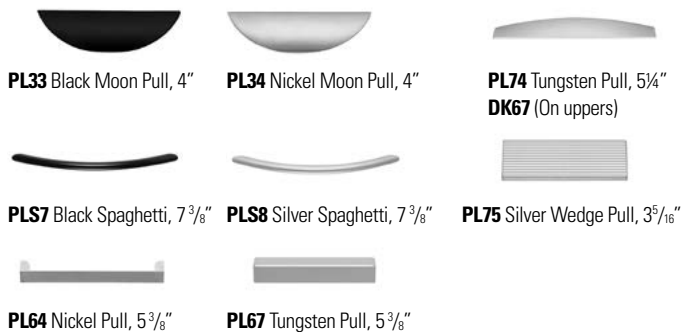

Edges

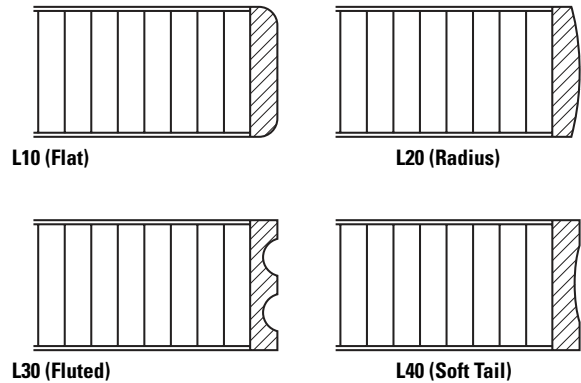

Grommets

- Standard grommet on all components is GM5P. Grommet is included with products where shown in line drawings in price book.
- Optional grommets may be ordered in standard worksurface locations (left, center or right). Order as **GM5PTL, GM5PTC or GM5PTR. ADD 69.00.**
- Grommet hole dimensions are 3.5" x 2". Specify **GM5PE** for **Black** or **GM5PK** for **Tungsten**.
- Color of grommet will be automatically coordinated with handle color where applicable

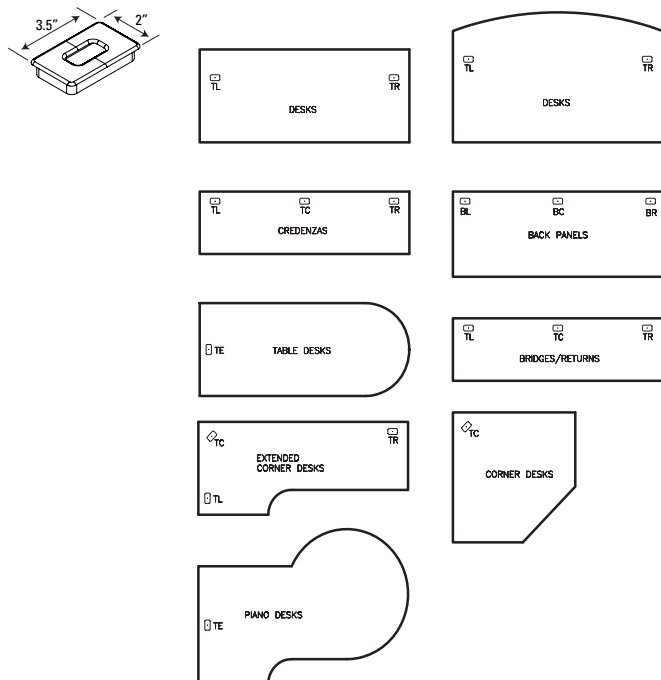

WORKSURFACE TOP & DRAWER/DOOR FRONTS, BODY FINISHES (INCLUDING PEDESTALS) - VENEER

Code	Finish	Veneer Type	Cut
AMW	Almond Cherry	Cherry	Flat Sliced
BAMC	Caramel Bamboo	Bamboo	Narrow
CAW	Cocoa Walnut	Walnut	Flat Sliced
CRW	Coral	White Oak	Rift
DCW	Dark Cherry	Cherry	Flat Sliced
EWV	Espresso Walnut	Walnut	Flat Sliced
EVV	Evening Oak	White Oak	Rift
GRW	Grey on Oak	White Oak	Rift
HAW	Hazelnut	Maple	Flat Sliced
SMW	Honey Maple	Maple	Flat Sliced
JAW	Java	White Oak	Rift
LTW	Latte Walnut	Walnut	Flat Sliced
MTW	Milestone	White Oak	Rift
MCW	Mocha	White Oak	Rift
MPW	Natural Maple	Maple	Flat Sliced
RCW	Red Cherry	Cherry	Flat Sliced
VNW	Vintage Cherry	Cherry	Flat Sliced
WLW	Walnut	Walnut	Flat Sliced
WCW	Warm Cherry	Cherry	Flat Sliced
WMW	White Maple	Maple	Flat Sliced

DOUBLE PEDESTAL DESKS

MODEL#

DIMENSIONS

FREIGHT CLASS

WT./LBS.

CUBIC FT.

LIST PRICE

- Can be ordered as a shell or with pedestals.
- Grommets are available as an option on Desks and most Credenzas.
- Hand of Rectangular Desk is determined by location of pedestal from user side.
- Hand of "D" Island is determined by outward orientation of conference end from user projection.

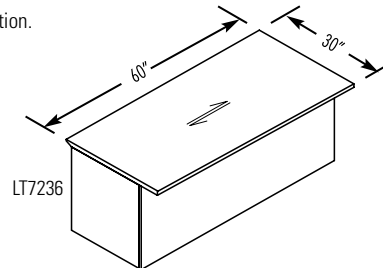
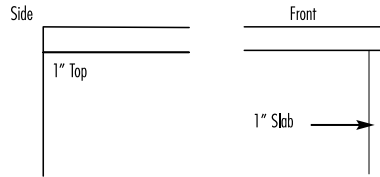
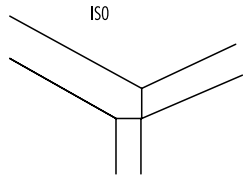

MODESTY PANEL CLEARANCE:

LT7236

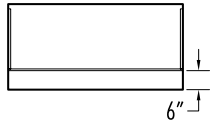

LT7230

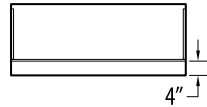

LMT7242

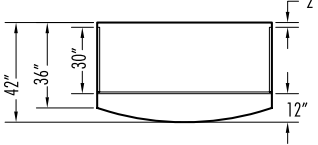

LMT7236

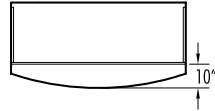

LISR7236D

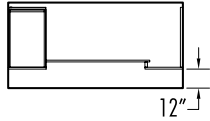

LISR7230D

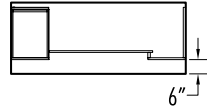

LDD7230

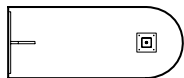

LDDBE7230

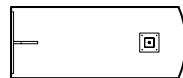

DESK MODESTY OPTIONS:

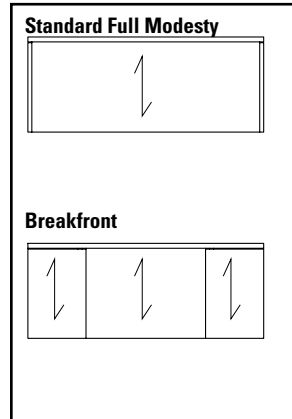

Breakfront Style - Modesty

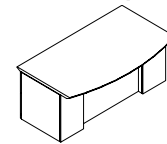

view from guest side

Recessed Front - Modesty

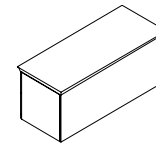

view from guest side

DOUBLE PEDESTAL DESKS - RECESSED FRONT MODESTY

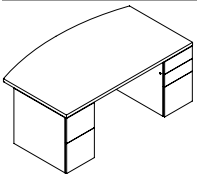

Double Pedestal Bow Top Desk

	D x W x H				
LMD8442ED	42 x 84 x 29	125	443	59	\$4701
LMD7842ED	42 x 78 x 29	125	412	55	\$4367
LMD7242ED	42 x 72 x 29	125	380	51	\$4029
LMD6636ED	36 x 66 x 29	125	240	40	\$3910

Standard with full to floor **file/file** pedestal on **left** and **box/box/file** pedestal on **right**. Bow top. Pedestals lock. One pencil tray. Refer to the Desks and Credenzas Notes Section above for overhang dimensions.

Required Specifications

Veneer Finish
Edge

Optional Specifications

Grommet

DOUBLE PEDESTAL DESKS - BREAKFRONT STYLE

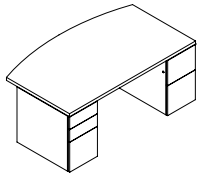

Double Pedestal Bow Top Desk

MODEL#	DIMENSIONS D x W x H	FREIGHT CLASS	WT/LBS.	CUBIC FT.	LIST PRICE
LMD8442DE	42 x 84 x 29	125	443	59	\$4701
LMD7842DE	42 x 78 x 29	125	412	55	\$4367
LMD7242DE	42 x 72 x 29	125	380	51	\$4029
LMD6636DE	36 x 66 x 29	125	240	40	\$3910

Standard with full to floor **box/box/file** pedestal on **left** and **file/file** pedestal on **right**. Bow top. Pedestals lock. One pencil tray. Refer to the Desks and Credenzas Notes Section on previous page for overhang dimensions.

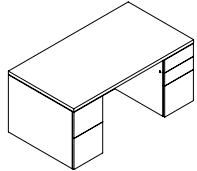

Double Pedestal Desk

LD8436ED	36 x 84 x 29	125	432	59	\$3996
LD7236ED	36 x 72 x 29	100	370	44	\$3426
LD7230ED	30 x 72 x 29	100	349	36	\$3376
LD6636ED	36 x 66 x 29	100	339	40	\$3376
LD6630ED	30 x 66 x 29	100	320	33	\$3321

Standard with full to floor **file/file** pedestal on **left** and **box/box/file** pedestal on **right**. Pedestals lock. Refer to the Desks and Credenzas Notes Section on previous page for overhang dimensions.

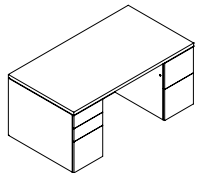

Double Pedestal Desk

LD8436DE	36 x 84 x 29	125	432	59	\$3996
LD7236DE	36 x 72 x 29	100	370	44	\$3426
LD7230DE	30 x 72 x 29	100	349	36	\$3376
LD6636DE	36 x 66 x 29	100	339	40	\$3376
LD6630DE	30 x 66 x 29	100	320	33	\$3321

Standard with full to floor **box/box/file** pedestal on **left** and **file/file** pedestal on **right**. Pedestals lock. Refer to the Desks and Credenzas Notes Section on previous page for overhang dimensions.

DOUBLE PEDESTAL DESKS - BREAKFRONT STYLE

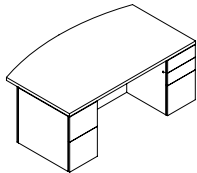

**Double Pedestal Bow Top Desk
Breakfront Style**

LMID8442ED	42 x 84 x 29	125	443	59	\$5259
LMID7842ED	42 x 78 x 29	125	412	55	\$4893
LMID7242ED	42 x 72 x 29	125	380	51	\$4524
LMID6636ED	36 x 66 x 29	125	240	40	\$4354

Standard with full to floor **file/file** pedestal on **left** and **box/box/file** pedestal on **right**. Bow top. Pedestals lock. One pencil tray. Refer to the Desks and Credenzas Notes Section on previous page for overhang dimensions.

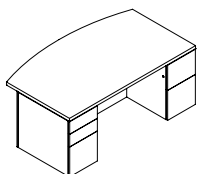

**Double Pedestal Bow Top Desk
Breakfront Style**

LMID8442DE	42 x 84 x 29	125	443	59	\$5259
LMID7842DE	42 x 78 x 29	125	412	55	\$4893
LMID7242DE	42 x 72 x 29	125	380	51	\$4524
LMID6636DE	36 x 66 x 29	125	240	40	\$4354

Standard with full to floor **box/box/file** pedestal on **left** and **file/file** pedestal on **right**. Bow top. Pedestals lock. One pencil tray. Refer to the Desks and Credenzas Notes Section on previous page for overhang dimensions.

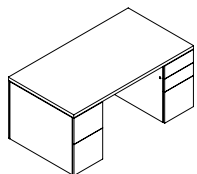

Double Pedestal Desk, Breakfront Style

LID8436ED	36 x 84 x 29	125	432	59	\$4126
LID7236ED	36 x 72 x 29	100	370	44	\$3830
LID7230ED	30 x 72 x 29	100	349	36	\$3771
LID6636ED	36 x 66 x 29	100	339	40	\$3771
LID6630ED	30 x 66 x 29	100	320	33	\$3713

Standard with full to floor **file/file** pedestal on **left** and **box/box/file** pedestal on **right**. Pedestals lock. Refer to the Desks and Credenzas Notes Section on previous page for overhang dimensions.

Required Specifications

Veneer Finish
Edge

Optional Specifications

Grommet

DOUBLE PEDESTAL DESKS - BREAKFRONT STYLE

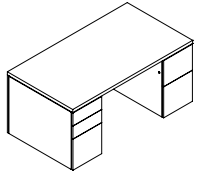

Double Pedestal Desk, Breakfront Style

MODEL#	DIMENSIONS D x W x H	FREIGHT CLASS	WT/LBS.	CUBIC FT.	LIST PRICE
LID8436DE	36 x 84 x 29	125	432	59	\$4126
LID7236DE	36 x 72 x 29	100	370	44	\$3830
LID7230DE	30 x 72 x 29	100	349	36	\$3771
LID6636DE	36 x 66 x 29	100	339	40	\$3771
LID6630DE	30 x 66 x 29	100	320	33	\$3713

Standard with full to floor **box/box/file** pedestal on **left** and **file/file** pedestal on **right**. Pedestals lock. Refer to the Desks and Credenzas Notes Section on page 84 for overhang dimensions.

SINGLE PEDESTAL DESKS

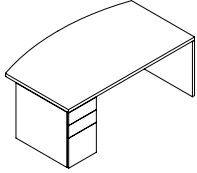

Single Pedestal Bow Top Desk - LEFT

LMSL8442D	42 x 84 x 29	125	432	59	\$4501
LMSL7842D	42 x 78 x 29	125	401	55	\$4178
LMSL7242D	42 x 72 x 29	125	370	51	\$3862
LMSL6636D	36 x 66 x 29	150	230	40	\$3713

Standard with full to floor **box/box/file** pedestal on **left**. Bow top. Pedestal locks. Refer to the Desks and Credenzas Notes Section on page 84 for overhang dimensions.

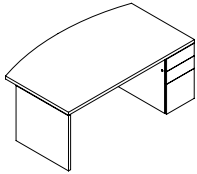

Single Pedestal Bow Top Desk - RIGHT

LMSR8442D	42 x 84 x 29	125	432	59	\$4501
LMSR7842D	42 x 78 x 29	125	401	55	\$4178
LMSR7242D	42 x 72 x 29	125	370	51	\$3862
LMSR6636D	36 x 66 x 29	150	230	40	\$3713

Standard with full to floor **box/box/file** pedestal on **right**. Bow top. Pedestal locks. Refer to the Desks and Credenzas Notes Section on page 84 for overhang dimensions.

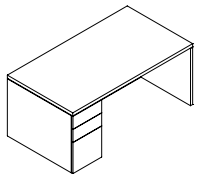

Single Pedestal Desk - LEFT

LSL8436D	42 x 84 x 29	125	463	59	\$3049
LSL7236D	36 x 72 x 29	125	340	44	\$2613
LSL7230D	30 x 72 x 29	125	283	36	\$2496
LSL6636D	36 x 66 x 29	125	312	40	\$2496
LSL6630D	30 x 66 x 29	100	295	33	\$2384

Standard with full to floor **box/box/file** pedestal on **left**. Pedestal locks. Refer to the Desks and Credenzas Notes Section on page 84 for overhang dimensions.

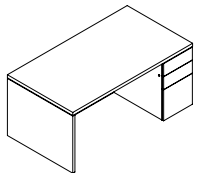

Single Pedestal Desk - RIGHT

LSR8436D	36 x 84 x 29	125	463	59	\$3049
LSR7236D	36 x 72 x 29	125	340	44	\$2613
LSR7230D	30 x 72 x 29	125	283	36	\$2496
LSR6636D	36 x 66 x 29	125	312	40	\$2496
LSR6630D	30 x 66 x 29	100	295	33	\$2384

Standard with full to floor **box/box/file** pedestal on **right**. Pedestal locks. Refer to the Desks and Credenzas Notes Section on page 84 for overhang dimensions.

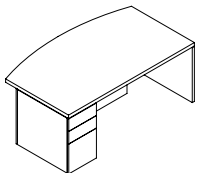

**Single Pedestal Bow Top Desk - LEFT
Breakfront Style**

LMISL8442D	42 x 84 x 29	125	432	59	\$4593
LMISL7842D	42 x 78 x 29	125	401	55	\$4271
LMISL7242D	42 x 72 x 29	125	370	51	\$3956
LMISL6636D	36 x 66 x 29	150	230	40	\$3771

Standard with full to floor **box/box/file** pedestal on **left**. Bow top. Pedestal locks. Refer to the Desks and Credenzas Notes Section on page 84 for overhang dimensions.

Required Specifications

Veneer Finish
Edge

Optional Specifications

Grommet

SINGLE PEDESTAL DESKS - BREAKFRONT STYLE

MODEL# DIMENSIONS FREIGHT CLASS WT/LBS. CUBIC FT. LIST PRICE

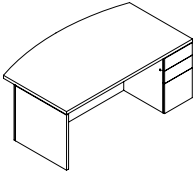

Single Pedestal Bow Top Desk - RIGHT Breakfront Style

D x W x H						
LMISR8442D	42 x 84 x 29	125	432	59	\$4593	
LMISR7842D	42 x 78 x 29	125	401	55	\$4271	
LMISR7242D	42 x 72 x 29	125	370	51	\$3956	
LMISR6636D	36 x 66 x 29	150	230	40	\$3771	

Standard with full to floor **box/box/file** pedestal on **right**. Bow top. Pedestal locks. Refer to the Desks and Credenzas Notes Section on page 84 for overhang dimensions.

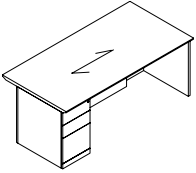

Single Pedestal Desk - LEFT Breakfront Style

LISL8436D	36 x 84 x 29	125	463	59	\$4007
LISL7236D	36 x 72 x 29	125	340	44	\$3413
LISL7230D	30 x 72 x 29	125	283	36	\$2809
LISL6636D	36 x 66 x 29	125	312	40	\$2809
LISL6630D	30 x 66 x 29	100	295	33	\$2682

Standard with full to floor **box/box/file** pedestal on **left**. Pedestal locks. Refer to the Desks and Credenzas Notes Section on page 84 for overhang dimensions.

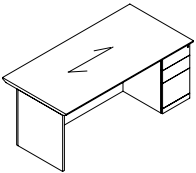

Single Pedestal Desk - RIGHT Breakfront Style

LISR8436D	42 x 84 x 29	125	463	59	\$4007
LISR7236D	36 x 72 x 29	125	340	44	\$3413
LISR7230D	30 x 72 x 29	125	283	36	\$2809
LISR6636D	36 x 66 x 29	125	312	40	\$2809
LISR6630D	30 x 66 x 29	100	295	33	\$2682

Standard with full to floor **box/box/file** pedestal on **right**. Pedestal locks. Refer to the Desks and Credenzas Notes Section on page 84 for overhang dimensions.

DESK SHELLS

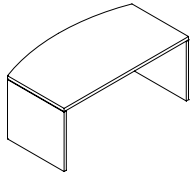

Bow Top Desk Shell

LMT8442	42 x 84 x 29	125	380	59	\$3459
LMT7842	42 x 78 x 29	125	353	55	\$3208
LMT7242	42 x 72 x 29	125	331	51	\$2969
LMT6636	36 x 66 x 29	125	287	40	\$2827

Bow top and recessed modesty panel. Refer to the Desks and Credenzas Notes Section on page 84 for overhang dimensions.

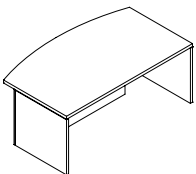

Bow Top Desk Shell, Breakfront Style

LMIT8442	42 x 84 x 29	125	380	59	\$3553
LMIT7842	42 x 78 x 29	125	353	55	\$3350
LMIT7242	42 x 72 x 29	125	331	51	\$3146
LMIT6636	36 x 66 x 29	125	287	40	\$3031

Bow top and recessed modesty panel. Refer to the Desks and Credenzas Notes Section on page 84 for overhang dimensions.

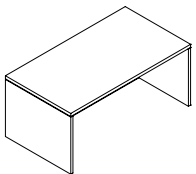

Desk Shell

LT8436	36 x 84 x 29	150	362	51	\$2486
LT7236	36 x 72 x 29	125	315	44	\$2366
LT7230	30 x 72 x 29	125	271	36	\$2231
LT6636	36 x 66 x 29	100	271	40	\$2231
LT6630	30 x 66 x 29	100	265	33	\$2090

Recessed modesty panel. Refer to the Desks and Credenzas Notes Section on page 84 for overhang dimensions.

Required Specifications

Veneer Finish
Edge

Optional Specifications

Grommet

RETURNS

- An Executive Return is used to attach to a Single Pedestal Desk, Single Pedestal Credenza, Desk Shell or Credenza Shell.
- Grommets are available as an option.
- Hand of Executive Return is determined by location of full end panel from user side.
- Hand of Desk or Credenza is determined by location of pedestal from user side.
- To remove cross grain veneer pattern on top, delete suffix "CG" from the model number. Available as a special - no upcharge.

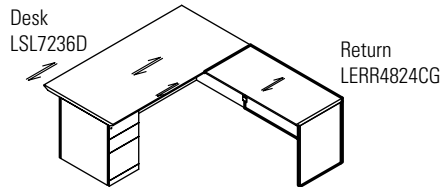
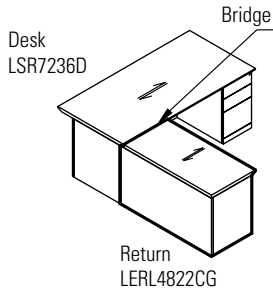

RETURNS

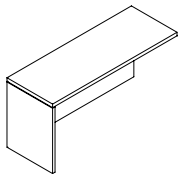

Flush Return - LEFT 24" Deep

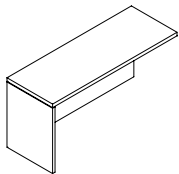

Flush Return - LEFT 20" Deep

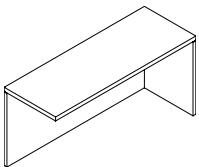

Flush Return - RIGHT 24" Deep

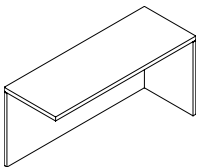

Flush Return - RIGHT 20" Deep

MODEL#

DIMENSIONS

FREIGHT CLASS

WT/LBS.

CUBIC FT.

LIST PRICE

D x W x H

LERL7224CG	24 x 72 x 29	150	135	29	\$1814
LERL6624CG	24 x 66 x 29	150	127	27	\$1694
LERL6024CG	24 x 60 x 29	150	120	24	\$1570
LERL5424CG	24 x 54 x 29	150	112	22	\$1451
LERL4824CG	24 x 48 x 29	150	105	19	\$1331
LERL4224CG	24 x 42 x 29	150	97	17	\$1207

Return has **no pedestal**. For use with right handed single pedestal desks, credenzas, desk shells, credenza shells, "D" islands or "P" islands.

LERL7220CG	20 x 72 x 29	150	130	27	\$1316
LERL6620CG	20 x 66 x 29	150	122	24	\$1207
LERL6020CG	20 x 60 x 29	150	115	22	\$1098
LERL5420CG	20 x 54 x 29	150	105	20	\$989
LERL4820CG	20 x 48 x 29	150	100	18	\$880
LERL4220CG	20 x 42 x 29	150	90	16	\$771

Return has **no pedestal**. For use with right handed single pedestal desks, credenzas, desk shells, credenza shells, "D" islands or "P" islands.

LERR7224CG	24 x 72 x 29	150	135	29	\$1814
LERR6624CG	24 x 66 x 29	150	127	27	\$1694
LERR6024CG	24 x 60 x 29	150	120	24	\$1570
LERR5424CG	24 x 54 x 29	150	112	22	\$1451
LERR4824CG	24 x 48 x 29	150	105	19	\$1331
LERR4224CG	24 x 42 x 29	150	97	17	\$1207

Return has **no pedestal**. For use with left handed single pedestal desks, credenzas, desk shells, credenza shells, "D" islands or "P" islands.

LERR7220CG	20 x 72 x 29	150	130	27	\$1316
LERR6620CG	20 x 66 x 29	150	122	24	\$1207
LERR6020CG	20 x 60 x 29	150	115	22	\$1098
LERR5420CG	20 x 54 x 29	150	105	20	\$989
LERR4820CG	20 x 48 x 29	150	100	18	\$880
LERR4220CG	20 x 42 x 29	150	90	16	\$771

Return has **no pedestal**. For use with left handed single pedestal desks, credenzas, desk shells, credenza shells, "D" islands or "P" islands.

Required Specifications

Veneer Finish
Edge

Optional Specifications

Grommet

RETURNS MODEL# DIMENSIONS FREIGHT CLASS WT/LBS. CUBIC FT. LIST PRICE

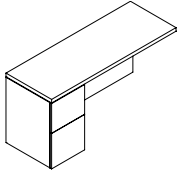

Flush Return - LEFT 24" Deep

D x W x H						
LERL7224ECG	24 x 72 x 29	100	250	29		\$3026
LERL6624ECG	24 x 66 x 29	100	236	27		\$2925
LERL6024ECG	24 x 60 x 29	100	227	24		\$2686
LERL5424ECG	24 x 54 x 29	100	205	22		\$2598
LERL4824ECG	24 x 48 x 29	100	185	19		\$2341
LERL4224ECG	24 x 42 x 29	92.5	178	17		\$2264

Return has **file/file** pedestal on the **left**. Pedestal locks. For use with right handed single pedestal desks, credenzas, desk shells, credenza shells, "D" islands or "P" islands.

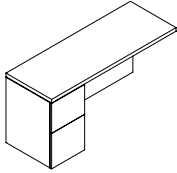

Flush Return - LEFT 20" Deep

LERL7220ECG	20 x 72 x 29	100	240	29		\$2347
LERL6620ECG	20 x 66 x 29	100	231	27		\$2261
LERL6020ECG	20 x 60 x 29	100	222	24		\$2053
LERL5420ECG	20 x 54 x 29	100	200	22		\$1981
LERL4820ECG	20 x 48 x 29	100	180	18		\$1763
LERL4220ECG	20 x 42 x 29	92.5	173	16		\$1694

Return has **file/file** pedestal on the **left**. Pedestal locks. For use with right handed single pedestal desks, credenzas, desk shells, credenza shells, "D" islands or "P" islands.

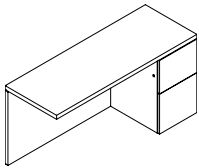

Flush Return - RIGHT 24" Deep

LERR7224ECG	24 x 72 x 29	100	250	29		\$3026
LERR6624ECG	24 x 66 x 29	100	236	27		\$2925
LERR6024ECG	24 x 60 x 29	100	227	24		\$2686
LERR5424ECG	24 x 54 x 29	100	205	22		\$2598
LERR4824ECG	24 x 48 x 29	100	185	19		\$2341
LERR4224ECG	24 x 42 x 29	92.5	178	17		\$2264

Return has **file/file** pedestal on the **right**. Pedestal locks. For use with left handed single pedestal desks, credenzas, desk shells, credenza shells, "D" islands or "P" islands.

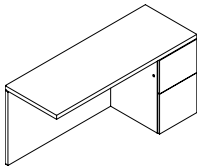

Flush Return - RIGHT 20" Deep

LERR7220ECG	20 x 72 x 29	100	240	29		\$2347
LERR6620ECG	20 x 66 x 29	100	231	27		\$2261
LERR6020ECG	20 x 60 x 29	100	222	24		\$2053
LERR5420ECG	20 x 54 x 29	100	200	22		\$1981
LERR4820ECG	20 x 48 x 29	100	180	18		\$1763
LERR4220ECG	20 x 42 x 29	92.5	173	16		\$1694

Return has **file/file** pedestal on the **right**. Pedestal locks. For use with left handed single pedestal desks, credenzas, desk shells, credenza shells, "D" islands or "P" islands.

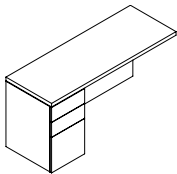

Flush Return - LEFT 24" Deep

LERL7224DCG	24 x 72 x 29	100	250	29		\$3026
LERL6624DCG	24 x 66 x 29	100	236	27		\$2925
LERL6024DCG	24 x 60 x 29	100	227	24		\$2686
LERL5424DCG	24 x 54 x 29	100	205	22		\$2598
LERL4824DCG	24 x 48 x 29	100	185	19		\$2341
LERL4224DCG	24 x 42 x 29	92.5	178	17		\$2264

Return has **box/box/file** pedestal on the **left**. Pedestal locks. For use with right handed single pedestal desks, credenzas, desk shells, credenza shells, "D" islands or "P" islands.

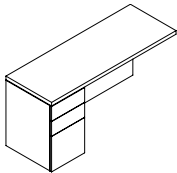

Flush Return - LEFT 20" Deep

LERL7220DCG	20 x 72 x 29	100	240	27		\$2347
LERL6620DCG	20 x 66 x 29	100	231	24		\$2261
LERL6020DCG	20 x 60 x 29	100	222	22		\$2053
LERL5420DCG	20 x 54 x 29	100	200	20		\$1981
LERL4820DCG	20 x 48 x 29	100	180	18		\$1763
LERL4220DCG	20 x 42 x 29	92.5	173	16		\$1694

Return has **box/box/file** pedestal on the **left**. Pedestal locks. For use with right handed single pedestal desks, credenzas, desk shells, credenza shells, "D" islands or "P" islands.

Required Specifications

Veneer Finish
Edge

Optional Specifications

Grommet

RETURNS

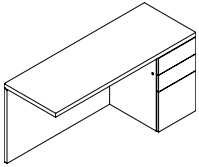

Flush Return - RIGHT 24" Deep

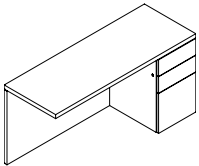

Flush Return - RIGHT 20" Deep

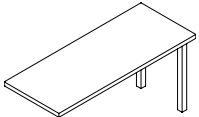

Return

MODEL#	DIMENSIONS	FREIGHT CLASS	WT/LBS.	CUBIC FT.	LIST PRICE
--------	------------	---------------	---------	-----------	------------

D x W x H

LERR7224DCG	24 x 72 x 29	100	250	29	\$3026
LERR6624DCG	24 x 66 x 29	100	236	27	\$2925
LERR6024DCG	24 x 60 x 29	100	227	24	\$2686
LERR5424DCG	24 x 54 x 29	100	205	22	\$2598
LERR4824DCG	24 x 48 x 29	100	185	19	\$2341
LERR4224DCG	24 x 42 x 29	92.5	178	17	\$2264

Return has **box/box/file** pedestal on the **right**. Pedestal locks. For use with left handed single pedestal desks, credenzas, desk shells, credenza shells, "D" islands or "P" islands.

LERR7220DCG	20 x 72 x 29	100	240	27	\$2347
LERR6620DCG	20 x 66 x 29	100	231	24	\$2261
LERR6020DCG	20 x 60 x 29	100	222	22	\$2053
LERR5420DCG	20 x 54 x 29	100	200	20	\$1981
LERR4820DCG	20 x 48 x 29	100	180	18	\$1763
LERR4220DCG	20 x 42 x 29	92.5	173	16	\$1694

Return has **box/box/file** pedestal on the **right**. Pedestal locks. For use with left handed single pedestal desks, credenzas, desk shells, credenza shells, "D" islands or "P" islands.

LR8430CG	30 x 84 x 29	150	130	29	\$1316
LR7230CG	30 x 72 x 29	150	122	27	\$1163
LR6630CG	30 x 66 x 29	150	115	24	\$1094
LR6030CG	30 x 60 x 29	150	105	22	\$1018

Return has **no pedestal**. For use with single pedestal desks, credenzas, desk shells, credenza shells, "D" islands or "P" islands.

BRIDGES - EXECUTIVE

- An Executive Bridge is used to connect a Desk to a Credenza.
- Not to be used with Corner Components or Piano Desks,
- Three Modesty Panel options - Full Modesty, 8" Modesty and No Modesty (Flush Bridge Top).
- Modesty panel flush with end panels of Desk and Credenza.
- Includes GM1 grommet in the top center position.
- Both connecting sides of executive bridges feature a reverse profile edge

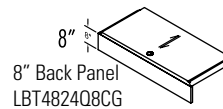
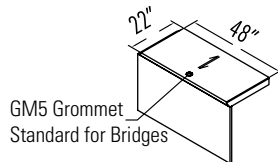
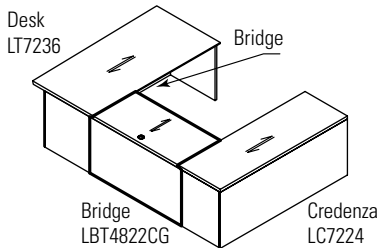

Required Specifications

Veneer Finish
Edge

Optional Specifications

Grommet

BRIDGES - LINKING

MODEL#

DIMENSIONS

FREIGHT CLASS

WT/LBS.

CUBIC FT.

LIST PRICE

D x W x H

- A Linking Bridge is used to connect Corner Components to a Single Pedestal Desk, Single Pedestal Credenza, Desk Shell or Credenza Shell.
- Two Modesty Panel options - Full Modesty and 8" Modesty.
- Includes GM1 grommet in the top center position.
- Hand of Linking Bridge is determined by location of half end panel from user side.
- Linking Bridges are handed **left and right** (Handedness is determined by connecting side with the self edge). The opposite connecting side features a revers profile edge.

Supporting Slab Joining Structure

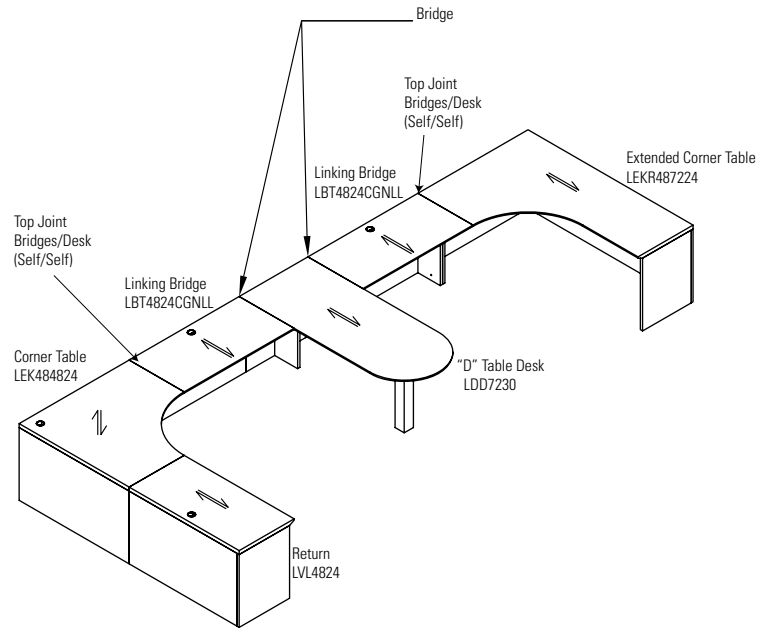
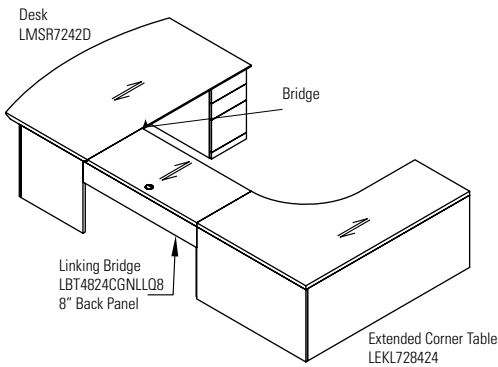
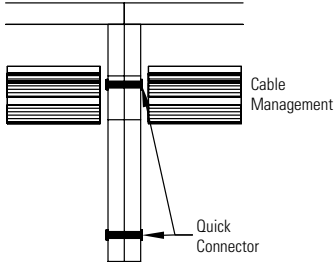

BRIDGES

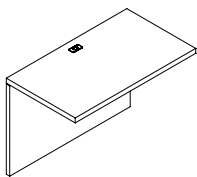

Flush Bridge

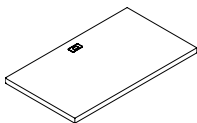

Flush Bridge Top

LBT6024CG	24 x 60 x 29	85	144	10	\$1280
LBT5424CG	24 x 54 x 29	85	129	9	\$1152
LBT4824CG	24 x 48 x 29	70	120	8	\$1026
LBT4224CG	24 x 42 x 29	70	105	7	\$898
LBT6020CG	20 x 60 x 29	70	131	8	\$1051
LBT5420CG	20 x 54 x 29	85	118	8	\$946
LBT4820CG	20 x 48 x 29	70	110	7	\$840
LBT4220CG	20 x 42 x 29	70	96	6	\$720

Top surface, back panel and hardware to create a "U" configuration with a single pedestal desk or credenza. **Cannot be used with corners.** Grommet in worksurface. Shipped RTA (ready to assemble).

- If linking to bookcase or open storage, add **/S** to end of model number

LBT5424TCG	24 x 54 x --	85	129	9	\$901
LBT4824TCG	24 x 48 x --	70	120	8	\$811
LBT4224TCG	24 x 42 x --	70	105	7	\$713
LBT5420TCG	20 x 54 x --	85	118	8	\$662
LBT4820TCG	20 x 48 x --	70	110	7	\$590
LBT4220TCG	20 x 42 x --	70	96	6	\$502

Top surface only to create a "U" configuration with a single pedestal desk or credenza. **Cannot be used with corners.** Grommet in worksurface. Shipped RTA (ready to assemble).

- If linking to bookcase or open storage, add **/S** to end of model number

Required Specifications

Veneer Finish
Edge

Optional Specifications

Grommet

BRIDGES

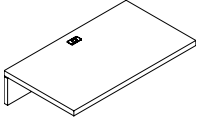

Flush Bridge Top, 8" Modesty Panel

MODEL#	DIMENSIONS D x W x H	FREIGHT CLASS	WT/LBS.	CUBIC FT.	LIST PRICE
LBT6024Q8CG	24 x 60 x --	85	144	10	\$1149
LBT5424Q8CG	24 x 54 x --	85	129	9	\$1040
LBT4824Q8CG	24 x 48 x --	70	120	8	\$924
LBT4224Q8CG	24 x 42 x --	70	105	7	\$807
LBT6020Q8CG	20 x 60 x --	70	131	8	\$946
LBT5420Q8CG	20 x 54 x --	85	118	8	\$850
LBT4820Q8CG	20 x 48 x --	70	110	7	\$756
LBT4220Q8CG	20 x 42 x --	70	96	6	\$647

Top surface with 8" modesty panel for utility access. Create a "U" configuration with a single pedestal desk or credenza. **Cannot be used with corners.** Grommet in worksurface. Shipped RTA (ready to assemble).

- If linking to bookcase or open storage, add **/S** to end of model number

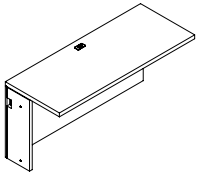

Linking Bridge - LEFT

LBT6024NLLCG	24 x 60 x 29	125	145	24	\$1269
LBT5424NLLCG	24 x 54 x 29	150	131	22	\$1141
LBT4824NLLCG	24 x 48 x 29	125	116	19	\$1015
LBT4224NLLCG	24 x 42 x 29	125	102	17	\$822
LBT3624NLLCG	24 x 36 x 29	150	87	15	\$749
LBT3024NLLCG	24 x 30 x 29	125	73	12	\$727
LBT6020NLLCG	22 x 60 x 29	150	131	22	\$1152
LBT5420NLLCG	22 x 54 x 29	150	118	20	\$1036
LBT4820NLLCG	22 x 48 x 29	125	110	18	\$924
LBT4220NLLCG	22 x 42 x 29	150	95	16	\$749
LBT3620NLLCG	22 x 36 x 29	125	80	13	\$680
LBT3020NLLCG	22 x 30 x 29	150	65	11	\$662

Top surface, back panel and hardware. **Left side** connects to a 5-Sided Corner, Extended Corner or Connectable Table. Right side connects to a single pedestal desk or credenza, "D" island, Boat shaped island, "P" island and Delta island with a "T" base. Grommet in worksurface.

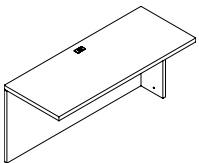

Linking Bridge - RIGHT

LBT6024NLR CG	24 x 60 x 29	125	145	24	\$1269
LBT5424NLR CG	24 x 54 x 29	150	131	22	\$1141
LBT4824NLR CG	24 x 48 x 29	125	116	19	\$1015
LBT4224NLR CG	24 x 42 x 29	125	102	17	\$822
LBT3624NLR CG	24 x 36 x 29	150	87	15	\$749
LBT3024NLR CG	24 x 30 x 29	125	73	12	\$727
LBT6020NLR CG	22 x 60 x 29	150	131	22	\$1152
LBT5420NLR CG	22 x 54 x 29	150	118	20	\$1036
LBT4820NLR CG	22 x 48 x 29	125	110	18	\$924
LBT4220NLR CG	22 x 42 x 29	150	95	16	\$749
LBT3620NLR CG	22 x 36 x 29	125	80	13	\$680
LBT3020NLR CG	22 x 30 x 29	150	65	11	\$662

Top surface, back panel and hardware. **Right side** connects to a 5-Sided Corner, Extended Corner or Connectable Table. Right side connects to a single pedestal desk or credenza, "D" island, Boat shaped island, "P" island and Delta island with a "T" base. Grommet in worksurface.

Required Specifications

Veneer Finish
Edge

Optional Specifications

Grommet

BRIDGES

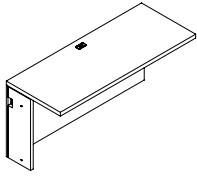

Linking Bridge, 8" Modesty Panel - LEFT

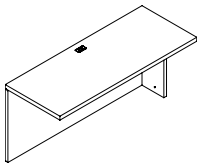

Linking Bridge, 8" Modesty Panel - RIGHT

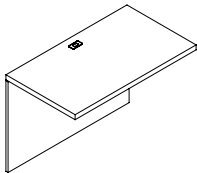

Bridge - Hinged Modesty

MODEL# DIMENSIONS FREIGHT CLASS WT/LBS. CUBIC FT. LIST PRICE

D x W x H

LBT6024NLLQ8CG	24 x 60 x 29	125	145	24	\$1400
LBT5424NLLQ8CG	24 x 54 x 29	150	131	22	\$1258
LBT4824NLLQ8CG	24 x 48 x 29	125	116	19	\$1105
LBT4224NLLQ8CG	24 x 42 x 29	125	102	17	\$981
LBT3624NLLQ8CG	24 x 36 x 29	150	87	15	\$811
LBT3024NLLQ8CG	24 x 30 x 29	125	73	12	\$793

LBT6020NLLQ8CG	20 x 60 x 29	150	131	22	\$1036
LBT5420NLLQ8CG	20 x 54 x 29	150	118	20	\$935
LBT4820NLLQ8CG	20 x 48 x 29	125	110	18	\$833
LBT4220NLLQ8CG	20 x 42 x 29	150	95	16	\$673
LBT3620NLLQ8CG	20 x 36 x 29	125	80	13	\$611
LBT3020NLLQ8CG	20 x 30 x 29	150	65	11	\$601

Top surface with 8" modesty panel for utility access and hardware. **Left side** connects to a 5-Sided Corner, Extended Corner or Connectable Table. Right side connects to a single pedestal desk or credenza, "D" island, Boat shaped island, "P" island and Delta island with a "T" base. Grommet in worksurface. Shipped RTA (ready to assemble).

LBT6024NLRQ8CG	24 x 60 x 29	125	145	24	\$1400
LBT5424NLRQ8CG	24 x 54 x 29	150	131	22	\$1258
LBT4824NLRQ8CG	24 x 48 x 29	125	116	19	\$1105
LBT4224NLRQ8CG	24 x 42 x 29	125	102	17	\$981
LBT3624NLRQ8CG	24 x 36 x 29	150	87	15	\$811
LBT3024NLRQ8CG	24 x 30 x 29	125	73	12	\$793

LBT6020NLRQ8CG	20 x 60 x 29	150	131	22	\$1036
LBT5420NLRQ8CG	20 x 54 x 29	150	118	20	\$935
LBT4820NLRQ8CG	20 x 48 x 29	125	110	18	\$833
LBT4220NLRQ8CG	20 x 42 x 29	150	95	16	\$673
LBT3620NLRQ8CG	20 x 36 x 29	125	80	13	\$611
LBT3020NLRQ8CG	20 x 30 x 29	150	65	11	\$601

Top surface with 8" modesty panel for utility access and hardware. **Right side** connects to a 5-Sided Corner, Extended Corner or Connectable Table. Right side connects to a single pedestal desk or credenza, "D" island, Boat shaped island, "P" island and Delta island with a "T" base. Grommet in worksurface. Shipped RTA (ready to assemble).

LHBT6024CG	24 x 60 x 29	85	144	10	\$1280
LHBT5424CG	24 x 54 x 29	85	129	9	\$1152
LHBT4824CG	24 x 48 x 29	70	120	8	\$1026
LHBT4224CG	24 x 42 x 29	70	105	7	\$898

LHBT6020CG	20 x 60 x 29	70	131	8	\$1051
LHBT5420CG	20 x 54 x 29	85	118	8	\$946
LHBT4820CG	20 x 48 x 29	70	110	7	\$840
LHBT4220CG	20 x 42 x 29	70	96	6	\$720

Executive Bridge Top and **Hinged Back Panel** to create a "U" configuration with a single pedestal desk or credenza. **Cannot be used with corners.** Grommet in worksurface. Shipped RTA (ready to assemble).

Required Specifications

Veneer Finish
Edge

Optional Specifications

Grommet

CREDENZAS

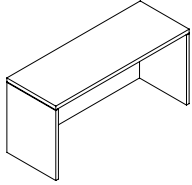

Credenza Shell

MODEL#	DIMENSIONS	FREIGHT CLASS	WT/LBS.	CUBIC FT.	LIST PRICE
--------	------------	---------------	---------	-----------	------------

D x W x H

LC10824	24 x 108 x 29	125	348	44	\$2871
LC10224	24 x 102 x 29	100	329	41	\$2736
LC9624	24 x 96 x 29	125	309	39	\$2591
LC9024	24 x 90 x 29	100	290	36	\$2456
LC8424	24 x 84 x 29	125	271	34	\$2318
LC7824	24 x 78 x 29	100	251	31	\$2173
LC7224	24 x 72 x 29	100	232	29	\$2039
LC6624	24 x 66 x 29	125	213	27	\$1973
LC6024	24 x 60 x 29	100	193	24	\$1828

LC10820	22 x 108 x 29	100	309	36	\$2290
LC10220	22 x 102 x 29	100	291	34	\$2170
LC9620	22 x 96 x 29	100	273	32	\$2046
LC9020	22 x 90 x 29	100	255	30	\$1922
LC8420	22 x 84 x 29	100	237	28	\$1802
LC7820	22 x 78 x 29	100	219	26	\$1679
LC7220	22 x 72 x 29	100	206	24	\$1556
LC6620	22 x 66 x 29	100	188	22	\$1501
LC6020	22 x 60 x 29	100	169	20	\$1374

Standard with **no pedestals**. Flush full modesty panel. 96" w and larger includes a center support leg. If using storage component shells underneath to support the worksurface, **no more than 72" may be left unsupported**.

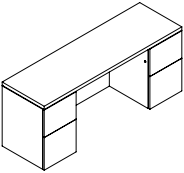

Kneespace Credenza

LCK8424EE	24 x 84 x 29	92.5	348	34	\$4498
LCK7824EE	24 x 78 x 29	92.5	319	31	\$4204
LCK7224EE	24 x 72 x 29	100	280	29	\$3910
LCK6624EE	24 x 66 x 29	100	261	27	\$3855
LCK6024EE	24 x 60 x 29	100	238	24	\$3611

LCK8420EE	20 x 84 x 29	92.5	320	34	\$3986
LCK7820EE	20 x 78 x 29	92.5	298	31	\$3724
LCK7220EE	20 x 72 x 29	92.5	280	29	\$3466
LCK6620EE	20 x 66 x 29	92.5	257	27	\$3208
LCK6020EE	20 x 60 x 29	92.5	233	24	\$2951

Standard with full to floor **file/file** pedestals on **left and right**. **Center is open** Pedestals lock.

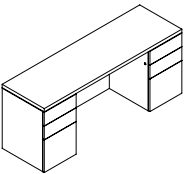

Kneespace Credenza

LCK8424DD	24 x 84 x 29	92.5	348	34	\$4498
LCK7824DD	24 x 78 x 29	92.5	319	31	\$4204
LCK7224DD	24 x 72 x 29	100	280	29	\$3910
LCK6624DD	24 x 66 x 29	100	261	27	\$3855
LCK6024DD	24 x 60 x 29	100	238	24	\$3611

LCK8420DD	20 x 84 x 29	92.5	307	28	\$3986
LCK7820DD	20 x 78 x 29	92.5	285	26	\$3724
LCK7220DD	20 x 72 x 29	92.5	267	24	\$3466
LCK6620DD	20 x 66 x 29	92.5	244	22	\$3208
LCK6020DD	20 x 60 x 29	92.5	220	20	\$2951

Standard with full to floor **box/box/file** pedestals on **left and right**. **Center is open** Pedestals lock.

Required Specifications

Veneer Finish
Edge

Optional Specifications

Grommet

CREDENZAS

MODEL# DIMENSIONS FREIGHT CLASS WT/LBS. CUBIC FT. LIST PRICE

D x W x H

LCK8424ED	24 x 84 x 29	92.5	348	34	\$4498
LCK7824ED	24 x 78 x 29	92.5	319	31	\$4204
LCK7224ED	24 x 72 x 29	100	280	29	\$3910
LCK6624ED	24 x 66 x 29	100	261	27	\$3855
LCK6024ED	24 x 60 x 29	100	238	24	\$3611

LCK8420ED	20 x 84 x 29	92.5	307	28	\$3986
LCK7820ED	20 x 78 x 29	92.5	285	26	\$3724
LCK7220ED	20 x 72 x 29	92.5	267	24	\$3466
LCK6620ED	20 x 66 x 29	92.5	244	22	\$3208
LCK6020ED	20 x 60 x 29	92.5	220	20	\$2951

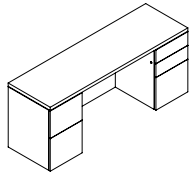

Kneespace Credenza

Standard with full to floor **file/file** pedestal on **left** and **box/box/file** pedestal on **right**. **Center is open** Pedestals lock. One pencil tray.

LCK8424DE	24 x 84 x 29	92.5	348	34	\$4498
LCK7824DE	24 x 78 x 29	92.5	319	31	\$4204
LCK7224DE	24 x 72 x 29	100	280	29	\$3910
LCK6624DE	24 x 66 x 29	100	261	27	\$3855
LCK6024DE	24 x 60 x 29	100	238	24	\$3611

LCK8420DE	20 x 84 x 29	92.5	307	28	\$3986
LCK7820DE	20 x 78 x 29	92.5	285	26	\$3724
LCK7220DE	20 x 72 x 29	92.5	267	24	\$3466
LCK6620DE	20 x 66 x 29	92.5	244	22	\$3208
LCK6020DE	20 x 60 x 29	92.5	220	20	\$2951

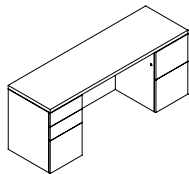

Kneespace Credenza

Standard with full to floor **box/box/file** pedestal on **left** and **file/file** pedestal on **right**. **Center is open** Pedestals lock. One pencil tray.

LCL8424E	24 x 84 x 29	100	315	34	\$3488
LCL7824E	24 x 78 x 29	100	292	31	\$3263
LCL7224E	24 x 72 x 29	100	270	29	\$3041
LCL6624E	24 x 66 x 29	100	247	27	\$2943
LCL6024E	24 x 60 x 29	100	225	24	\$2711

LCL8420E	20 x 84 x 29	100	273	28	\$3103
LCL7820E	20 x 78 x 29	100	252	26	\$2900
LCL7220E	20 x 72 x 29	100	237	24	\$2696
LCL6620E	20 x 66 x 29	100	216	22	\$2598
LCL6020E	20 x 60 x 29	100	195	20	\$2398

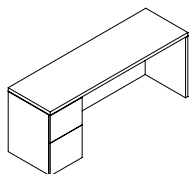

Single Pedestal Credenza - LEFT

Standard with full to floor **file/file** pedestal on **left**. Pedestal locks.

LCR8424E	24 x 84 x 29	100	315	34	\$3488
LCR7824E	24 x 78 x 29	100	292	31	\$3263
LCR7224E	24 x 72 x 29	100	270	29	\$3041
LCR6624E	24 x 66 x 29	100	247	27	\$2943
LCR6024E	24 x 60 x 29	100	225	24	\$2711

LCR8420E	20 x 84 x 29	100	273	28	\$3103
LCR7820E	20 x 78 x 29	100	252	26	\$2900
LCR7220E	20 x 72 x 29	100	237	24	\$2696
LCR6620E	20 x 66 x 29	100	216	22	\$2598
LCR6020E	20 x 60 x 29	100	195	20	\$2398

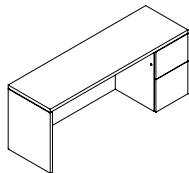

Single Pedestal Credenza - RIGHT

Standard with full to floor **file/file** pedestal on **right**. Pedestal locks.

Required Specifications

Veneer Finish
Edge

Optional Specifications

Grommet

CREDENZAS

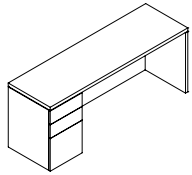

Single Pedestal Credenza - LEFT

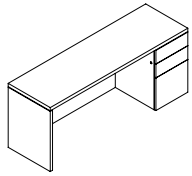

Single Pedestal Credenza - RIGHT

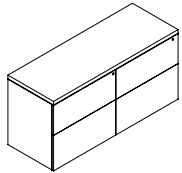

Lateral File Credenza

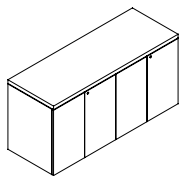

Storage Cabinet Credenza

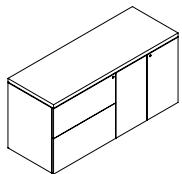

Lateral File/Storage Cabinet Credenza

MODEL#	DIMENSIONS D x W x H	FREIGHT CLASS	WT/LBS.	CUBIC FT.	LIST PRICE
LCL8424D	24 x 84 x 29	100	315	34	\$3488
LCL7824D	24 x 78 x 29	100	292	31	\$3263
LCL7224D	24 x 72 x 29	100	270	29	\$3041
LCL6624D	24 x 66 x 29	100	247	27	\$2943
LCL6024D	24 x 60 x 29	100	225	24	\$2711
LCL8420D	20 x 84 x 29	100	273	28	\$3103
LCL7820D	20 x 78 x 29	100	252	26	\$2900
LCL7220D	20 x 72 x 29	100	237	24	\$2696
LCL6620D	20 x 66 x 29	100	216	22	\$2598
LCL6020D	20 x 60 x 29	100	195	20	\$2398

Standard with full to floor **box/box/file** pedestal on **left**. Pedestal locks.

LCR8424D	24 x 84 x 29	100	315	34	\$3488
LCR7824D	24 x 78 x 29	100	292	31	\$3263
LCR7224D	24 x 72 x 29	100	270	29	\$3041
LCR6624D	24 x 66 x 29	100	247	27	\$2943
LCR6024D	24 x 60 x 29	100	225	24	\$2711
LCR8420D	20 x 84 x 29	100	273	28	\$3103
LCR7820D	20 x 78 x 29	100	252	26	\$2900
LCR7220D	20 x 72 x 29	100	237	24	\$2696
LCR6620D	20 x 66 x 29	100	216	22	\$2598
LCR6020D	20 x 60 x 29	100	195	20	\$2398

Standard with full to floor **box/box/file** pedestal on **right**. Pedestal locks.

LC7224FF	24 x 72 x 29	92.5	328	29	\$4675
LC7220FF	20 x 72 x 29	92.5	287	24	\$4124
LC6024NN	24 x 60 x 29	92.5	273	24	\$4316
LC6020NN	20 x 60 x 29	92.5	205	20	\$3655

Two 2-drawer lateral files side-by-side. Locking drawers. File bars included for side-to-side and front-to-back letter and legal filing capability. Anti-lock tilt suspension. **Not for stacking materials on lateral file drawer bottom.**

- "FF" models use two 36" wide lateral files, "NN" models use 30" wide.

LC7224GG	24 x 72 x 29	92.5	300	29	\$3576
LC7220GG	20 x 72 x 29	92.5	253	24	\$3161
LC6024MM	24 x 60 x 29	92.5	254	24	\$3299
LC6020MM	20 x 60 x 29	92.5	209	20	\$2816

Two 2-door storage cabinets side-by-side. Locking doors. Self-closing hinged doors cover one adjustable shelf.

- "GG" models use two 36" wide storage cabinets, "MM" models use 30" wide.

LCF7224	24 x 72 x 29	92.5	305	29	\$3739
LCF7220	22 x 72 x 29	92.5	272	24	\$3310
LCF6024	24 x 60 x 29	92.5	254	24	\$3176
LCF6020	22 x 60 x 29	92.5	220	20	\$2816

One 2-drawer lateral file and one storage cabinet. Locking door/drawers. Storage cabinet includes one adjustable shelf. File bars included for side-by-side and front-to-back letter and legal filing capability. Anti-lock tilt suspension. **Not for stacking materials on lateral file drawer bottom.**

Required Specifications

Veneer Finish
Edge

Optional Specifications

Grommet

CREDENZAS

MODEL# DIMENSIONS FREIGHT CLASS WT/LBS. CUBIC FT. LIST PRICE

D x W x H

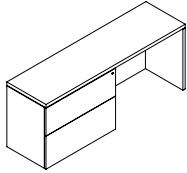

Kneespace Lateral File Credenza - LEFT

LCL8424F	24 x 84 x 29	100	305	34	\$3644
LCL7824F	24 x 78 x 29	100	285	31	\$3379
LCL7224F	24 x 72 x 29	100	261	29	\$3125
LCL6624F	24 x 66 x 29	100	239	27	\$3009
LCL6024F	24 x 60 x 29	100	218	24	\$2729
LCL8420F	20 x 84 x 29	100	273	28	\$3183
LCL7820F	20 x 78 x 29	100	252	26	\$2951
LCL7220F	20 x 72 x 29	100	237	24	\$2726
LCL6620F	20 x 66 x 29	100	216	22	\$2627
LCL6020F	20 x 60 x 29	100	195	20	\$2384

One 2-drawer lateral file on the **left**. Locking drawers. File bars included for side-to-side and front-to-back letter and legal filing capability. Anti-lock tilt suspension. **Not for stacking materials on lateral file drawer bottom.**

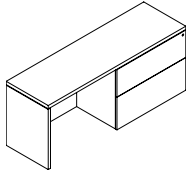

Kneespace Lateral File Credenza - RIGHT

LCR8424F	24 x 84 x 29	100	305	34	\$3644
LCR7824F	24 x 78 x 29	100	285	31	\$3379
LCR7224F	24 x 72 x 29	100	261	29	\$3125
LCR6624F	24 x 66 x 29	100	239	27	\$3009
LCR6024F	24 x 60 x 29	100	218	24	\$2729
LCR8420F	20 x 84 x 29	100	273	28	\$3183
LCR7820F	20 x 78 x 29	100	252	26	\$2951
LCR7220F	20 x 72 x 29	100	237	24	\$2726
LCR6620F	20 x 66 x 29	100	216	22	\$2627
LCR6020F	20 x 60 x 29	100	195	20	\$2384

One 2-drawer lateral file on the **right**. Locking drawers. File bars included for side-to-side and front-to-back letter and legal filing capability. Anti-lock tilt suspension. **Not for stacking materials on lateral file drawer bottom.**

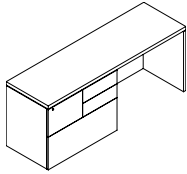

Mixed Storage Credenza - LEFT

LCL8424Z	24 x 84 x 29	100	338	34	\$4341
LCL7824Z	24 x 78 x 29	100	314	31	\$4055
LCL7224Z	24 x 72 x 29	100	290	29	\$3775
LCL6624Z	24 x 66 x 29	100	266	27	\$3644
LCL6024Z	24 x 60 x 29	100	242	24	\$2980
LCL8420Z	20 x 84 x 29	100	273	28	\$3844
LCL7820Z	20 x 78 x 29	100	252	26	\$3601
LCL7220Z	20 x 72 x 29	100	237	24	\$3350
LCL6620Z	20 x 66 x 29	100	216	22	\$3237
LCL6020Z	20 x 60 x 29	100	195	20	\$2980

Standard with two box drawers, one file drawer, and one 36"W lateral file drawer on the **left**. File drawer and lateral file drawer lock. Front-to-back and side-to-side filing. **Not for stacking materials on lateral file drawer bottom.**

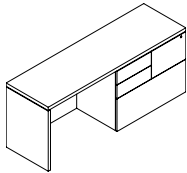

Mixed Storage Credenza - RIGHT

LCR8424Z	24 x 84 x 29	100	338	34	\$4341
LCR7824Z	24 x 78 x 29	100	314	31	\$4055
LCR7224Z	24 x 72 x 29	100	290	29	\$3775
LCR6624Z	24 x 66 x 29	100	266	27	\$3644
LCR6024Z	24 x 60 x 29	100	242	24	\$2980
LCR8420Z	20 x 84 x 29	100	273	28	\$3844
LCR7820Z	20 x 78 x 29	100	252	26	\$3601
LCR7220Z	20 x 72 x 29	100	237	24	\$3350
LCR6620Z	20 x 66 x 29	100	216	22	\$3237
LCR6020Z	20 x 60 x 29	100	195	20	\$2980

Standard with two box drawers, one file drawer, and one 36"W lateral file drawer on the **right**. File drawer and lateral file drawer lock. Front-to-back and side-to-side filing. **Not for stacking materials on lateral file drawer bottom.**

Required Specifications

Veneer Finish
Edge

Optional Specifications

Grommet

CREDENZAS

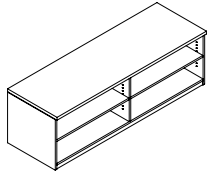

Credenza

MODEL#	DIMENSIONS D x W x H	FREIGHT CLASS	WT/LBS.	CUBIC FT.	LIST PRICE
LCO7224H23	24 x 72 x 23	92.5	305	29	\$2420
LCO7220H23	20 x 72 x 23	92.5	272	24	\$2115
LCO6024H23	24 x 60 x 23	92.5	254	24	\$2017
LCO6020H23	20 x 60 x 23	92.5	220	20	\$1763

Standard with open storage on **both sides**.

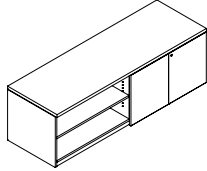

Credenza

LCOG7224H23	24 x 72 x 23	92.5	328	29	\$2438
LCOG7220H23	20 x 72 x 23	92.5	287	24	\$2133
LCOM6024H23	24 x 60 x 23	92.5	273	24	\$2239
LCOM6020H23	20 x 60 x 23	92.5	205	20	\$1865

Standard with open storage on the **left** and one storage cabinet on the **right**. Storage cabinet includes one adjustable shelf.

- "G" model uses 36" wide storage cabinets, "M" model uses 30" wide.

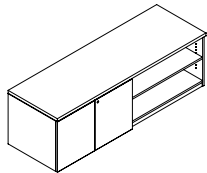

Credenza

LCG07224H23	24 x 72 x 23	92.5	328	29	\$2438
LCG07220H23	20 x 72 x 23	92.5	287	24	\$2133
LCM06024H23	24 x 60 x 23	92.5	273	24	\$2239
LCM06020H23	20 x 60 x 23	92.5	205	20	\$1865

Standard with open storage on the **right** and one storage cabinet on the **left**. Storage cabinet includes one adjustable shelf.

- "G" model uses 36" wide storage cabinets, "M" model uses 30" wide.

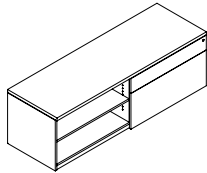

Credenza

LCOF7224H23	24 x 72 x 23	92.5	300	29	\$2969
LCOF7220H23	20 x 72 x 23	92.5	253	24	\$2591
LCON6024H23	24 x 60 x 23	92.5	254	24	\$2595
LCON6020H23	20 x 60 x 23	92.5	209	20	\$2264

Standard with one **box/file** drawer on **right** and open storage on the **left**. File drawer and lateral file drawer lock. Front-to-back and side-to-side filing. **Not for stacking materials on lateral file drawer bottom.**

- "F" models use 36" wide lateral files, "N" models use 30" wide.

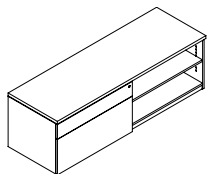

Credenza

LCFO7224H23	24 x 72 x 23	92.5	300	29	\$2969
LCFO7220H23	20 x 72 x 23	92.5	253	24	\$2591
LCNO6024H23	24 x 60 x 23	92.5	254	24	\$2595
LCNO6020H23	20 x 60 x 23	92.5	209	20	\$2264

Standard with one **box/file** drawer on **left** and open storage on the **right**. File drawer and lateral file drawer lock. Front-to-back and side-to-side filing. **Not for stacking materials on lateral file drawer bottom.**

- "F" models use 36" wide lateral files, "N" models use 30" wide.

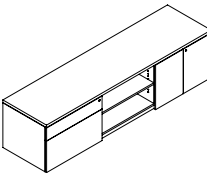

Credenza

LCNOM9024H23	24 x 90 x 23	92.5	300	29	\$5188
LCNOM9020H23	20 x 90 x 23	92.5	300	29	\$4926

Standard with one **box/file** drawer on **left**, open storage in the **center**, and one storage cabinet on the **right**. Storage cabinet includes one adjustable shelf. File drawer and lateral file drawer lock. Front-to-back and side-to-side filing. **Not for stacking materials on lateral file drawer bottom.**

Required Specifications

Veneer Finish
Edge

Optional Specifications

Grommet

CREDENZAS

MODEL# DIMENSIONS FREIGHT CLASS WT/LBS. CUBIC FT. LIST PRICE

D x W x H

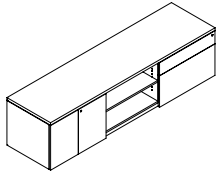

Credenza

LCMON9024H23	24 x 90 x 23	92.5	300	29	\$5188
LCMON9020H23	20 x 90 x 23	92.5	300	29	\$4926

Standard with one **box/file** drawer on **right**, open storage in the **center**, and one storage cabinet on the **left**. Storage cabinet includes one adjustable shelf. File drawer and lateral file drawer lock. Front-to-back and side-to-side filing. **Not for stacking materials on lateral file drawer bottom.**

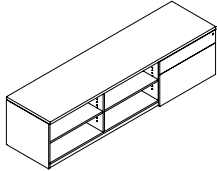

Credenza

LCOON9024H23	24 x 90 x 23	92.5	300	29	\$4996
LCOON9020H23	20 x 90 x 23	92.5	300	29	\$4731

Standard with one **box/file** drawer on **right** and open storage in the **center** and **left**. File drawer and lateral file drawer lock. Front-to-back and side-to-side filing. **Not for stacking materials on lateral file drawer bottom.**

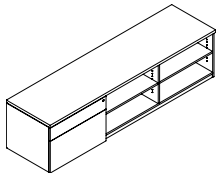

Credenza

LCNOO9024H23	24 x 90 x 23	92.5	300	29	\$4996
LCNOO9020H23	20 x 90 x 23	92.5	300	29	\$4731

Standard with one **box/file** drawer on **left** and open storage in the **center** and **right**. File drawer and lateral file drawer lock. Front-to-back and side-to-side filing. **Not for stacking materials on lateral file drawer bottom.**

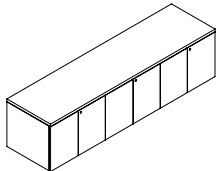

Credenza

LCMMM9024H23	24 x 90 x 23	92.5	300	29	\$4803
LCMMM9020H23	20 x 90 x 23	92.5	300	29	\$4001

Standard with **three** storage cabinets. Storage cabinets include one adjustable shelf per cabinet.

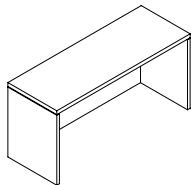

Credenza Shell

LC10824H23	24 x 108 x 23	125	348	44	\$2743
LC10224H23	24 x 102 x 23	100	329	41	\$2609
LC9624H23	24 x 96 x 23	125	309	39	\$2464
LC9024H23	24 x 90 x 23	100	290	36	\$2329
LC8424H23	24 x 84 x 23	125	271	34	\$2191
LC7824H23	24 x 78 x 23	100	251	31	\$2046
LC7224H23	24 x 72 x 23	100	232	29	\$1911
LC6624H23	24 x 66 x 23	125	213	27	\$1846
LC6024H23	24 x 60 x 23	100	193	24	\$1700
LC10820H23	22 x 108 x 23	100	309	36	\$2162
LC10220H23	22 x 102 x 23	100	291	34	\$2042
LC9620H23	22 x 96 x 23	100	273	32	\$1919
LC9020H23	22 x 90 x 23	100	255	30	\$1796
LC8420H23	22 x 84 x 23	100	237	28	\$1676
LC7820H23	22 x 78 x 23	100	219	26	\$1552
LC7220H23	22 x 72 x 23	100	206	24	\$1428
LC6620H23	22 x 66 x 23	100	188	22	\$1374
LC6020H23	22 x 60 x 23	100	169	20	\$1247

Standard with **no pedestals**. Flush full modesty panel. 96" w and larger includes a center support leg. If using storage component shells underneath to support the worksurface, **no more than 72" may be left unsupported.**

Required Specifications

Veneer Finish
Edge

Optional Specifications

Grommet

CORNERS

MODEL#

DIMENSIONS

FREIGHT CLASS

WT/LBS.

CUBIC FT.

LIST PRICE

- A Corner Desk is used to connect to a Linking Bridge and Linking Credenza, or Connectable Table
- Cable management tray is included.
- Full Modesty Panel option.
- 5-Sided Corners include a GM1 grommet in the top center position. Grommets are available as an option on Extended Corners.
- Hand of Linking Credenza is determined by location of full end panel from user side.
- Hand of Extended Corner is determined by location of long narrow end from user side.
- Connecting sides feature a self edge.

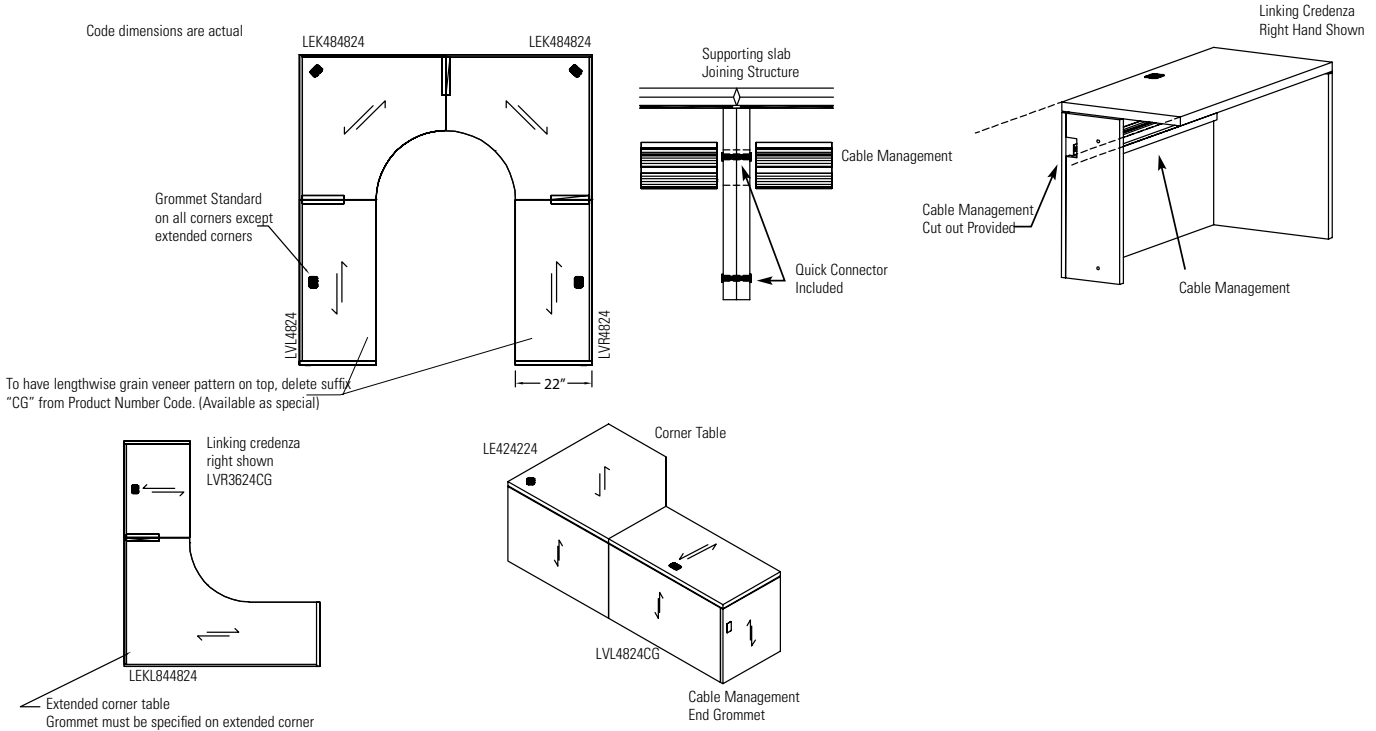

5-SIDED CORNERS

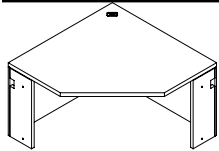

5-Sided Corner

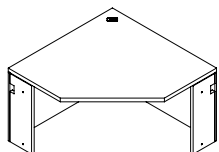

5-Sided Corner

	D x W x H				
LE484824	48 x 48 x 29	150	201	39	\$2166
LE424224	42 x 42 x 29	150	155	30	\$1726
LE363624	36 x 36 x 29	125	135	22	\$1650

Connects to **24" D** connectables, returns, extended corners, storage/lateral file credenzas, credenzas and bridges. Includes grommet and installed horizontal wire management. Narrow end panels on left and right.

- *Not freestanding*

LE484820	48 x 48 x 29	150	196	39	\$2166
LE424220	42 x 42 x 29	150	150	30	\$1726
LE363620	36 x 36 x 29	150	130	22	\$1650

Connects to **20" D** connectables, returns, extended corners, storage/lateral file credenzas, credenzas and bridges. Includes grommet and installed horizontal wire management. Narrow end panels on left and right.

- *Not freestanding*

Required Specifications

Veneer Finish
Edge

Optional Specifications

Grommet

LEFT EXTENDED CORNERS

MODEL# DIMENSIONS FREIGHT CLASS WT/LBS. CUBIC FT. LIST PRICE

D x W x H

LEKL844824	24-48 x 84 x 29	150	338	68	\$3197
LEKL784824	24-48 x 78 x 29	150	314	63	\$3154
LEKL724824	24-48 x 72 x 29	150	290	58	\$2975
LEKL664824	24-48 x 66 x 29	150	266	52	\$2827
LEKL604824	24-48 x 60 x 29	150	242	48	\$2641
LEKL844820	20-48 x 84 x 29	150	338	68	\$3146
LEKL784820	20-48 x 78 x 29	150	314	63	\$3081
LEKL724820	20-48 x 72 x 29	150	290	58	\$2903
LEKL664820	20-48 x 66 x 29	150	266	52	\$2754
LEKL604820	20-48 x 60 x 29	150	242	48	\$2569

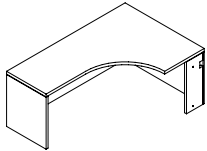

Left Extended Corner

Extended worksurface on **left**. **Full end panel on left, narrow end panel on right**. Connects to Linking Bridges, Extended Corners and Connectable Tables.

RIGHT EXTENDED CORNERS

LEKR488424	24-48 x 84 x 29	150	338	68	\$3197
LEKR487824	24-48 x 78 x 29	150	314	63	\$3154
LEKR487224	24-48 x 72 x 29	150	290	58	\$2975
LEKR486624	24-48 x 66 x 29	150	266	52	\$2827
LEKR486024	24-48 x 60 x 29	150	242	48	\$2641
LEKR488420	20-48 x 84 x 29	150	338	68	\$3146
LEKR487820	20-48 x 78 x 29	150	314	63	\$3081
LEKR487220	20-48 x 72 x 29	150	290	58	\$2903
LEKR486620	20-48 x 66 x 29	150	266	52	\$2754
LEKR486020	20-48 x 60 x 29	150	242	48	\$2569

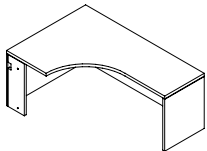

Right Extended Corner

Extended worksurface on **right**. **Full end panel on right, narrow end panel on left**. Connects to Linking Bridges, Extended Corners and Connectable Tables.

CONNECTABLE TABLES - LEFT

LVL9624CG	24 x 96 x 29	150	200	39	\$2351
LVL9024CG	24 x 90 x 29	150	187	36	\$2216
LVL8424CG	24 x 84 x 29	150	174	34	\$2090
LVL7824CG	24 x 78 x 29	150	162	31	\$1955
LVL7224CG	24 x 72 x 29	150	149	29	\$1828
LVL6624CG	24 x 66 x 29	150	141	27	\$1734
LVL6024CG	24 x 60 x 29	150	132	24	\$1639
LVL5424CG	24 x 54 x 29	150	121	22	\$1559
LVL4824CG	24 x 48 x 29	125	115	19	\$1486
LVL4224CG	24 x 42 x 29	150	99	17	\$1294
LVL3624CG	24 x 36 x 29	150	83	15	\$1258
LVL3024CG	24 x 30 x 29	125	77	12	\$1240
LVL2424CG	24 x 24 x 29	125	61	10	\$1083

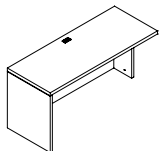

24" Deep Connectable Table - LEFT

Full end panel on left. Right narrow end panel connects to **24"D** center/right connectable table; **24"D** extended corners; **24"D** 5-sided corners; Grommet in worksurface.

- To remove cross grain veneer pattern on top, **delete suffix "CG"** from the model number. Available as a special - no upcharge.

Required Specifications

Veneer Finish
Edge

Optional Specifications

Grommet

CONNECTABLE TABLES - LEFT

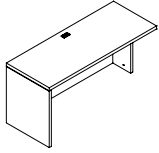

20" Deep Connectable Table - LEFT

MODEL#	DIMENSIONS D x W x H	FREIGHT CLASS	WT/LBS.	CUBIC FT.	LIST PRICE
LVL9620CG	20 x 96 x 29	150	187	39	\$1911
LVL9020CG	20 x 90 x 29	150	175	36	\$1791
LVL8420CG	20 x 84 x 29	150	163	34	\$1672
LVL7820CG	20 x 78 x 29	150	152	31	\$1552
LVL7220CG	20 x 72 x 29	150	140	29	\$1432
LVL6620CG	20 x 66 x 29	150	133	27	\$1345
LVL6020CG	20 x 60 x 29	150	125	24	\$1258
LVL5420CG	20 x 54 x 29	150	113	22	\$1185
LVL4820CG	20 x 48 x 29	150	110	19	\$1112
LVL4220CG	20 x 42 x 29	150	95	17	\$941
LVL3620CG	20 x 36 x 29	150	80	15	\$906
LVL3020CG	20 x 30 x 29	125	75	12	\$891
LVL2420CG	20 x 24 x 29	125	60	10	\$746

Full end panel on left. Right narrow end panel connects to **20"D** center/right connectable table; **20"D** 5-sided corners; Grommet in worksurface.

- To remove cross grain veneer pattern on top, **delete suffix "CG"** from the model number. Available as a special - no upcharge.

CONNECTABLE TABLES - RIGHT

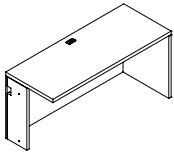

24" Deep Connectable Table - RIGHT

LVR9624CG	24 x 96 x 29	150	200	39	\$2351
LVR9024CG	24 x 90 x 29	150	187	36	\$2216
LVR8424CG	24 x 84 x 29	150	174	34	\$2090
LVR7824CG	24 x 78 x 29	150	162	31	\$1955
LVR7224CG	24 x 72 x 29	150	149	29	\$1828
LVR6624CG	24 x 66 x 29	150	141	27	\$1734
LVR6024CG	24 x 60 x 29	150	132	24	\$1639
LVR5424CG	24 x 54 x 29	150	121	22	\$1559
LVR4824CG	24 x 48 x 29	125	115	19	\$1486
LVR4224CG	24 x 42 x 29	150	99	17	\$1294
LVR3624CG	24 x 36 x 29	150	83	15	\$1258
LVR3024CG	24 x 30 x 29	125	77	12	\$1240
LVR2424CG	24 x 24 x 29	125	61	10	\$1083

Full end panel on right. Left narrow end panel connects to **24"D** center/left connectable table; **24"D** extended corners, **24"D** 5-sided corners; Grommet in worksurface.

- To remove cross grain veneer pattern on top, **delete suffix "CG"** from the model number. Available as a special - no upcharge.

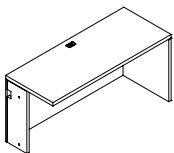

20" Deep Connectable Table - RIGHT

LVR9620CG	20 x 96 x 29	150	187	39	\$1911
LVR9020CG	20 x 90 x 29	150	175	36	\$1791
LVR8420CG	20 x 84 x 29	150	163	34	\$1672
LVR7820CG	20 x 78 x 29	150	152	31	\$1552
LVR7220CG	20 x 72 x 29	150	140	29	\$1432
LVR6620CG	20 x 66 x 29	150	133	27	\$1345
LVR6020CG	20 x 60 x 29	150	125	24	\$1258
LVR5420CG	20 x 54 x 29	150	113	22	\$1185
LVR4820CG	20 x 48 x 29	150	110	19	\$1112
LVR4220CG	20 x 42 x 29	150	95	17	\$941
LVR3620CG	20 x 36 x 29	150	80	15	\$906
LVR3020CG	20 x 30 x 29	125	75	12	\$891
LVR2420CG	20 x 24 x 29	125	60	10	\$746

Full end panel on right. Left narrow end panel connects to **20"D** center/left connectable table; **20"D** 5-sided corners; Grommet in worksurface.

- To remove cross grain veneer pattern on top, **delete suffix "CG"** from the model number. Available as a special - no upcharge.

Required Specifications

Veneer Finish
Edge

Optional Specifications

Grommet

CONNECTABLE TABLES

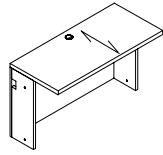

24" Deep Connectable Table

MODEL#	DIMENSIONS D x W x H	FREIGHT CLASS	WT/LBS.	CUBIC FT.	LIST PRICE
LV6024CG	24 x 60 x 29	150	132	24	\$1592
LV5424CG	24 x 54 x 29	150	121	22	\$1501
LV4824CG	24 x 48 x 29	125	115	19	\$1411
LV4224CG	24 x 42 x 29	150	99	17	\$1181
LV3624CG	24 x 36 x 29	150	83	15	\$1218
LV3024CG	24 x 30 x 29	125	77	12	\$1116
LV2424CG	24 x 24 x 29	125	61	10	\$935

Narrow end panels on left and right connects to 24"D connectable table; 24"D extended corners, 24"D 5-sided corners; Grommet in worksurface.

- To remove cross grain veneer pattern on top, delete suffix "CG" from the model number. Available as a special - no upcharge.

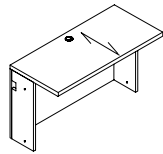

22" Deep Connectable Table

LV6020CG	20 x 60 x 29	150	125	24	\$1225
LV5420CG	20 x 54 x 29	150	113	22	\$1152
LV4820CG	20 x 48 x 29	150	110	19	\$1080
LV4220CG	20 x 42 x 29	150	95	17	\$901
LV3620CG	20 x 36 x 29	150	80	15	\$873
LV3020CG	20 x 30 x 29	125	75	12	\$855
LV2420CG	20 x 24 x 29	125	60	10	\$720

Narrow end panels on left and right connects to 22"D connectable table; 22"D extended corners, 22"D 5-sided corners; Grommet in worksurface.

- To remove cross grain veneer pattern on top, delete suffix "CG" from the model number. Available as a special - no upcharge.

"D" ISLANDS

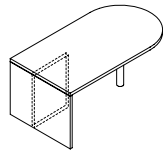

"D" Island - Full End Panel (T-Base) & Monopost

LDD8430	30 x 84 x 29	125	343	51	\$3553
LDD7230	30 x 72 x 29	125	264	36	\$2823
LDD6630	30 x 66 x 29	125	245	40	\$2823
LDD6030	30 x 60 x 29	125	225	30	\$2718

Connects to Linking Bridges or Executive Returns. Attaching hardware included. **Not freestanding.**

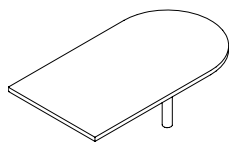

"D" Island with Monopost

LRD8430	30 x 84 x 29	125	135	51	\$2536
LRD7230	30 x 72 x 29	125	99	36	\$2017
LRD6630	30 x 66 x 29	125	99	40	\$2017
LRD6030	30 x 60 x 29	125	83	30	\$1941

Attaches to edge of worksurfaces with molding edge. Attaching hardware included. Shipped RTA (ready to assemble).

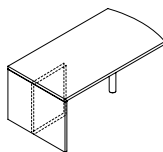

"D" Island - Full End Panel (T-Base) & Monopost, Bow End

LDDBE8430	30 x 84 x 29	125	343	51	\$3553
LDDBE7230	30 x 72 x 29	125	264	36	\$2823
LDDBE6630	30 x 66 x 29	125	245	40	\$2823
LDDBE6030	30 x 60 x 29	125	225	30	\$2715

Connects to Linking Bridges or Executive Returns. Attaching hardware included. **Not freestanding.**

Required Specifications

- Veneer Finish
- Edge
- Monopost Finish - D Islands

Optional Specifications

- Grommet
- Modesty Upgrade
- Modesty Panel
- Monopost (Base) Upgrade - D Islands

"D" ISLANDS

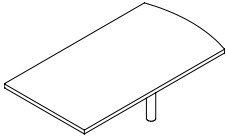

"D" Island with Monopost, Bow End

MODEL#	DIMENSIONS	FREIGHT CLASS	WT/LBS.	CUBIC FT.	LIST PRICE
	D x W x H				
LRDBE8430	30 x 84 x 29	125	135	51	\$2536
LRDBE7230	30 x 72 x 29	125	99	36	\$2017
LRDBE6630	30 x 66 x 29	125	99	40	\$2017
LRDBE6030	30 x 60 x 29	125	83	30	\$1941

Attaches to edge of worksurfaces with molding edge. Attaching hardware included. Shipped RTA (ready to assemble).

PIANO DESKS

- Can be ordered as a shell or with pedestals.
- Components include a GM1 grommet in the top center position.
- Hand of Rectangular Desk is determined by location of pedestal from user side.
- Hand of "D" Top is determined by outward orientation of curved end from user projection.
- Hand of "P" Top is determined by outward orientation of conference end from user projection.
- Connectable Tables and Bridges - To remove cross grain veneer pattern on top, delete suffix "CG" from the model number. Available as a special - no upcharge.

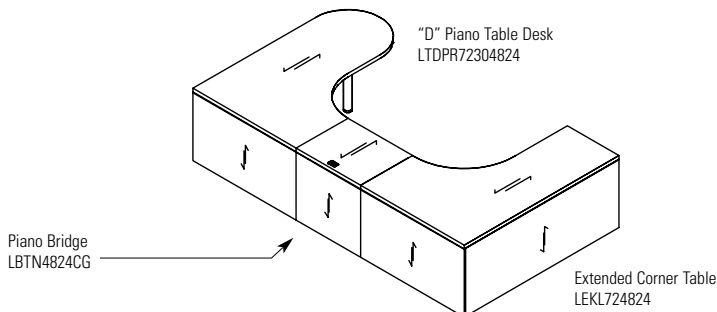
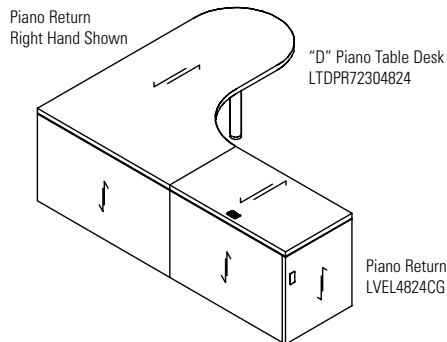
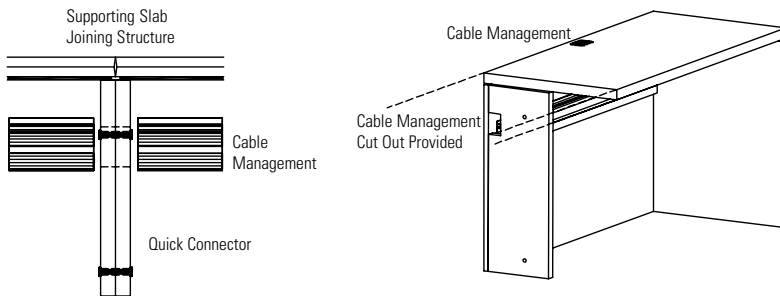

Required Specifications

Veneer Finish
Edge
Monopost Finish

Optional Specifications

Grommet
Monopost (Base) Upgrade

PIANO DESKS

MODEL# DIMENSIONS FREIGHT CLASS WT/LBS. CUBIC FT. LIST PRICE

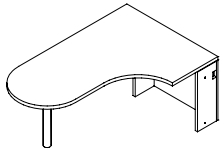

"D" Island LEFT - Full End Panel & Monopost, Piano Desk

	D x W x H				
LTDPL84304824	48 x 84 x 29	150	406	68	\$2943
LTDPL72304824	48 x 72 x 29	125	348	58	\$2580

Extended island worksurface on the **left**. Narrow end panel on right connects to **24"D** returns or bridges **for Piano Desks Only** (see pg. 107). **Not freestanding**. Includes installed horizontal wire management.

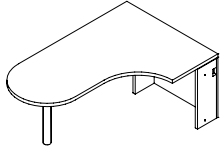

"D" Island LEFT - Full End Panel & Monopost, Piano Desk

LTDPL84304820	48 x 84 x 29	150	406	68	\$2871
LTDPL72304820	48 x 72 x 29	125	348	58	\$2507

Extended island worksurface on the **left**. Narrow end panel on right connects to **20"D** returns or bridges **for Piano Desks Only** (see pg. 107). **Not freestanding**. Includes installed horizontal wire management.

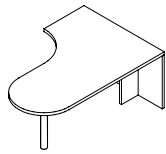

"D" Island RIGHT - Full End Panel & Monopost, Piano Desk

LTDPR84304824	48 x 84 x 29	150	406	68	\$2943
LTDPR72304824	48 x 72 x 29	125	348	58	\$2580

Extended island worksurface on the **right**. Narrow end panel on left connects to **24"D** returns or bridges **for Piano Desks Only** (see pg. 107). **Not freestanding**. Includes installed horizontal wire management.

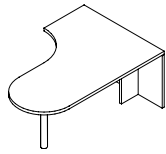

"D" Island RIGHT - Full End Panel & Monopost, Piano Desk

LTDPR84304820	48 x 84 x 29	150	406	68	\$2871
LTDPR72304820	48 x 72 x 29	125	348	58	\$2507

Extended island worksurface on the **right**. Narrow end panel on left connects to **20"D** returns or bridges **for Piano Desks Only** (see pg. 107). **Not freestanding**. Includes installed horizontal wire management.

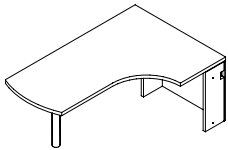

"D" Island LEFT - Full End Panel & Monopost, Piano Desk - Bow End

LDBEPL84304824	48 x 84 x 29	150	406	68	\$2943
LDBEPL72304824	48 x 72 x 29	125	348	58	\$2580

Extended island worksurface on the **left**. Narrow end panel on right connects to **24"D** returns or bridges **for Piano Desks Only** (see pg. 107). **Not freestanding**. Includes installed horizontal wire management.

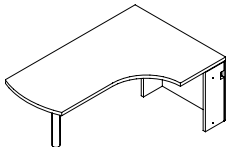

"D" Island LEFT - Full End Panel & Monopost, Piano Desk - Bow End

LDBEPL84304820	48 x 84 x 29	150	406	68	\$2871
LDBEPL72304820	48 x 72 x 29	125	348	58	\$2507

Extended island worksurface on the **left**. Narrow end panel on right connects to **20"D** returns or bridges **for Piano Desks Only** (see pg. 107). **Not freestanding**. Includes installed horizontal wire management.

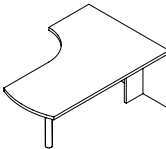

"D" Island RIGHT - Full End Panel & Monopost, Piano Desk - Bow End

LDBEPR84304824	48 x 84 x 29	150	406	68	\$2943
LDBEPR72304824	48 x 72 x 29	125	348	58	\$2580

Extended island worksurface on the **right**. Narrow end panel on left connects to **24"D** returns or bridges **for Piano Desks Only** (see pg. 107). **Not freestanding**. Includes installed horizontal wire management.

Required Specifications

Veneer Finish
Edge
Monopost Finish

Optional Specifications

Grommet
Monopost (Base) Upgrade

PIANO DESK

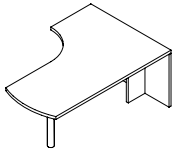

"D" Island RIGHT - Full End Panel & Monopost, Piano Desk - Bow End

MODEL#	DIMENSIONS D x W x H	FREIGHT CLASS	WT/LBS.	CUBIC FT.	LIST PRICE
LDBEPR84304820	48 x 84 x 29	150	406	68	\$2871
LDBEPR72304820	48 x 72 x 29	125	348	58	\$2507

Extended island worksurface on the **right**. Narrow end panel on left connects to **20"D** returns or bridges **for Piano Desks Only** (see pg. 107). **Not freestanding**. Includes installed horizontal wire management.

CONNECTABLE TABLES - FOR PIANO DESKS

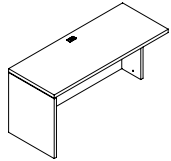

24" Deep Connectable Table - LEFT For Piano Desk

LVEL8424CG	24 x 84 x 29	150	174	34	\$2162
LVEL7824CG	24 x 78 x 29	150	162	31	\$2024
LVEL7224CG	24 x 72 x 29	150	149	29	\$1893
LVEL6624CG	24 x 66 x 29	150	141	27	\$1791
LVEL6024CG	24 x 60 x 29	150	132	24	\$1694
LVEL5424CG	24 x 54 x 29	150	121	22	\$1610
LVEL4824CG	24 x 48 x 29	125	115	19	\$1534
LVEL4224CG	24 x 42 x 29	150	99	17	\$1334
LVEL3624CG	24 x 36 x 29	150	83	15	\$1298

Full end panel on left. Right narrow end panel connects to **24"D** right connectable table, "D" islands, Boat shaped islands, "P" islands or Delta islands with "T" bases **for Piano Desks Only**. Grommet in worksurface. Shipped RTA (ready to assemble).

- To remove cross grain veneer pattern on top, **delete suffix "CG"** from the model number. Available as a special - no upcharge.

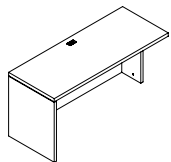

20" Deep Connectable Table - LEFT For Piano Desk

LVEL8420CG	20 x 84 x 29	150	174	34	\$1672
LVEL7820CG	20 x 78 x 29	150	162	31	\$1552
LVEL7220CG	20 x 72 x 29	150	149	29	\$1432
LVEL6620CG	20 x 66 x 29	150	141	27	\$1345
LVEL6020CG	20 x 60 x 29	150	132	24	\$1258
LVEL5420CG	20 x 54 x 29	150	121	22	\$1185
LVEL4820CG	20 x 48 x 29	125	115	19	\$1112
LVEL4220CG	20 x 42 x 29	150	99	17	\$941
LVEL3620CG	20 x 36 x 29	150	83	15	\$906

Full end panel on left. Right narrow end panel connects to **20"D** right connectable table, "D" islands, Boat shaped islands, "P" islands or Delta islands with "T" bases **for Piano Desks Only**. Grommet in worksurface. Shipped RTA (ready to assemble).

- To remove cross grain veneer pattern on top, **delete suffix "CG"** from the model number. Available as a special - no upcharge.

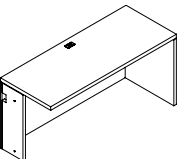

24" Deep Connectable Table - RIGHT For Piano Desk

LVER8424CG	24 x 84 x 29	150	174	34	\$2162
LVER7824CG	24 x 78 x 29	150	162	31	\$2024
LVER7224CG	24 x 72 x 29	150	149	29	\$1893
LVER6624CG	24 x 66 x 29	150	141	27	\$1791
LVER6024CG	24 x 60 x 29	150	132	24	\$1694
LVER5424CG	24 x 54 x 29	150	121	22	\$1610
LVER4824CG	24 x 48 x 29	125	115	19	\$1534
LVER4224CG	24 x 42 x 29	150	99	17	\$1334
LVER3624CG	24 x 36 x 29	150	83	15	\$1298

Full end panel on right. Left narrow end panel connects to **24"D** left connectable table, "D" islands, Boat shaped islands, "P" islands or Delta islands with "T" bases **for Piano Desks Only**. Grommet in worksurface. Shipped RTA (ready to assemble).

- To remove cross grain veneer pattern on top, **delete suffix "CG"** from the model number. Available as a special - no upcharge.

Required Specifications

Veneer Finish
Edge
Monopost Finish - Piano Desk

Optional Specifications

Grommet
Monopost (Base) Upgrade - Piano Desk

CONNECTABLE TABLES - FOR PIANO DESKS

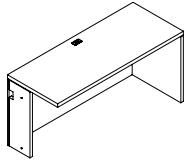

20" Deep Connectable Table - RIGHT For Piano Desk

MODEL#	DIMENSIONS	FREIGHT CLASS	WT/LBS.	CUBIC FT.	LIST PRICE
D x W x H					
LVER8420CG	20 x 84 x 29	150	174	34	\$1672
LVER7820CG	20 x 78 x 29	150	162	31	\$1552
LVER7220CG	20 x 72 x 29	150	149	29	\$1432
LVER6620CG	20 x 66 x 29	150	141	27	\$1345
LVER6020CG	20 x 60 x 29	150	132	24	\$1258
LVER5420CG	20 x 54 x 29	150	121	22	\$1185
LVER4820CG	20 x 48 x 29	125	115	19	\$1112
LVER4220CG	20 x 42 x 29	150	99	17	\$941
LVER3620CG	20 x 36 x 29	150	83	15	\$906

Full end panel on right. Left narrow end panel connects to 20"D left connectable table, "D" islands, Boat shaped islands, "P" islands or Delta islands with "T" bases **for Piano Desks Only.** Grommet in worksurface. Shipped RTA (ready to assemble).

- To remove cross grain veneer pattern on top, **delete suffix "CG"** from the model number. Available as a special - no upcharge.

BRIDGES - FOR PIANO DESKS

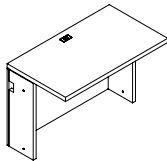

Flush Bridge

LBTN4824CG	24 x 48 x 29	125	116	19	\$1356
LBTN4224CG	24 x 42 x 29	125	102	17	\$1181
LBTN3624CG	24 x 36 x 29	150	87	15	\$1145
LBTN3024CG	24 x 30 x 29	125	73	12	\$1123
LBTN2424CG	24 x 24 x 29	150	58	10	\$989
LBTN1824CG	24 x 18 x 29	150	43	8	\$811
LBTN1224CG	24 x 12 x 29	150	29	5	\$629

Full end panel on both sides connects to 24"D worksurfaces, "D" islands, Boat shaped islands, "P" islands or Delta islands with "T" bases **for Piano Desks Only.** Grommet in worksurface. Shipped RTA (ready to assemble).

- To remove cross grain veneer pattern on top, **delete suffix "CG"** from the model number. Available as a special - no upcharge.

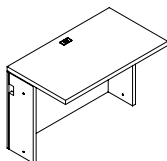

Flush Bridge

LBTN4820CG	20 x 48 x 29	125	116	19	\$1080
LBTN4220CG	20 x 42 x 29	125	102	17	\$901
LBTN3620CG	20 x 36 x 29	150	87	15	\$873
LBTN3020CG	20 x 30 x 29	125	73	12	\$855
LBTN2420CG	20 x 24 x 29	150	58	10	\$720
LBTN1820CG	20 x 18 x 29	150	43	8	\$684
LBTN1220CG	20 x 12 x 29	150	29	5	\$636

Full end panel on both sides connects to 20"D worksurfaces, "D" islands, Boat shaped islands, "P" islands or Delta islands with "T" bases **for Piano Desks Only.** Grommet in worksurface. Shipped RTA (ready to assemble).

- To remove cross grain veneer pattern on top, **delete suffix "CG"** from the model number. Available as a special - no upcharge.

MODESTY PANEL OPTIONS

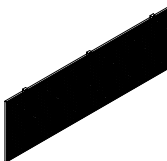

Metal Modesty Panel Upgrade

CMP72	1 x 67 x 18	--	20	1	\$1096
CMP66	1 x 61 x 18	--	18	1	\$1061
CMP60	1 x 55 x 18	--	16	1	\$1044
CMP54	1 x 49 x 18	--	14	1	\$1026
CMP48	1 x 43 x 18	--	13	1	\$1011

Straight modesty panel. Attaches to underside of worksurface. **Can not be retrofitted in the field.**

- **Available in Black (E) and Tungsten (K). Please Specify.**
- CMP72 - Specify on 96" x 42" "P" Top Islands, 96" x 48" Islands for Piano Desks or 96" x 36" Delta Islands.
- CMP66 - Specify on 84" x 36" "D" Top Islands.
- CMP60 - Specify on 84" x 42" "P" Top Islands or 84" x 48" Islands for Piano Desks.
- CMP54 - Specify on 72" x 36" or 72" x 30" "D" Top Islands, 72" x 36" or 72" x 30" Boat Shaped Islands
- CMP48- Specify on 66" x 36" , 60" x 30" "D" Top Islands, 72" x 42" "P" Top Islands or 72" x 48" Islands for Piano Desks.

Required Specifications

Veneer Finish
Edge
Metal Finish - Modesty Panel

Optional Specifications

Grommet

MODESTY PANEL OPTIONS

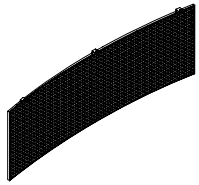

Metal Modesty Panel Upgrade, Curved

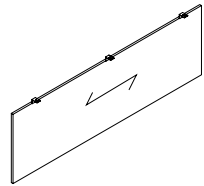

Veneer Modesty Panel Upgrade

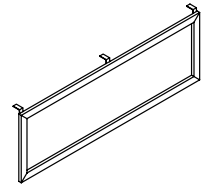

Glass Modesty Panel Upgrade

MODEL#	DIMENSIONS D x W x H	FREIGHT CLASS	WT/LBS.	CUBIC FT.	LIST PRICE
CMMP72	0.50 x 67 x 18	--	20	1	\$1096
CMMP66	0.50 x 61 x 18	--	18	1	\$1061
CMMP60	0.50 x 55 x 18	--	16	1	\$1044
CMMP54	0.50 x 49 x 18	--	14	1	\$1026
CMMP48	0.50 x 43 x 18	--	13	1	\$1011

Curved modesty panel. Attaches to underside of worksurface. **Can not be retrofitted in the field.**

• **Available in Black (E) and Tungsten (K). Please Specify.**

- CMP72 - Specify on 96" x 42" "P" Top Islands, 96" x 48" Islands for Piano Desks or 96" x 36" Delta Islands.
- CMP66 - Specify on 84" x 36" "D" Top Islands.
- CMP60 - Specify on 84" x 42" "P" Top Islands or 84" x 48" Islands for Piano Desks.
- CMP54 - Specify on 72" x 36" or 72" x 30" "D" Top Islands, 72" x 36" or 72" x 30" Boat Shaped Islands
- CMP48 - Specify on 66" x 36" , 60" x 30" "D" Top Islands, 72" x 42" "P" Top Islands or 72" x 48" Islands for Piano Desks.

CMP72W	0.75 x 67 x 18	--	20	1	\$1096
CMP66W	0.75 x 61 x 18	--	18	1	\$1061
CMP60W	0.75 x 55 x 18	--	16	1	\$1044
CMP54W	0.75 x 49 x 18	--	14	1	\$1026
CMP48W	0.75 x 43 x 18	--	13	1	\$1011

Straight modesty panel. Attaches to underside of worksurface. **Can not be retrofitted in the field.**

- CMP72W - Specify on "P" Top Islands or 96" x 48" Islands for Piano Desks.
- CMP66W - Specify on 84" x 36" "D" Top Islands.
- CMP60W - Specify on 84" x 42" "P" Top Islands or 84" x 48" Islands for Piano Desks.
- CMP54W - Specify on 72" x 30" "D" Top Islands.
- CMP48W - Specify on 66" x 36" , 60" x 30" "D" Top Islands, 72" x 42" "P" Top Islands or 72" x 48" Islands for Piano Desks.

CMP72G	0.75 x 67 x 18	--	20	1	\$1681
CMP66G	0.75 x 61 x 18	--	18	1	\$1589
CMP60G	0.75 x 55 x 18	--	16	1	\$1451
CMP54G	0.75 x 49 x 18	--	14	1	\$1352
CMP48G	0.75 x 43 x 18	--	13	1	\$1291

Straight modesty panel. Translucent, screened glass. Aluminum box frame construction in Tungsten Only. Attaches to underside of worksurface. **Can not be retrofitted in the field.**

- CMP72G - Specify on "P" Top Islands or 96" x 48" Islands for Piano Desks.
- CMP66G - Specify on 84" x 36" "D" Top Islands.
- CMP60G - Specify on 84" x 42" "P" Top Islands or 84" x 48" Islands for Piano Desks.
- CMP54G - Specify on 72" x 30" "D" Top Islands.
- CMP48G - Specify on 66" x 36" , 60" x 30" "D" Top Islands, 72" x 42" "P" Top Islands or 72" x 48" Islands for Piano Desks.
- Tungsten finish on the aluminum box frame closely resembles the existing Tungsten finish.

Required Specifications

Metal Finish

SIDE-BY-SIDE COMPONENTS MODEL# DIMENSIONS FREIGHT CLASS WT/LBS. CUBIC FT. LIST PRICE

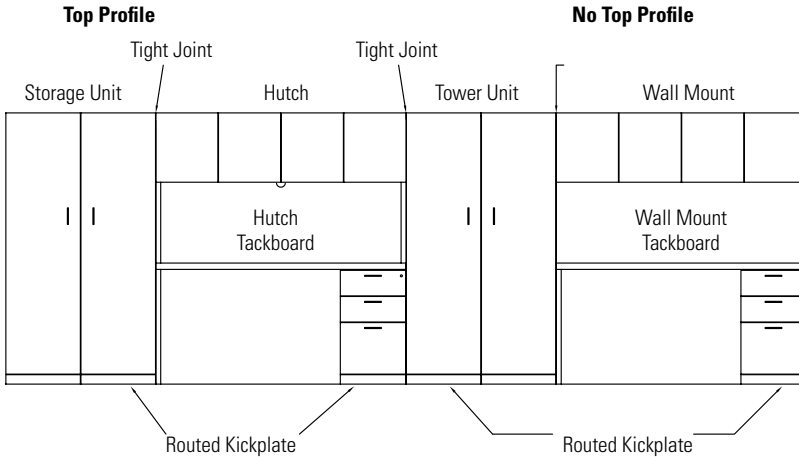

MODULAR PEDESTALS

- When using Storage Shells, laminate gables will show.
- Credenza shell cannot be completely filled up with storage shells to create a full storage credenza.
- Handle style must be specified.

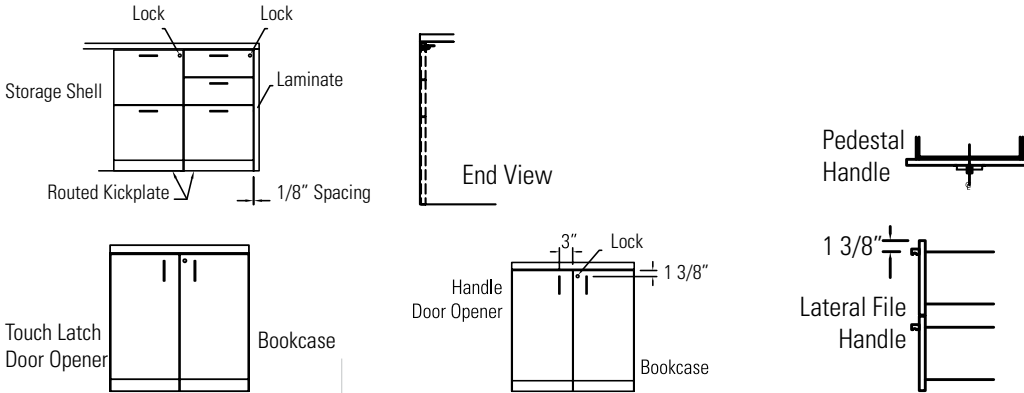

STORAGE SHELLS

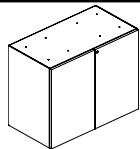

Storage Shell

	D x W x H				
LWG	18 x 35 x 28	92.5	115	11	\$1200
LWM	18 x 30 x 28	92.5	96	9	\$1080
LWG.5	18 x 34 x 28	92.5	115	11	\$1200

For use **under a freestanding worksurface (22", 24", 30" or 36"D)**. Top drilled to attach to worksurface. One adjustable shelf. Standard with lock.

- **Specify LWG and LWM for kneespace applications**
- **Unfinished top and back**

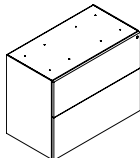

File/File Shell - Lateral

LWF	18 x 35 x 28	92.5	115	11	\$1694
LWN	18 x 30 x 28	92.5	96	9	\$1472
LWF.5	18 x 34 x 28	92.5	115	11	\$1694
LWN.5	18 x 29 x 28	92.5	96	9	\$1472

For use **under a freestanding worksurface (22", 24", 30" or 36"D)**. Top drilled to attach to worksurface. **Two lateral file drawers**. Lock secures all drawers. Front-to-back and side-to-side letter/legal filing capability. Side-to-side file bars included.

- **Specify LWF and LWN for kneespace applications**
- **Unfinished top and back**

Required Specifications

Veneer Finish
Edge

STORAGE SHELLS

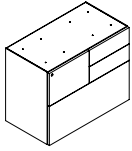

Mixed Storage Shell - LEFT

MODEL#	DIMENSIONS D x W x H	FREIGHT CLASS	WT/LBS.	CUBIC FT.	LIST PRICE
LWZL	18 x 35 x 28	92.5	115	11	\$1941
LWZL.5	18 x 34 x 28	92.5	115	11	\$1941

For use **under a freestanding worksurface (22", 24", 30" or 36"D)**. Top drilled to attach to worksurface. One file drawer on **left**, two box drawers on **right** and one lateral file drawer on bottom. File drawer and lateral file drawer lock. One pencil tray. Front-to-back and side-to-side filing. **Not for stacking materials on lateral file drawer bottom.**

- **Specify LWZL for kneespace applications**
- **Unfinished top and back**

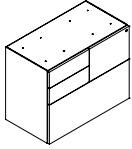

Mixed Storage Shell - RIGHT

LWZR	18 x 35 x 28	92.5	115	11	\$1941
LWZR.5	18 x 34 x 28	92.5	115	11	\$1941

For use **under a freestanding worksurface (22", 24", 30" or 36"D)**. Top drilled to attach to worksurface. One file drawer on **right**, two box drawers on **left** and one lateral file drawer on bottom. File drawer and lateral file drawer lock. One pencil tray. Front-to-back and side-to-side filing. **Not for stacking materials on lateral file drawer bottom.**

- **Specify LWZR for kneespace applications**
- **Unfinished top and back**

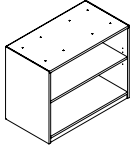

Open Shelving Shell

LWOB36	18 x 35 x 28	100	92	11	\$927
LWOB30	18 x 30 x 28	100	77	9	\$833

For use **under a freestanding worksurface (22", 24", 30" or 36"D)**. Top drilled to attach to worksurface. One adjustable veneer shelf.

- **Unfinished top and back**

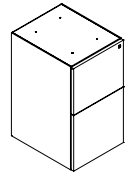

File/File Shell - Vertical

LETTER					
LWWE	23 x 16 x 28	92.5	72	6	\$1352
LWE	18 x 16 x 28	92.5	70	5	\$1200
LEGAL					
LWWLE	23 x 19 x 28	92.5	85	7	\$1581
LWLE	18 x 19 x 28	92.5	83	6	\$1400

For use **under a freestanding worksurface (22", 24", 30" or 36"D)**. Top drilled to attach to worksurface. **Two file drawers.** Lock secures all drawers.

- *For 22" or 24"D worksurface, order **LWE or LWLE**. For 30" or 36"D worksurface, order **LWWE or LWWLE**.*
- **Unfinished top and back**

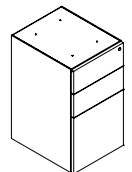

Box/Box/File Shell

LETTER					
LWWD	23 x 16 x 28	92.5	72	6	\$1352
LWD	19.1 x 16 x 28	92.5	70	5	\$1200
LEGAL					
LWWLD	23 x 19 x 28	92.5	85	7	\$1581
LWLD	19.1 x 19 x 28	92.5	83	6	\$1400

For use **under a freestanding worksurface (22", 24", 30" or 36"D)**. Top drilled to attach to worksurface. **Two box and one file drawers.** One pencil tray. Lock secures all drawers.

- *For 22" or 24"D worksurface, order **LWD or LWLD**. For 30" or 36"D worksurface, order **LWWD or LWWLD**.*
- **Unfinished top and back**

Required Specifications

Veneer Finish
Edge

STORAGE MODULES - FREESTANDING

MODEL# DIMENSIONS FREIGHT CLASS WT/LBS. CUBIC FT. LIST PRICE

D x W x H

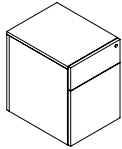

Box/File Freestanding Pedestal

LWBM	18 x 16 x 21	85	70	5	\$1000
LWWBM	24 x 16 x 21	85	75	6	\$1174

One box and one file drawer. One pencil tray. Lock secures all drawers. Finished back.

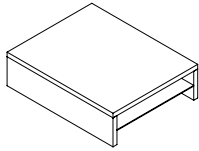

Spacer

LSPBOX1620	20 x 16 x 4.8	125	15	2	\$353
------------	---------------	-----	----	---	--------------

For use with 23" high credenzas to support an overlapping return. Includes shelf for paper management.

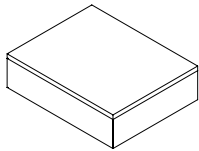

Spacer, Closed

LSPBOX1620C	20 x 16 x 4.8	125	15	2	\$390
-------------	---------------	-----	----	---	--------------

For use with 23" high credenzas to support an overlapping return.

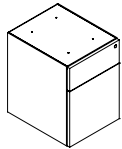

Box/File Pedestal

LWB15	18 x 16 x 19.5	70	50	3	\$855
-------	----------------	----	----	---	--------------

One box and one file drawer. One pencil tray. Lock secures all drawers. Finished back. **For use with 23" high credenza shell.**

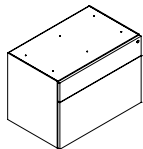

Box/Lateral File Pedestal

LWB36	18 x 36 x 19.5	92.5	115	11	\$1559
LWB30	18 x 30 x 19.5	92.5	96	9	\$1363

One box and one lateral file drawer. One pencil tray. Lock secures all drawers. Finished back. **For use with 23" high credenza shell.**

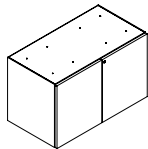

Storage Cabinet w/Doors

LWMH19.5	20 x 36 x 29	92.5	130	12	\$964
LWGH19.5	20 x 30 x 29	92.5	107	10	\$1087

Includes one adjustable shelf. Standard with lock. **For use with 23" high credenza shell.**

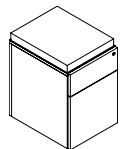

Box/File Freestanding Pedestal Mobile, with Cushion

LWBMCU	18 x 16 x 24	85	70	5	\$1236
LWWBMCU	24 x 16 x 24	85	75	6	\$1411

One box and one file drawer. One pencil tray. Lock secures all drawers. Casters.

Required Specifications

Veneer Finish
Edge

STORAGE MODULES - FREESTANDING

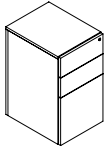

Box/Box/File Freestanding Pedestal

MODEL#	DIMENSIONS D x W x H	FREIGHT CLASS	WT/LBS.	CUBIC FT.	LIST PRICE
LWDB	18 x 16 x 28	85	70	5	\$1200
LWWDB	24 x 16 x 28	85	75	6	\$1381

Two box and one file drawer. One pencil tray. Lock secures all drawers. Finished back.

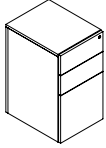

Box/Box/File Module, Mobile

LWDM	18 x 16 x 28	85	70	5	\$1291
LWWDM	24 x 16 x 28	85	75	6	\$1483

Two box and one file drawer. One pencil tray. Lock secures all drawers. Casters.

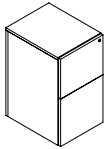

File/File Module, Mobile

LWEM	18 x 16 x 28	85	70	5	\$1400
LWWEM	24 x 16 x 28	85	75	6	\$1505

Two file drawer. Lock secures all drawers. Casters.

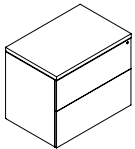

File/File Module, Lateral

LF3624	24 x 36 x 29	85	184	15	\$2216
LN3024	24 x 30 x 29	85	153	12	\$1941
LF3620	20 x 36 x 29	85	159	12	\$1665
LN3020	20 x 30 x 29	85	131	10	\$1454

Two lateral file drawers. Lock secures all drawers. Front-to-back letter and side-to-side letter/legal filing capability. Side-to-side file bars included.

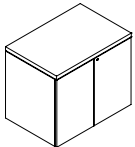

Storage Cabinet w/Doors

LBD3624	24 x 36 x 29	92.5	152	15	\$1508
LBD3024	24 x 30 x 29	92.5	127	12	\$1323
LBD3620	20 x 36 x 29	92.5	130	12	\$1189
LBD3020	20 x 30 x 29	92.5	107	10	\$1036

Includes one adjustable shelf. Standard with lock.

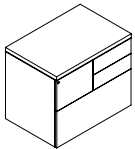

Mixed Storage Cabinet - LEFT

LZL3624	24 x 36 x 29	85	184	15	\$2406
LZL3620	20 x 36 x 29	85	170	13	\$1890

One file drawer on the **left**, two box drawers on the **right** and one lateral file drawer on the bottom. File drawer and lateral file drawer lock. One pencil tray. Front-to-back and side-to-side filing. Not for stacking materials on lateral file drawer bottom.

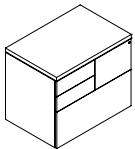

Mixed Storage Cabinet - RIGHT

LZR3624	24 x 36 x 29	85	184	15	\$2406
LZR3620	20 x 36 x 29	85	170	13	\$1890

One file drawer on the **right**, two box drawers on the **left** and one lateral file drawer on the bottom. File drawer and lateral file drawer lock. One pencil tray. Front-to-back and side-to-side filing. Not for stacking materials on lateral file drawer bottom.

Required Specifications

Veneer Finish
Edge

FREESTANDING STORAGE

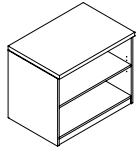

Open Storage Cabinet

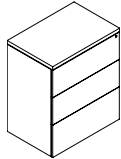

Three File Module

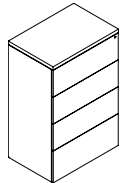

Four File Module

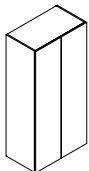

Storage Cabinet w/Doors

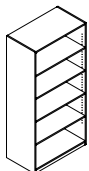

Open Storage Cabinet

MODEL# DIMENSIONS FREIGHT CLASS WT/LBS. CUBIC FT. LIST PRICE

D x W x H

LOB3624	24 x 36 x 29	100	123	15	\$1211
LOB3024	24 x 30 x 29	100	103	12	\$1058
LOB3620	20 x 36 x 29	100	115	13	\$952
LOB3020	20 x 30 x 29	100	96	11	\$829

One fixed and **one** adjustable veneer shelf. Shelves are ¾" thick.

LF36243	24 x 36 x 42	92.5	231	21	\$2711
LN30243	24 x 30 x 42	92.5	193	18	\$2369
LF36203	20 x 36 x 42	92.5	212	19	\$2318
LN30203	20 x 30 x 42	92.5	176	16	\$2028

Three lateral file drawers. Lock secures all drawers. Front-to-back letter and side-to-side letter/legal filing capability. Side-to-side file bars included.

LF36244	24 x 36 x 54	92.5	297	27	\$3303
LN30244	24 x 30 x 54	92.5	248	23	\$2889
LF36204	20 x 36 x 54	92.5	270	25	\$2874
LN30204	20 x 30 x 54	92.5	225	21	\$2515

Four lateral file drawers. Lock secures all drawers. Front-to-back letter and side-to-side letter/legal filing capability. Side-to-side file bars included.

L1D24H72	24 x 35 x 72	100	324	36	\$2885
L1D24W30H72	24 x 30 x 72	100	270	30	\$2518
L1D24W24H72	24 x 24 x 72	100	216	24	\$2151
L1H72	20 x 35 x 72	100	269	30	\$2518
L1W30H72	20 x 30 x 72	100	233	25	\$2101
L1W24H72	20 x 24 x 72	100	179	20	\$1679

L1D24	24 x 35 x 65	100	297	33	\$2646
L1D24W30	24 x 30 x 65	100	248	28	\$2315
L1D24W24	24 x 24 x 65	100	198	22	\$1984
L1W35	20 x 35 x 65	100	245	28	\$2311
L1W30	20 x 30 x 65	100	202	23	\$1926
L1W24	20 x 24 x 65	100	163	18	\$1541

Includes four adjustable shelves. Standard with lock.

L7D24H72	24 x 35 x 72	100	306	36	\$2311
L7D24W30H72	24 x 30 x 72	100	255	30	\$2021
L7H72	20 x 35 x 72	100	257	30	\$2017
L7W30H72	20 x 30 x 72	100	223	25	\$1679

L7D24	24 x 35 x 65	100	281	33	\$2119
L7D24W30	24 x 30 x 65	100	234	28	\$1853
L7	20 x 35 x 65	100	234	28	\$1850
L7W30	20 x 30 x 65	100	193	23	\$1541

Includes one fixed and **four** adjustable veneer shelves. Shelves are ¾" thick.

Required Specifications

- Veneer Finish
- Edge (file modules)

FREESTANDING STORAGE

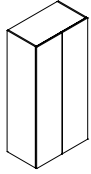

Wardrobe Cabinet

MODEL#	DIMENSIONS D x W x H	FREIGHT CLASS	WT/LBS.	CUBIC FT.	LIST PRICE
L2D24H72	24 x 35 x 72	100	324	36	\$2504
L2D24W30H72	24 x 30 x 72	100	270	30	\$2191
L2D24W24H72	24 x 24 x 72	100	216	24	\$1876
L2H72	20 x 35 x 72	100	269	30	\$2188
L2W30H72	20 x 30 x 72	100	233	25	\$1825
L2W24H72	20 x 24 x 72	100	179	20	\$1457
L2D24	24 x 35 x 65	100	297	33	\$2296
L2D24W30	24 x 30 x 65	100	246	28	\$2010
L2D24W24	24 x 24 x 65	100	198	22	\$1723
L2	20 x 35 x 65	100	245	28	\$2002
L2W30	20 x 30 x 65	100	202	23	\$1672
L2W24	20 x 24 x 65	100	163	18	\$1338

Includes full length hanging rod and fixed hat shelf.

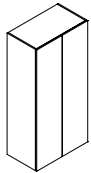

Wardrobe Cabinet/Shelving Combo

L25D24H72	24 x 35 x 72	100	324	36	\$3237
L25D24W30H72	24 x 30 x 72	100	270	30	\$2831
L25D24W24H72	24 x 24 x 72	100	216	24	\$2424
L25H72	20 x 35 x 72	100	269	30	\$2823
L25W30H72	20 x 30 x 72	100	233	25	\$2355
L25W24H72	20 x 24 x 72	100	179	20	\$1886
L25D24	24 x 35 x 65	100	297	33	\$2969
L25D24W30	24 x 30 x 65	100	246	28	\$2595
L25D24W24	24 x 24 x 65	100	198	22	\$2224
L25	20 x 35 x 65	100	245	28	\$2587
L25W30	20 x 30 x 65	100	202	23	\$2159
L25W24	20 x 24 x 65	100	163	18	\$1730

Wardrobe compartment on **left** includes hanging rod and fixed hat shelf. Storage compartment on **right** includes three adjustable shelves.

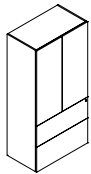

Two File Module w/Doors

L13D24H72	24 x 35 x 72	100	324	36	\$3571
L13D24W30H72	24 x 30 x 72	100	270	30	\$3125
L13H72	20 x 35 x 72	100	269	30	\$3117
L13W30H72	20 x 30 x 72	100	233	25	\$2601
L13D24	24 x 35 x 65	100	297	33	\$3274
L13D24W30	24 x 30 x 65	100	248	28	\$2863
L13	20 x 35 x 65	100	245	28	\$2860
L13W30	20 x 30 x 65	100	202	23	\$2384

Two lateral file drawers on bottom. Includes **two** adjustable shelves. Upper lock secures storage compartment. Lower lock secures two file drawers. Front-to-back and side-to-side filing. **Not for stacking materials on lateral file drawer bottom.**

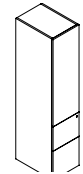

Two File Module w/Door - LEFT

L17D24H72L	24 x 16 x 72	125	99	15	\$2456
L17H72L	20 x 16 x 72	125	90	13	\$2090
L17D24L	24 x 16 x 65	125	91	13	\$2278
L17L	20 x 16 x 65	125	83	12	\$1916

Two file drawers on bottom. Includes two adjustable shelves. Upper lock secures storage compartment. Lower lock secures two file drawers. Handle is on the **right**, door opens to the **left**.

Required Specifications

Veneer Finish

FREESTANDING STORAGE

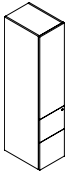

Two File Module w/Door - RIGHT

MODEL#	D x W x H	DIMENSIONS	FREIGHT CLASS	WT/LBS.	CUBIC FT.	LIST PRICE
L17D24H72R	24 x 16 x 72	24 x 16 x 72	125	99	15	\$2456
L17H72R	20 x 16 x 72	20 x 16 x 72	125	90	13	\$2090
L17D24R	24 x 16 x 65	24 x 16 x 65	125	91	13	\$2278
L17R	20 x 16 x 65	20 x 16 x 65	125	83	12	\$1916

Two file drawers on bottom. Includes two adjustable shelves. Upper lock secures storage compartment. Lower lock secures two file drawers. Handle is on the **left**, door opens to the **right**.

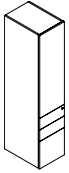

Box/Box/File Module w/Door - LEFT

L18D24H72L	24 x 16 x 72	24 x 16 x 72	125	99	15	\$2456
L18H72L	20 x 16 x 72	20 x 16 x 72	125	90	13	\$2090
L18D24L	24 x 16 x 65	24 x 16 x 65	125	91	13	\$2278
L18L	20 x 16 x 65	20 x 16 x 65	125	83	12	\$1916

Two box drawers and one file drawer on bottom. Includes two adjustable shelves. Upper lock secures storage compartment. Lower lock secures all drawers. Handle is on the **right**, door opens to the **left**.

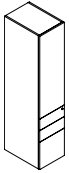

Box/Box/File Module w/Door - RIGHT

L18D24H72R	24 x 16 x 72	24 x 16 x 72	125	99	15	\$2456
L18H72R	20 x 16 x 72	20 x 16 x 72	125	90	13	\$2090
L18D24R	24 x 16 x 65	24 x 16 x 65	125	91	13	\$2278
L18R	20 x 16 x 65	20 x 16 x 65	125	83	12	\$1916

Two box drawers and one file drawer on bottom. Includes two adjustable shelves. Upper lock secures storage compartment. Lower lock secures all drawers. Handle is on the **left**, door opens to the **right**.

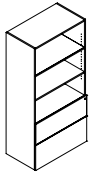

Two File Module w/Open Shelves

L12D24H72	24 x 35 x 72	24 x 35 x 72	100	324	36	\$3136
L12D24W30H72	24 x 30 x 72	24 x 30 x 72	100	270	30	\$2743
L12H72	20 x 35 x 72	20 x 35 x 72	100	269	30	\$2736
L12W30H72	20 x 30 x 72	20 x 30 x 72	100	233	25	\$2395
L12D24	24 x 35 x 65	24 x 35 x 65	100	297	33	\$2874
L12D24W30	24 x 30 x 65	24 x 30 x 65	100	248	28	\$2515
L12	20 x 35 x 65	20 x 35 x 65	100	245	28	\$2507
L12W30	20 x 30 x 65	20 x 30 x 65	100	239	23	\$2093

Three open veneer shelves and two lateral file drawers on bottom. Includes two adjustable shelves. Lock secures all drawers. Front-to-back and side-to-side filing. **Not for stacking materials on lateral file drawer bottom.**

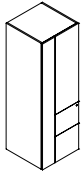

Personal Tower - LEFT

L29D24W24H72L	24 x 24 x 72	24 x 24 x 72	125	168	24	\$3655
L29W24H72L	20 x 24 x 72	20 x 24 x 72	125	140	20	\$2987
L29D24W24L	24 x 24 x 65	24 x 24 x 65	125	154	22	\$3281
L29W24L	20 x 24 x 65	20 x 24 x 65	125	128	18	\$2707

Two file drawers on bottom. Wardrobe compartment on **left** includes hanging rod. Storage compartment on **right** includes one adjustable shelf. Upper lock secures storage and wardrobe compartments. Lower lock secures all drawers.

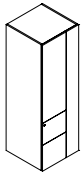

Personal Tower - RIGHT

L29D24W24H72R	24 x 24 x 72	24 x 24 x 72	125	168	24	\$3655
L29W24H72R	20 x 24 x 72	20 x 24 x 72	125	140	20	\$2987
L29D24W24R	24 x 24 x 65	24 x 24 x 65	125	154	22	\$3281
L29W24R	20 x 24 x 65	20 x 24 x 65	125	128	18	\$2707

Two file drawers on bottom. Wardrobe compartment on **right** includes hanging rod. Storage compartment on **left** includes one adjustable shelf. Upper lock secures storage and wardrobe compartments. Lower lock secures all drawers.

Required Specifications

Veneer Finish

FREESTANDING STORAGE

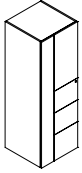

Personal Tower - LEFT

MODEL#	DIMENSIONS D x W x H	FREIGHT CLASS	WT/LBS.	CUBIC FT.	LIST PRICE
L27D24W24H72L	24 x 24 x 72	125	168	24	\$4033
L27W24H72L	20 x 24 x 72	125	140	20	\$3525
L27D24W24L	24 x 24 x 65	125	154	22	\$3699
L27W24L	20 x 24 x 65	125	128	18	\$3230

Three file drawers on bottom. Wardrobe compartment on **left** includes hanging rod. Storage compartment on **right** includes one adjustable shelf. Upper lock secures storage and wardrobe compartments. Lower lock secures all drawers.

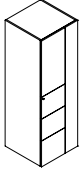

Personal Tower - RIGHT

L27D24W24H72R	24 x 24 x 72	125	168	24	\$4033
L27W24H72R	20 x 24 x 72	125	140	20	\$3525
L27D24W24R	24 x 24 x 65	125	154	22	\$3699
L27W24R	20 x 24 x 65	125	128	18	\$3230

Three file drawers on bottom. Wardrobe compartment on **right** includes hanging rod. Storage compartment on **left** includes one adjustable shelf. Upper lock secures storage and wardrobe compartments. Lower lock secures all drawers.

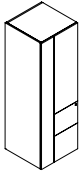

Personal Tower w/Open Bookcase - LEFT

L30D24W24H72L	24 x 24 x 72	125	168	24	\$3655
L30W24H72L	20 x 24 x 72	125	140	20	\$2987
L30D24W24L	24 x 24 x 65	125	154	22	\$3281
L30W24L	20 x 24 x 65	125	128	18	\$2707

Two file drawers on bottom. Wardrobe compartment on **left** includes hanging rod. Storage compartment on **right** includes one adjustable shelf. Open bookcase on **right** includes two adjustable shelves. Upper lock secures storage and wardrobe compartments. Lower lock secures all drawers.

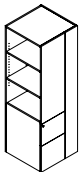

Personal Tower w/Open Bookcase - RIGHT

L30D24W24H72R	24 x 24 x 72	125	168	24	\$3655
L30W24H72R	20 x 24 x 72	125	140	20	\$2987
L30D24W24R	24 x 24 x 65	125	154	22	\$3281
L30W24R	20 x 24 x 65	125	128	18	\$2707

Two file drawers on bottom. Wardrobe compartment on **right** includes hanging rod. Storage compartment on **left** includes one adjustable shelf. Open bookcase on **left** includes two adjustable shelves. Upper lock secures storage and wardrobe compartments. Lower lock secures all drawers.

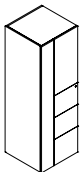

Personal Tower w/Open Bookcase - LEFT

L26D24W24H72L	24 x 24 x 72	125	168	24	\$4033
L26W24H72L	20 x 24 x 72	125	140	20	\$3993
L26D24W24L	24 x 24 x 65	125	154	22	\$3699
L26W24L	20 x 24 x 65	125	128	18	\$3688

Three file drawers on bottom. Wardrobe compartment on **left** includes hanging rod. Storage compartment on **right** includes one adjustable shelf. Open bookcase on **right** includes one adjustable shelf. Upper lock secures storage and wardrobe compartments. Lower lock secures all drawers.

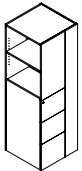

Personal Tower w/Open Bookcase - RIGHT

L26D24W24H72R	24 x 24 x 72	125	168	24	\$4033
L26W24H72R	20 x 24 x 72	125	140	20	\$3993
L26D24W24R	24 x 24 x 65	125	154	22	\$3699
L26W24R	20 x 24 x 65	125	128	18	\$3688

Three file drawers on bottom. Wardrobe compartment on **right** includes hanging rod. Storage compartment on **left** includes one adjustable shelf. Open bookcase on **left** includes one adjustable shelf. Upper lock secures storage and wardrobe compartments. Lower lock secures all drawers.

Required Specifications

Veneer Finish

FREESTANDING STORAGE

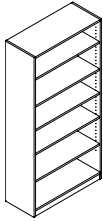

Bookcase

MODEL#	DIMENSIONS D x W x H	FREIGHT CLASS	WT/LBS.	CUBIC FT.	LIST PRICE
LB73615	15 x 35 x 78	100	228	24	\$1643
LB63615	15 x 35 x 72	100	210	23	\$1516
LB53615	15 x 35 x 65	100	210	23	\$1396
LB73015	15 x 30 x 78	92.5	228	20	\$1436
LB63015	15 x 30 x 72	92.5	210	19	\$1323
LB53015	15 x 30 x 65	92.5	188	17	\$1221

Includes **adjustable** shelves. Shelf is 3/4" thick.



End Shelf - 72" High - Square

LB7S1515	15 x 15 x 78	100	95	10	\$1294
LB6S1515	15 x 15 x 72	100	83	9	\$1192
LB5S1515	15 x 15 x 65	100	81	9	\$1098
LB4S1515	15 x 15 x 48	100	59	6	\$906

For use at end of **storage modules, wardrobe cabinets or personal towers**. Includes **adjustable** veneer shelves. Shipped RTA (ready to assemble).

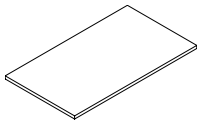

Shelf for Bookcase

MAG3624	24 x 35 x 1	92.5	112	10	\$114
MAG3620	20 x 35 x 1	92.5	92	9	\$96
MAG3615	15 x 35 x 1	92.5	81	8	\$81
MAG3024	24 x 30 x 1	92.5	94	9	\$96
MAG3020	20 x 30 x 1	100	76	8	\$77
MAG3015	15 x 30 x 1	100	67	8	\$66

WALLMOUNT STORAGE

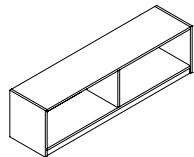

Open Front Overhead Storage

CSF072	15 x 72 x 17	92.5	100	10	\$1243
CSF066	15 x 66 x 17	100	83	9	\$1141
CSF060	15 x 60 x 17	100	75	8	\$1040
CSF054	15 x 54 x 17	100	68	7	\$938
CSF048	15 x 48 x 17	100	60	7	\$833
CSF042	15 x 42 x 17	100	55	6	\$767
CSF036	15 x 36 x 17	92.5	50	5	\$756
CSF030	15 x 30 x 17	92.5	45	4	\$742

Includes pre-mounted "J" brackets for wall mount applications.

- **NOTE:** Care should be taken to mount the units. Units should be mounted to wall studs using correct fasteners. Failure to do so may result in collapse of the unit and subsequent personal injury. **Mounting hardware not included.** Mounting hardware used should be based on wall material. Consult an installation professional for proper wall mounting.

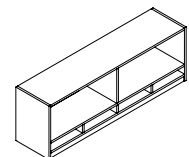

Open Front Overhead Storage - Pigeon-Hole Storage

CSFOP72	15 x 72 x 20	92.5	100	12	\$1494
CSFOP66	15 x 66 x 20	100	83	11	\$1371
CSFOP60	15 x 60 x 20	100	75	10	\$1247
CSFOP54	15 x 54 x 20	100	68	9	\$1123
CSFOP48	15 x 48 x 20	100	60	8	\$996
CSFOP42	15 x 42 x 20	100	55	7	\$935
CSFOP36	15 x 36 x 20	92.5	50	6	\$909
CSFOP30	15 x 30 x 20	92.5	45	5	\$895

Includes pre-mounted "J" brackets for wall mount applications. Horizontal pigeon-hole storage on bottom of overhead.

- **NOTE:** Care should be taken to mount the units. Units should be mounted to wall studs using correct fasteners. Failure to do so may result in collapse of the unit and subsequent personal injury. **Mounting hardware not included.** Mounting hardware used should be based on wall material. Consult an installation professional for proper wall mounting.

Required Specifications

Veneer Finish

HUTCHES

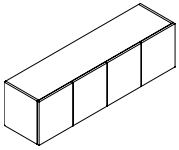

Closed Front Overhead Storage with Hinge Doors

MODEL#	DIMENSIONS D x W x H	FREIGHT CLASS	WT/LBS.	CUBIC FT.	LIST PRICE
CSF72	15 x 72 x 17	92.5	100	10	\$1534
CSF66	15 x 66 x 17	100	83	9	\$1406
CSF60	15 x 60 x 17	100	75	8	\$1275
CSF54	15 x 54 x 17	100	68	7	\$1149
CSF48	15 x 48 x 17	100	60	7	\$1021
CSF42	15 x 42 x 17	100	55	6	\$938
CSF36	15 x 36 x 17	92.5	50	5	\$920
CSF30	15 x 30 x 17	92.5	45	4	\$906

Includes pre-mounted "J" brackets for wall mount applications.

- **NOTE:** Care should be taken to mount the units. Units should be mounted to wall studs using correct fasteners. Failure to do so may result in collapse of the unit and subsequent personal injury. **Mounting hardware not included.** Mounting hardware used should be based on wall material. Consult an installation professional for proper wall mounting.

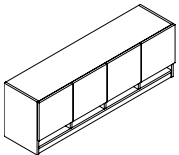

Closed Front Overhead Storage with Hinge Doors & Pigeon-Hole Storage

CSFP72	15 x 72 x 20	92.5	100	12	\$1839
CSFP66	15 x 66 x 20	100	83	11	\$1686
CSFP60	15 x 60 x 20	100	75	10	\$1534
CSFP54	15 x 54 x 20	100	68	9	\$1381
CSFP48	15 x 48 x 20	100	60	8	\$1225
CSFP42	15 x 42 x 20	100	55	7	\$1163
CSFP36	15 x 36 x 20	92.5	50	6	\$1105
CSFP30	15 x 30 x 20	92.5	45	5	\$1087

Includes pre-mounted "J" brackets for wall mount applications. Horizontal pigeon-hole storage on bottom of overhead.

- **NOTE:** Care should be taken to mount the units. Units should be mounted to wall studs using correct fasteners. Failure to do so may result in collapse of the unit and subsequent personal injury. **Mounting hardware not included.** Mounting hardware used should be based on wall material. Consult an installation professional for proper wall mounting.

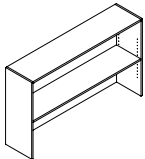

Open Hutch with Closed Back

L72CL36	14 x 72 x 36	125	155	23	\$1392
L66CL36	14 x 66 x 36	125	140	21	\$1291
L60CL36	14 x 60 x 36	125	130	19	\$1145
L48CL36	14 x 48 x 36	125	110	15	\$1091
L42CL36	14 x 42 x 36	125	95	13	\$989
L36CL36	14 x 36 x 36	125	80	11	\$924
L30CL36	14 x 30 x 36	125	67	9	\$771

One adjustable shelf. Closed back. All hutches shipped pre-assembled.

- **A Tackboard cannot be used with this hutch.**

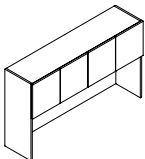

Closed Hutch w/Veneer Doors 36" High

L108SH36	15 x 108 x 36	125	268	34	\$3390
L102SH36	15 x 102 x 36	125	254	32	\$3201
L96SH36	15 x 96 x 36	100	241	30	\$3012
L90SH36	15 x 90 x 36	100	227	28	\$2823
L84SH36	15 x 84 x 36	100	214	26	\$2638
L78SH36	15 x 78 x 36	100	200	24	\$2449
L72SH36	15 x 72 x 36	100	187	23	\$2261
L66SH36	15 x 66 x 36	100	173	21	\$2176
L60SH36	15 x 60 x 36	100	160	19	\$2071
L36SH36	15 x 36 x 36	100	94	11	\$1414
L30SH36	15 x 30 x 36	100	78	9	\$1236

One fixed shelf. Closed back features one grommet. All hutches shipped pre-assembled.

- Models 108" w have three fixed shelf dividers.
- Models 84" w - 102" w have two fixed shelf dividers.
- Models 60" w - 78" w have one fixed shelf divider.
- *Clearance from worksurface to valance is 19.5".*

Required Specifications

Veneer Finish

HUTCHES

MODEL# DIMENSIONS FREIGHT CLASS WT/LBS. CUBIC FT. LIST PRICE

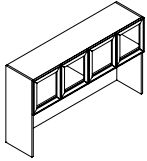

Closed Hutch w/Glass Doors 36" High

	D x W x H					
L108SH36G	15 x 108 x 36	125	268	34	\$4952	
L102SH36G	15 x 102 x 36	125	254	32	\$4469	
L96SH36G	15 x 96 x 36	100	241	30	\$4262	
L90SH36G	15 x 90 x 36	100	227	28	\$4041	
L84SH36G	15 x 84 x 36	100	214	26	\$3833	
L78SH36G	15 x 78 x 36	100	200	24	\$3626	
L72SH36G	15 x 72 x 36	100	187	23	\$3165	
L66SH36G	15 x 66 x 36	100	173	21	\$3031	
L60SH36G	15 x 60 x 36	100	160	19	\$2892	
L36SH36G	15 x 36 x 36	100	94	11	\$1850	
L30SH36G	15 x 30 x 36	100	78	9	\$1650	

One fixed shelf. Closed back features one grommet. Aluminum frame available in Tungsten finish only. All hutches shipped pre-assembled. Translucent, screened glass.

- Models 108" w have three fixed shelf dividers.
- Models 84" w- 102" w have two fixed shelf dividers.
- Models 60" w - 78" w have one fixed shelf divider.
- Clearance from worksurface to valance is 19.5".
- Locks are not available on hutches with Glass Doors.

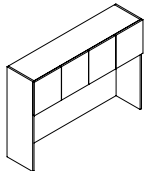

Closed Hutch w/Veneer Doors 42" H

L108SH42	15 x 108 x 42	125	307	39	\$3953	
L102SH42	15 x 102 x 42	125	290	37	\$3731	
L96SH42	15 x 96 x 42	100	273	35	\$3514	
L90SH42	15 x 90 x 42	100	256	33	\$3292	
L84SH42	15 x 84 x 42	100	239	31	\$3074	
L78SH42	15 x 78 x 42	100	222	38	\$2856	
L72SH42	15 x 72 x 42	100	205	26	\$2635	
L66SH42	15 x 66 x 42	100	188	24	\$2540	
L60SH42	15 x 60 x 42	100	171	22	\$2416	
L36SH42	15 x 36 x 42	100	102	13	\$1646	
L30SH42	15 x 30 x 42	100	85	11	\$1443	

One fixed shelf. Closed back features one grommet. All hutches shipped pre-assembled.

- Models 108" w have three fixed shelf dividers.
- Models 84" w- 102" w have two fixed shelf dividers.
- Models 60" w - 78" w have one fixed shelf divider.
- Clearance from worksurface to valance is 19.5".

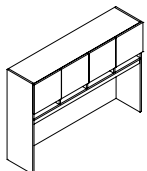

Closed Hutch w/Veneer Doors Pigeon-Hole Storage, 42" High

L108SHP42	15 x 108 x 42	125	307	39	\$4745	
L102SHP42	15 x 102 x 42	125	290	37	\$4480	
L96SHP42	15 x 96 x 42	100	273	35	\$4215	
L90SHP42	15 x 90 x 42	100	256	33	\$3953	
L84SHP42	15 x 84 x 42	100	239	31	\$3688	
L78SHP42	15 x 78 x 42	100	222	38	\$3426	
L72SHP42	15 x 72 x 42	100	205	26	\$3161	
L66SHP42	15 x 66 x 42	100	188	24	\$3045	
L60SHP42	15 x 60 x 42	100	171	22	\$2900	
L36SHP42	15 x 36 x 42	100	102	13	\$1977	
L30SHP42	15 x 30 x 42	100	85	11	\$1730	

One fixed shelf. Closed back features one grommet. Horizontal pigeon-hole storage top mounted to hutch. All hutches shipped pre-assembled.

- Models 120" w- 108" w have three fixed shelf dividers.
- Models 84" w- 102" w have two fixed shelf dividers.
- Models 60" w - 78" w have one fixed shelf divider.
- Clearance from worksurface to valance is 21.5".

Required Specifications

Veneer Finish

HUTCHES

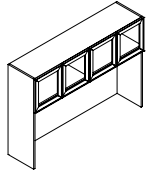

Closed Hutch w/Glass Doors 42" High

MODEL#	DIMENSIONS D x W x H	FREIGHT CLASS	WT/LBS.	CUBIC FT.	LIST PRICE
L108SH42G	15 x 108 x 42	125	307	39	\$5217
L102SH42G	15 x 102 x 42	125	290	37	\$4709
L96SH42G	15 x 96 x 42	100	273	35	\$4483
L90SH42G	15 x 90 x 42	100	256	33	\$4258
L84SH42G	15 x 84 x 42	100	239	31	\$4033
L78SH42G	15 x 78 x 42	100	222	38	\$3811
L72SH42G	15 x 72 x 42	100	205	26	\$3288
L66SH42G	15 x 66 x 42	100	188	24	\$3176
L60SH42G	15 x 60 x 42	100	171	22	\$3060
L36SH42G	15 x 36 x 42	100	102	13	\$1955
L30SH42G	15 x 30 x 42	100	85	11	\$1737

One fixed shelf. Closed back features one grommet. Aluminum frame available in Tungsten finish only. All hutches shipped pre-assembled. Translucent, screened glass.

- Models 120" w- 108" w have three fixed shelf dividers.
- Models 84" w- 102" w have two fixed shelf dividers.
- Models 60" w - 78" w have one fixed shelf divider.
- *Clearance from worksurface to valance is 25.5"*.
- **Locks are not available on hutches with Glass Doors.**

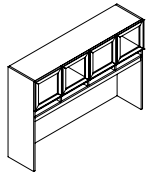

Closed Hutch w/Glass Doors Pigeon-Hole Storage, 42" High

L108SHP42G	15 x 108 x 42	125	307	39	\$5936
L102SHP42G	15 x 102 x 42	125	290	37	\$5388
L96SHP42G	15 x 96 x 42	100	273	35	\$5134
L90SHP42G	15 x 90 x 42	100	256	33	\$5214
L84SHP42G	15 x 84 x 42	100	239	31	\$4585
L78SHP42G	15 x 78 x 42	100	222	38	\$4324
L72SHP42G	15 x 72 x 42	100	205	26	\$3768
L66SHP42G	15 x 66 x 42	100	188	24	\$3644
L60SHP42G	15 x 60 x 42	100	171	22	\$3474
L36SHP42G	15 x 36 x 42	100	102	13	\$2256
L30SHP42G	15 x 30 x 42	100	85	11	\$2013

One fixed shelf. Closed back features one grommet. Aluminum frame available in Tungsten finish only. Horizontal pigeon-hole storage top mounted to hutch. All hutches shipped pre-assembled. Translucent, screened glass.

- Models 120" w- 108" w have three fixed shelf dividers.
- Models 84" w- 102" w have two fixed shelf dividers.
- Models 60" w - 78" w have one fixed shelf divider.
- *Clearance from worksurface to valance is 21.5"*.
- **Locks are not available on hutches with Glass Doors.**

TACKBOARDS FOR HUTCHES AND OVERHEAD STORAGE

TACKBOARD Notes: Tackboards can be upholstered in all of the following fabrics:

Grade 1: Agate II, Drama, Jenny, Pebbles, Quilt, Sprinkle, Station, Urban

Grade 2: Crescent, Cumulus, Imprint, Lola, Match, Oxygen, Quantum, Renewal, Replay, Silhouette

Grade 3: Brinx, Couture, Mariposa

Grade 4: Accent

Grade 5: Meander, Tracery, Universe

Required Specifications

Veneer Finish
Fabric (Tackboard)

TACKBOARDS FOR OVERHEAD STORAGE

MODEL#	DIMENSIONS	FREIGHT CLASS	WT/LBS.	CUBIC FT.	GR. 1-3	GR. 4-5
D x W x H						
LTS108	1 x 108 x 20	92.5	23	2	\$601	\$752
LTS102	1 x 102 x 20	100	19	2	\$567	\$709
LTS96	1 x 96 x 20	70	17	1	\$535	\$669
LTS90	1 x 90 x 20	70	15	1	\$502	\$628
LTS84	1 x 84 x 20	85	14	1	\$470	\$588
LTS78	1 x 78 x 20	85	13	1	\$433	\$542
LTS72	1 x 72 x 20	85	12	1	\$401	\$502
LTS66	1 x 66 x 20	92.5	11	1	\$364	\$455
LTS60	1 x 60 x 20	92.5	10	1	\$335	\$419
LTS36	1 x 36 x 20	125	8	1	\$201	\$252
LTS30	1 x 30 x 20	150	5	1	\$168	\$210

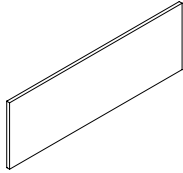

Tackboard for Hutch

For use on **36" H** hutches (**L_SH36, L_SH36G**). **Factory installed**, with velcro tape. Please specify hutch to be installed on. See *Tackboard Notes* above for exact fabric availability.

LTS108H26	1 x 108 x 26	70	30	2	\$782	\$978
LTS102H26	1 x 102 x 26	85	24	2	\$738	\$923
LTS96H26	1 x 96 x 26	92.5	22	2	\$695	\$869
LTS90H26	1 x 90 x 26	92.5	20	2	\$655	\$819
LTS84H26	1 x 84 x 26	100	18	2	\$607	\$759
LTS78H26	1 x 78 x 26	100	17	2	\$564	\$705
LTS72H26	1 x 72 x 26	70	16	1	\$521	\$652
LTS66H26	1 x 66 x 26	85	14	1	\$476	\$595
LTS60H26	1 x 60 x 26	85	13	1	\$433	\$542
LTS36H26	1 x 36 x 26	100	8	1	\$262	\$328
LTS30H26	1 x 30 x 26	150	5	1	\$219	\$274

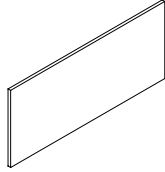

Tackboard for Hutch

For use on **42" H** hutches (**L_SH42, L_SH42**). **Factory installed**, with velcro tape. Please specify hutch to be installed on. See *Tackboard Notes* above for exact fabric availability.

LTSP108H23	1 x 108 x 23	70	30	2	\$676	\$845
LTSP102H23	1 x 102 x 23	85	24	2	\$647	\$647
LTSP96H23	1 x 96 x 23	92.5	20	2	\$604	\$755
LTSP90H23	1 x 90 x 23	92.5	20	1	\$567	\$709
LTSP84H23	1 x 84 x 23	70	18	1	\$527	\$527
LTSP78H23	1 x 78 x 23	70	17	1	\$491	\$614
LTSP72H23	1 x 72 x 23	70	16	1	\$455	\$569
LTSP66H23	1 x 66 x 23	85	14	1	\$415	\$519
LTSP60H23	1 x 60 x 23	85	13	1	\$345	\$345
LTSP36H23	1 x 36 x 23	100	8	1	\$226	\$283
LTSP30H23	1 x 30 x 23	150	5	1	\$190	\$238

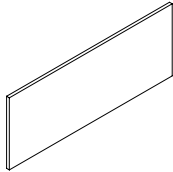

Tackboard for Hutch

For use on **42" H** hutches (**L_SHP42, L_SHP42G**) with Pigeon-Hole Storage. **Factory installed**, with velcro tape. Please specify hutch to be installed on. See *Tackboard Notes* above for exact fabric availability.

LTSAS108	1 x 108 x 20	92.5	23	2	\$1066	\$1333
LTSAS102	1 x 102 x 20	100	19	2	\$960	\$1200
LTSAS96	1 x 96 x 20	70	15	1	\$946	\$1183
LTSAS90	1 x 90 x 20	70	15	1	\$887	\$1109
LTSAS84	1 x 84 x 20	85	14	1	\$829	\$1037
LTSAS78	1 x 78 x 20	85	13	1	\$771	\$964
LTSAS72	1 x 72 x 20	85	12	1	\$709	\$887
LTSAS66	1 x 66 x 20	92.5	11	1	\$651	\$814
LTSAS60	1 x 60 x 20	92.5	10	1	\$593	\$742
LTSAS36	1 x 36 x 20	125	6	1	\$353	\$442
LTSAS30	1 x 30 x 20	150	4	1	\$295	\$369

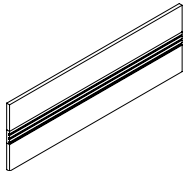

Tackboard for Hutch - Accessory Rail

For use on **36" H** hutches (**L_SH36, L_SH36G**). **Factory installed**, with velcro tape. Please specify hutch to be installed on. See *Tackboard Notes* above for exact fabric availability.

- **Must Specify Black (E) or Tungsten (K) Accessory Rail finish.**

Required Specifications

Fabric

TACKBOARDS FOR OVERHEAD STORAGE

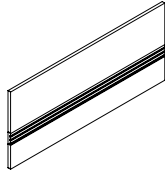

Tackboard for Hutch - Accessory Rail

MODEL#	DIMENSIONS D x W x H	FREIGHT CLASS	WT/LBS.	CUBIC FT.	GR. 1-3	GR. 4-5
LTSAS108H26	1 x 108 x 26	70	23	2	\$1283	\$1604
LTSAS102H26	1 x 102 x 26	85	19	2	\$1207	\$1509
LTSAS96H26	1 x 96 x 26	92.5	15	1	\$1138	\$1423
LTSAS90H26	1 x 90 x 26	92.5	15	1	\$1069	\$1337
LTSAS84H26	1 x 84 x 26	100	14	1	\$986	\$1233
LTSAS78H26	1 x 78 x 26	100	13	1	\$924	\$1155
LTSAS72H26	1 x 72 x 26	70	12	1	\$840	\$1050
LTSAS66H26	1 x 66 x 26	85	11	1	\$782	\$978
LTSAS60H26	1 x 60 x 26	85	10	1	\$709	\$887
LTSAS36H26	1 x 36 x 26	100	6	1	\$425	\$532
LTSAS30H26	1 x 30 x 26	150	4	1	\$357	\$447

For use on **42"H** hutches (**L_SH42, L_SH42G**). **Factory installed**, with velcro tape. Please specify hutch to be installed on. See *Tackboard Notes* above for exact fabric availability.

- **Must Specify Black (E) or Tungsten (K) Accessory Rail finish.**

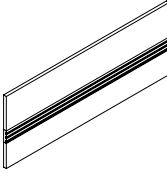

Tackboard for Hutch - Accessory Rail

LTSPAS108H23	1 x 108 x 23	92.5	30	2	\$1156	\$1445
LTSPAS102H23	1 x 102 x 23	100	24	2	\$1443	\$1804
LTSPAS96H23	1 x 96 x 23	70	20	2	\$1029	\$1287
LTSPAS90H23	1 x 90 x 23	70	20	2	\$967	\$1209
LTSPAS84H23	1 x 84 x 23	85	18	2	\$901	\$1127
LTSPAS78H23	1 x 78 x 23	85	17	2	\$836	\$1045
LTSPAS72H23	1 x 72 x 23	85	16	1	\$771	\$964
LTSPAS66H23	1 x 66 x 23	92.5	14	1	\$709	\$887
LTSPAS60H23	1 x 60 x 23	92.5	13	1	\$644	\$805
LTSPAS36H23	1 x 36 x 23	125	6	1	\$386	\$483
LTSPAS30H23	1 x 30 x 23	150	4	1	\$324	\$405

For use on **42"H** hutches (**L_SHP42, L_SHP42G**) with Pigeon-Hole Storage. **Factory installed**, with velcro tape. Please specify hutch to be installed on. See *Tackboard Notes* above for exact fabric availability. List Price shown applies for all fabric grades.

- **Must Specify Black (E) or Tungsten (K) Accessory Rail finish.**

WALLMOUNT TACKBOARDS

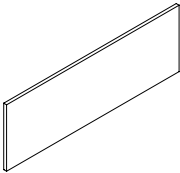

Tackboard - Wallmounted

TS108	1 x 106 x 19	70	23	2	\$829	\$1037
TS102	1 x 100 x 19	85	19	2	\$786	\$982
TS96	1 x 94 x 19	70	15	1	\$734	\$918
TS90	1 x 88 x 19	70	15	1	\$690	\$863
TS84	1 x 82 x 19	70	14	1	\$647	\$809
TS78	1 x 76 x 19	70	13	1	\$599	\$749
TS72	1 x 70 x 19	70	12	1	\$375	\$469
TS66	1 x 64 x 19	85	11	1	\$345	\$432
TS60	1 x 58 x 19	85	10	1	\$316	\$396
TS36	1 x 34 x 19	100	6	1	\$201	\$252
TS30	1 x 28 x 19	150	4	1	\$167	\$209

For use on **16.5"H** overhead storage (**CSFO_, CSF_, CSFF_**) at a finished height of **66"**. See *Tackboard Notes* above for exact fabric availability. List Price shown applies for all fabric grades.

- **NOTE:** Care should be taken to mount the units. Units should be mounted to wall studs using correct fasteners. Failure to do so may result in collapse of the unit and subsequent personal injury. **Mounting hardware not included.** Mounting hardware used should be based on wall material. Consult an installation professional for proper wall mounting.

Required Specifications

Fabric

WALLMOUNT TACKBOARDS

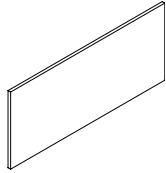

Tackboard - Wallmounted

MODEL#	DIMENSIONS	FREIGHT CLASS	WT/LBS.	CUBIC FT.	GR. 1-3	GR. 4-5
	D x W x H					
TS108H26	1 x 106 x 26	70	30	2	\$1079	\$1349
TS102H26	1 x 100 x 26	85	24	2	\$1016	\$1270
TS96H26	1 x 94 x 26	92.5	20	2	\$960	\$1200
TS90H26	1 x 88 x 26	92.5	20	2	\$901	\$1126
TS84H26	1 x 82 x 26	100	18	2	\$837	\$1047
TS78H26	1 x 76 x 26	100	17	2	\$778	\$972
TS72H26	1 x 70 x 26	70	16	1	\$482	\$603
TS66H26	1 x 64 x 26	85	14	1	\$443	\$554
TS60H26	1 x 58 x 26	85	13	1	\$405	\$507
TS36H26	1 x 34 x 26	100	8	1	\$252	\$316
TS30H26	1 x 28 x 26	150	5	1	\$213	\$267

For use on **16.5"H** overhead storage (**CSFO_**, **CSF_**) at a finished height of **72"**. See Tackboard Notes above for exact fabric availability. List Price shown applies for all fabric grades.

- **NOTE:** Care should be taken to mount the units. Units should be mounted to wall studs using correct fasteners. Failure to do so may result in collapse of the unit and subsequent personal injury. **Mounting hardware not included.** Mounting hardware used should be based on wall material. Consult an installation professional for proper wall mounting.

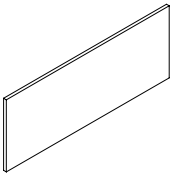

Tackboard - Wallmounted

TSP108H23	1 x 106 x 23	70	30	2	\$915	\$1171
TSP102H23	1 x 100 x 23	85	24	2	\$872	\$1111
TSP96H23	1 x 94 x 23	92.5	20	2	\$812	\$1042
TSP90H23	1 x 88 x 23	92.5	20	1	\$761	\$972
TSP84H23	1 x 82 x 23	70	18	1	\$714	\$908
TSP78H23	1 x 76 x 23	70	17	1	\$663	\$804
TSP72H23	1 x 70 x 23	70	16	1	\$616	\$603
TSP66H23	1 x 64 x 23	85	14	1	\$560	\$554
TSP60H23	1 x 58 x 23	85	13	1	\$405	\$507
TSP36H23	1 x 34 x 23	100	8	1	\$308	\$316
TSP30H23	1 x 28 x 23	150	5	1	\$253	\$267

For use on **19.5"H** overhead storage (**CSFOP_**, **CSFP_**) with Pigeon-Hole Storage at a finished height of **72"**. See Tackboard Notes above for exact fabric availability. List Price shown applies for all fabric grades.

- **NOTE:** Care should be taken to mount the units. Units should be mounted to wall studs using correct fasteners. Failure to do so may result in collapse of the unit and subsequent personal injury. **Mounting hardware not included.** Mounting hardware used should be based on wall material. Consult an installation professional for proper wall mounting.

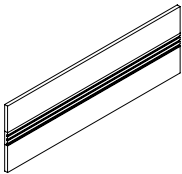

Tackboard - Accessory Rail, Wallmounted

TSAS108	1 x 106 x 20	92.5	23	2	\$1432	\$1790
TSAS102	1 x 100 x 20	100	19	2	\$1355	\$1694
TSAS96	1 x 94 x 20	70	15	1	\$1270	\$1588
TSAS90	1 x 88 x 20	70	15	1	\$1193	\$1492
TSAS84	1 x 82 x 20	85	14	1	\$1112	\$1390
TSAS78	1 x 76 x 20	85	13	1	\$1035	\$1294
TSAS72	1 x 70 x 20	85	12	1	\$953	\$1192
TSAS66	1 x 64 x 20	92.5	11	1	\$877	\$1097
TSAS60	1 x 58 x 20	92.5	10	1	\$795	\$994
TSAS36	1 x 34 x 20	125	6	1	\$475	\$594
TSAS30	1 x 28 x 20	150	4	1	\$368	\$460

For use on **16.5"H** overhead storage (**CSFO_**, **CSF_**) at a finished height of **66"**. See Tackboard Notes above for exact fabric availability. List Price shown applies for all fabric grades.

- **Must Specify Black (E) or Tungsten (K) Accessory Rail finish.**
- **NOTE:** Care should be taken to mount the units. Units should be mounted to wall studs using correct fasteners. Failure to do so may result in collapse of the unit and subsequent personal injury. **Mounting hardware not included.** Mounting hardware used should be based on wall material. Consult an installation professional for proper wall mounting.

Required Specifications

Fabric

WALLMOUNT TACKBOARDS

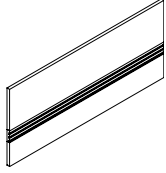

Tackboard - Accessory Rail, Wallmounted

MODEL#	DIMENSIONS D x W x H	FREIGHT CLASS	WT/LBS.	CUBIC FT.	GR. 1-3	GR. 4-5
TSAS108H26	1 x 106 x 26	70	23	2	\$1723	\$2154
TSAS102H26	1 x 100 x 26	85	19	2	\$1624	\$2030
TSAS96H26	1 x 94 x 26	92.5	15	1	\$1526	\$1908
TSAS90H26	1 x 88 x 26	92.5	15	1	\$1436	\$1795
TSAS78H26	1 x 76 x 26	100	13	1	\$1240	\$1550
TSAS72H26	1 x 70 x 26	70	12	1	\$1129	\$1412
TSAS66H26	1 x 64 x 26	85	11	1	\$1052	\$1315
TSAS60H26	1 x 58 x 26	85	10	1	\$953	\$1192
TSAS36H26	1 x 34 x 26	100	6	1	\$573	\$717
TSAS30H26	1 x 28 x 26	150	4	1	\$479	\$599

For use on **16.5"H** overhead storage (CSFO_, CSF_) at a finished height of **72"**. See Tackboard Notes above for exact fabric availability. List Price shown applies for all fabric grades.

• **Must Specify Black (E) or Tungsten (K) Accessory Rail finish.**

• **NOTE:** Care should be taken to mount the units. Units should be mounted to wall studs using correct fasteners. Failure to do so may result in collapse of the unit and subsequent personal injury. **Mounting hardware not included.** Mounting hardware used should be based on wall material. Consult an installation professional for proper wall mounting.

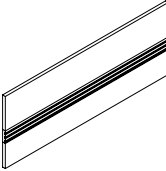

Tackboard - Accessory Rail, Wallmounted

TSPAS108H23	1 x 106 x 23	92.5	30	2	\$1552	\$1940
TSPAS102H23	1 x 100 x 23	100	24	2	\$1475	\$1844
TSPAS96H23	1 x 94 x 23	70	20	2	\$1385	\$1732
TSPAS90H23	1 x 88 x 23	70	20	2	\$1295	\$1619
TSPAS84H23	1 x 82 x 23	85	18	2	\$1210	\$1513
TSPAS78H23	1 x 76 x 23	85	17	2	\$1124	\$1405
TSPAS72H23	1 x 70 x 23	85	16	1	\$1039	\$1299
TSPAS66H23	1 x 64 x 23	92.5	14	1	\$953	\$1192
TSPAS60H23	1 x 58 x 23	92.5	13	1	\$864	\$1080
TSPAS36H23	1 x 34 x 23	125	8	1	\$432	\$540
TSPAS30H23	1 x 28 x 23	150	5	1	\$419	\$524

For use on **19.5"H** overhead storage (CSFOP_, CSFP_) with Pigeon-Hole Storage at a finished height of **72"**. See Tackboard Notes above for exact fabric availability. List Price shown applies for all fabric grades.

• **Must Specify Black (E) or Tungsten (K) Accessory Rail finish.**

• **NOTE:** Care should be taken to mount the units. Units should be mounted to wall studs using correct fasteners. Failure to do so may result in collapse of the unit and subsequent personal injury. **Mounting hardware not included.** Mounting hardware used should be based on wall material. Consult an installation professional for proper wall mounting.

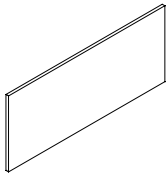

Tackboard - Wallmounted

TS108H25	1 x 106 x 25	92.5	23	2	\$1018	\$1273
TS102H25	1 x 100 x 25	100	19	2	\$958	\$1198
TS96H25	1 x 94 x 25	70	17	1	\$902	\$1128
TS90H25	1 x 88 x 25	70	15	1	\$847	\$1059
TS84H25	1 x 82 x 25	85	14	1	\$791	\$989
TS78H25	1 x 76 x 25	85	13	1	\$731	\$914
TS72H25	1 x 70 x 25	85	12	1	\$676	\$845
TS66H25	1 x 64 x 25	92.5	11	1	\$620	\$775
TS60H25	1 x 58 x 25	92.5	10	1	\$565	\$707

For use on **16.5"H** overhead storage (CSFO_, CSF_) mounted above 23"H credenzas for a finished height of **66"**. See Tackboard Notes above for exact fabric availability. List Price shown applies for all fabric grades

• **NOTE:** Care should be taken to mount the units. Units should be mounted to wall studs using correct fasteners. Failure to do so may result in collapse of the unit and subsequent personal injury. **Mounting hardware not included.** Mounting hardware used should be based on wall material. Consult an installation professional for proper wall mounting.

Required Specifications

Fabric

WALLMOUNT TACKBOARDS

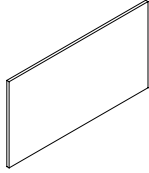

Tackboard - Wallmounted

MODEL#	DIMENSIONS D x W x H	FREIGHT CLASS	WT/LBS.	CUBIC FT.	GR. 1-3	GR. 4-5
TS108H32	1 x 106 x 32	70	30	2	\$1304	\$1630
TS102H32	1 x 100 x 32	85	24	2	\$1227	\$1534
TS96H32	1 x 94 x 32	92.5	20	2	\$1159	\$1449
TS90H32	1 x 88 x 32	92.5	20	2	\$1086	\$1358
TS84H32	1 x 82 x 32	100	18	2	\$1009	\$1262
TS78H32	1 x 76 x 32	100	17	2	\$936	\$1170
TS72H32	1 x 70 x 32	70	16	1	\$864	\$1080
TS66H32	1 x 64 x 32	85	14	1	\$795	\$994
TS60H32	1 x 58 x 32	85	13	1	\$723	\$904

For use on **16.5"H** overhead storage (**CSFO_**, **CSF_**) mounted above 23"H credenzas for a **finished height of 72"**. See *Tackboard Notes* above for exact fabric availability. List Price shown applies for all fabric grades

- **NOTE:** Care should be taken to mount the units. Units should be mounted to wall studs using correct fasteners. Failure to do so may result in collapse of the unit and subsequent personal injury. **Mounting hardware not included.** Mounting hardware used should be based on wall material. Consult an installation professional for proper wall mounting.

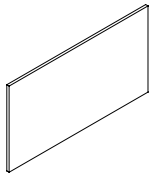

Tackboard - Wallmounted

TSP108H29	1 x 106 x 29	70	30	2	\$1180	\$1475
TSP102H29	1 x 100 x 29	85	24	2	\$1112	\$1390
TSP96H29	1 x 94 x 29	70	20	2	\$1048	\$1310
TSP90H29	1 x 88 x 29	70	20	2	\$983	\$1229
TSP84H29	1 x 82 x 29	70	18	2	\$915	\$1144
TSP78H29	1 x 76 x 29	70	17	2	\$851	\$1064
TSP72H29	1 x 70 x 29	70	16	1	\$783	\$979
TSP66H29	1 x 64 x 29	85	14	1	\$723	\$904
TSP60H29	1 x 58 x 29	85	13	1	\$654	\$818

For use on **16.5"H** overhead storage (**CSFO_**, **CSF_**) mounted above 23"H credenzas for a **finished height of 72"**. See *Tackboard Notes* above for exact fabric availability. List Price shown applies for all fabric grades

- **NOTE:** Care should be taken to mount the units. Units should be mounted to wall studs using correct fasteners. Failure to do so may result in collapse of the unit and subsequent personal injury. **Mounting hardware not included.** Mounting hardware used should be based on wall material. Consult an installation professional for proper wall mounting.

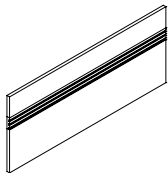

Tackboard - Accessory Rail, Wallmounted

TSAS108H25	1 x 106 x 25	92.5	23	2	\$1659	\$2074
TSAS102H25	1 x 100 x 25	100	19	2	\$1560	\$1950
TSAS96H25	1 x 94 x 25	70	15	1	\$1466	\$1833
TSAS90H25	1 x 88 x 25	70	15	1	\$1381	\$1727
TSAS78H25	1 x 76 x 25	85	13	1	\$1193	\$1492
TSAS72H25	1 x 70 x 25	85	12	1	\$1082	\$1353
TSAS66H25	1 x 64 x 25	92.5	11	1	\$1013	\$1267
TSAS60H25	1 x 58 x 25	92.5	10	1	\$919	\$1149

For use on **16.5"H** overhead storage (**CSFO_**, **CSF_**) mounted above 23"H credenzas for a **finished height of 66"**. See *Tackboard Notes* above for exact fabric availability. List Price shown applies for all fabric grades

- **Must Specify Black (E) or Tungsten (K) Accessory Rail finish.**
- **NOTE:** Care should be taken to mount the units. Units should be mounted to wall studs using correct fasteners. Failure to do so may result in collapse of the unit and subsequent personal injury. **Mounting hardware not included.** Mounting hardware used should be based on wall material. Consult an installation professional for proper wall mounting.

Required Specifications

Fabric

WALLMOUNT TACKBOARDS

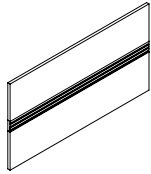

Tackboard - Accessory Rail, Wallmounted

MODEL#	DIMENSIONS D x W x H	FREIGHT CLASS	WT/LBS.	CUBIC FT.	GR. 1-3	GR. 4-5
TSAS108H32	1 x 106 x 32	70	23	2	\$2120	\$2650
TSAS102H32	1 x 100 x 32	85	19	2	\$1996	\$2495
TSAS96H32	1 x 94 x 32	92.5	15	1	\$1881	\$2352
TSAS90H32	1 x 88 x 32	92.5	15	1	\$1770	\$2213
TSAS78H32	1 x 76 x 32	100	13	1	\$1526	\$1908
TSAS72H32	1 x 70 x 32	70	12	1	\$1385	\$1732
TSAS66H32	1 x 64 x 32	85	11	1	\$1295	\$1619
TSAS60H32	1 x 58 x 32	85	10	1	\$1176	\$1470

For use on **16.5"H** overhead storage (CSFO_, CSF_) mounted above 23"H credenzas for a **finished height of 72"**. See Tackboard Notes above for exact fabric availability. List Price shown applies for all fabric grades

• **Must Specify Black (E) or Tungsten (K) Accessory Rail finish.**

• **NOTE:** Care should be taken to mount the units. Units should be mounted to wall studs using correct fasteners. Failure to do so may result in collapse of the unit and subsequent personal injury. **Mounting hardware not included.** Mounting hardware used should be based on wall material. Consult an installation professional for proper wall mounting.

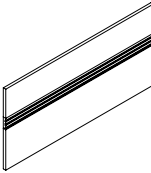

Tackboard - Accessory Rail, Wallmounted

TSPAS108H29	1 x 106 x 29	70	30	2	\$1924	\$2405
TSPAS102H29	1 x 100 x 29	85	24	2	\$1808	\$2260
TSPAS96H29	1 x 94 x 29	70	20	2	\$1701	\$2127
TSPAS90H29	1 x 88 x 29	70	20	2	\$1603	\$2004
TSPAS78H29	1 x 76 x 29	70	17	2	\$1385	\$1732
TSPAS72H29	1 x 70 x 29	70	16	1	\$1257	\$1572
TSPAS66H29	1 x 64 x 29	85	14	1	\$1176	\$1470
TSPAS60H29	1 x 58 x 29	85	13	1	\$1065	\$1332

For use on **16.5"H** overhead storage (CSFO_, CSF_) mounted above 23"H credenzas for a **finished height of 72"**. See Tackboard Notes above for exact fabric availability. List Price shown applies for all fabric grades

• **Must Specify Black (E) or Tungsten (K) Accessory Rail finish.**

• **NOTE:** Care should be taken to mount the units. Units should be mounted to wall studs using correct fasteners. Failure to do so may result in collapse of the unit and subsequent personal injury. **Mounting hardware not included.** Mounting hardware used should be based on wall material. Consult an installation professional for proper wall mounting.

PIGEON-HOLE STORAGE

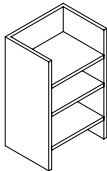

Vertical Pigeon-Hole Storage

CPH161226	12 x 16 x 26	125	20	3	\$560
CPH161223	12 x 16 x 23	125	18	3	\$475
CPH161219	12 x 16 x 19	125	15	2	\$359
CPH131226	12 x 13 x 26	100	16	2	\$453
CPH131223	12 x 13 x 23	125	15	2	\$385
CPH131219	12 x 13 x 19	125	12	2	\$291

Used in conjunction with overhead storage units and hutches that incorporate horizontal pigeon-hole storage. Not freestanding. Shipped RTA (ready to assemble).

ACCESSORY RAIL/ PANEL ORGANIZERS

Available Finishes:

BLK	Black	SIL	Silver
CHR	Charcoal	TPE	Taupe
DWT	Designer White	TUN	(Tungsten)
NEV	Nevada		

Required Specifications

Fabric
Veneer Finish (Pigeon-Hole Storage)

ACCESSORY RAIL/ PANEL ORGANIZERS

MODEL# DIMENSIONS FREIGHT CLASS WT/LBS. CUBIC FT. LIST PRICE

D x W x H

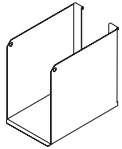

Binder Bin

BABB01 10.25 x 4 x 9 100 2 .21 **\$51**

Load bar/accessory rail mounted metal binder bin.

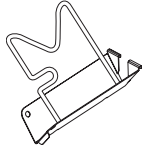

Flip Sorter

BAFS01 9.25 x 2.75 x 9.25 70 .06 .14 **\$38**

Load bar/accessory rail mounted metal flip sorter. Comes with chrome wire.

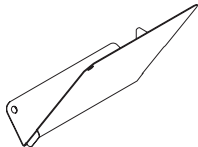

Slant Sorter

BASS01L 10.25 x 5 x 9.5 70 1 .28 **\$32**

(Left)

BASS01R 10.25 x 5 x 9.5 70 1 .28 **\$32**

(Right)

Load bar/accessory rail mounted metal slant sorter.

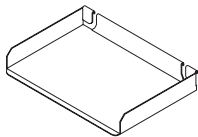

Letter Tray

BALT01 9.25 x 13.5 x 2 70 .50 .15 **\$41**

Load bar/accessory rail mounted metal letter tray.

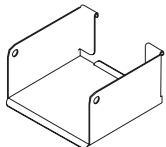

Media Bin

BAMB01 5.25 x 5.75 x 3 70 .08 .05 **\$41**

Load bar/accessory rail mounted metal media bin.

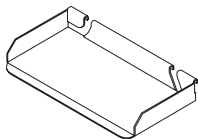

Utility Tray

BAUT01 3.75 x 5.75 x 3 70 .05 .02 **\$27**

Load bar/accessory rail mounted metal utility tray.

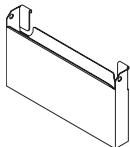

Mail Box

BAPP01 2.75 x 16 x 9 100 2 .25 **\$66**

Load bar/accessory rail mounted metal mail box.

Required Specifications

Metal Finish

ACCESSORY RAIL/PANEL ORGANIZERS

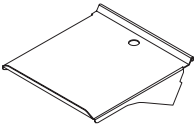

Telephone Holder

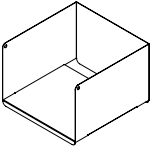

Elevated Shelf Binder Bin

MODEL#	DIMENSIONS D x W x H	FREIGHT CLASS	WT/LBS.	CUBIC FT.	LIST PRICE
BATH01	10 x 9 x 2	125	2	.26	\$63
Load bar/accessory rail mounted metal telephone holder.					
BRTESBBIN	12 x 12 x 8	100	6	.66	\$137

Load bar/accessory rail mounted elevated shelf binder bin.

RECEPTION DESKS

- To add storage use storage shells. See pages 109-110.
- Includes GM1 grommet.
- Transaction tops to be specified separately, handed by square edge from user side.
- Decorative Front Panels should be specified separately. Size chosen should be 12" less than desk dimensions. Available in Reverse Diamond, Vertical Rib, Vertical Grain and Horizontal Grain Patterns.

OPTION DETAILS

Decorative Front Panel (Reverse Diamond Pattern)
GFDP5430F

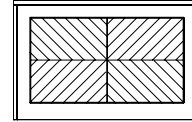

Decorative Front Panel (Vertical Rib Pattern)
GFDP5430RIB

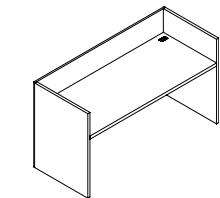
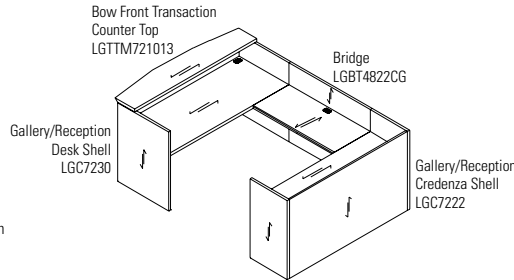
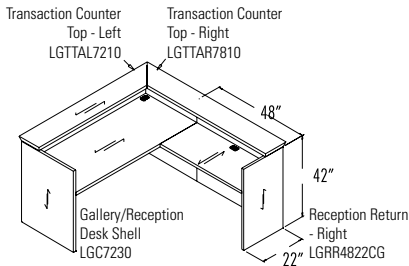
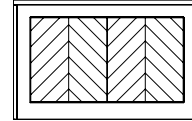

Gallery/Reception Desk Shell

LGC10836	36 x 108 x 42	150	533	95	\$5039
LGC10236	36 x 102 x 42	150	503	89	\$4760
LGC9636	36 x 96 x 42	150	473	84	\$4480
LGC9036	36 x 90 x 42	150	444	79	\$4200
LGC8436	36 x 84 x 42	150	414	74	\$3921
LGC7236	36 x 72 x 42	150	355	63	\$3361
LGC7230	30 x 72 x 42	150	315	53	\$3252
LGC6630	30 x 66 x 42	125	295	48	\$2929
LGC6030	30 x 60 x 42	125	275	44	\$3172

No pedestals. Two grommets in worksurface. For use with modular storage components.

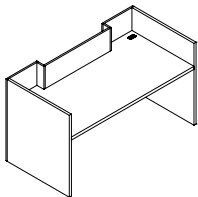

**Gallery/Reception Desk Shell
Breakfront Style**

LGIC10836	36 x 108 x 42	150	533	95	\$6198
LGIC10236	36 x 102 x 42	150	503	89	\$5849
LGIC9636	36 x 96 x 42	150	473	84	\$5511
LGIC9036	36 x 90 x 42	150	444	79	\$5163
LGIC8436	36 x 84 x 42	150	414	74	\$4825
LGIC7236	36 x 72 x 42	150	355	63	\$4127
LGIC7230	30 x 72 x 42	150	315	53	\$3996
LGIC6630	30 x 66 x 42	125	295	48	\$3895
LGIC6030	30 x 60 x 42	125	275	44	\$3670

No pedestals. Two grommets in worksurface. For use with modular storage components.

Required Specifications

Metal Finish (Accessories)
Veneer Finish
Edge

RECEPTION DESKS

MODEL# DIMENSIONS FREIGHT CLASS WT/LBS. CUBIC FT. LIST PRICE

D x W x H

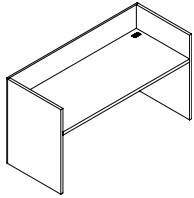

Gallery/Reception Credenza Shell

LGC10824	24 x 108 x 42	150	353	63	\$3950
LGC10224	24 x 102 x 42	150	333	60	\$3735
LGC9624	24 x 96 x 42	150	314	56	\$3510
LGC9024	24 x 90 x 42	150	294	53	\$3288
LGC8424	24 x 84 x 42	150	274	49	\$3074
LGC7224	24 x 72 x 42	150	235	42	\$2638
LGC6624	24 x 66 x 42	150	216	39	\$2475
LGC6024	24 x 60 x 42	150	196	35	\$2318

No pedestals. Two grommets in worksurface. For use with modular storage components.

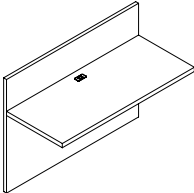

Bridge

LGBT5624CG	24 x 56 x 42	150	178	32	\$2213
LGBT5424CG	24 x 54 x 42	150	169	29	\$2213
LGBT5024CG	24 x 50 x 42	150	151	27	\$1962
LGBT4824CG	24 x 48 x 42	150	142	26	\$1962
LGBT4424CG	24 x 44 x 42	150	134	23	\$1723
LGBT4224CG	24 x 42 x 42	150	127	22	\$1723
LGBT3824CG	24 x 38 x 42	150	119	20	\$1548
LGBT3624CG	24 x 36 x 42	150	112	19	\$1548

Attaches between **Gallery Desk and Gallery Credenza Only**. One grommet in center of worksurface. Shipped RTA (ready to assemble).

- To remove cross-grain veneer pattern on top, **delete "CG"** from model number. Available as a special - no upcharge.

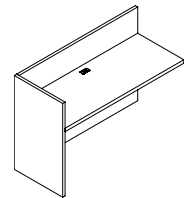

Reception Return - LEFT

LGRL7224	24 x 72 x 42	125	273	42	\$3314
LGRL6624	24 x 66 x 42	125	250	39	\$3045
LGRL6024	24 x 60 x 42	125	228	35	\$2769
LGRL5424	24 x 54 x 42	125	205	32	\$2489
LGRL4824	24 x 48 x 42	125	182	28	\$2213
LGRL4224	24 x 42 x 42	125	159	25	\$1937
LGRL3624	24 x 36 x 42	125	137	21	\$1737

No pedestal. One grommet in center of worksurface. For use with modular storage components.

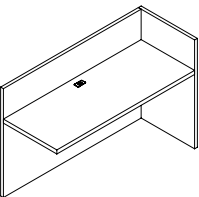

Reception Return - RIGHT

LGRR7224	24 x 72 x 42	125	273	42	\$3314
LGRR6624	24 x 66 x 42	125	250	39	\$3045
LGRR6024	24 x 60 x 42	125	228	35	\$2769
LGRR5424	24 x 54 x 42	125	205	32	\$2489
LGRR4824	24 x 48 x 42	125	182	28	\$2213
LGRR4224	24 x 42 x 42	125	159	25	\$1937
LGRR3624	24 x 36 x 42	125	137	21	\$1737

No pedestal. One grommet in center of worksurface. For use with modular storage components.

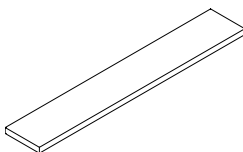

Transaction Counter Top

LGTT10810	10 x 108 x 1.50	100	78	8	\$935
LGTT10210	10 x 102 x 1.50	92.5	72	7	\$884
LGTT9610	10 x 96 x 1.50	100	66	7	\$833
LGTT9010	10 x 90 x 1.50	92.5	60	6	\$782
LGTT8410	10 x 84 x 1.50	100	54	6	\$731
LGTT7210	10 x 72 x 1.50	100	48	5	\$618
LGTT6610	10 x 66 x 1.50	100	42	5	\$567
LGTT6010	10 x 60 x 1.50	100	36	4	\$516

Rectangular top for main reception desk. Counter sits on top of Gallery panels. Does not overhang. **Factory installed - specify Gallery to be used on.** Size must match dimension of desk front or combined desk side and return length. Hardware included.

Required Specifications

- Veneer Finish
- Edge

RECEPTION DESKS

MODEL#	DIMENSIONS	FREIGHT CLASS	WT/LBS.	CUBIC FT.	LIST PRICE
D x W x H					
LGTTM1081013	10-13 x 108 x 1.50	125	78	10	\$1468
LGTTM1021013	10-13 x 102 x 1.50	100	72	9	\$1389
LGTTM961013	10-13 x 96 x 1.50	125	66	9	\$1305
LGTTM901013	10-13 x 90 x 1.50	125	60	8	\$1221
LGTTM841013	10-13 x 84 x 1.50	125	54	8	\$1141
LGTTM721013	10-13 x 72 x 1.50	125	48	7	\$981
LGTTM661013	10-13 x 66 x 1.50	125	42	6	\$898
LGTTM601013	10-13 x 60 x 1.50	125	36	5	\$815

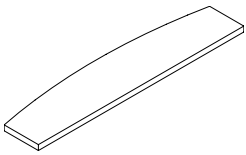

Bow Front Transaction Counter Top

Bow top for main reception desk. Counter sits on top of Gallery panels. Bow front overhangs 3". **Factory installed - specify Gallery to be used on.** Size must match dimension of desk front or combined desk side and return length. Hardware included.

GTT10810G	10 x 108 x 1.50	100	78	8	\$2137
GTT10210G	10 x 102 x 1.50	92.5	72	7	\$2057
GTT9610G	10 x 96 x 1.50	100	66	7	\$1977
GTT9010G	10 x 90 x 1.50	92.5	60	6	\$1897
GTT8410G	10 x 84 x 1.50	100	54	6	\$1817
GTT7210G	10 x 72 x 1.50	100	48	5	\$1700
GTT6610G	10 x 66 x 1.50	100	42	5	\$1621
GTT6010G	10 x 60 x 1.50	100	36	4	\$1541

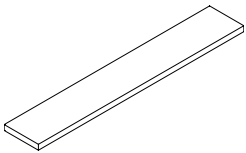

Transaction Counter Top

Rectangular top for main reception desk. Counter sits on top of Gallery panels. Does not overhang. **Factory installed - specify Gallery to be used on.** Size must match dimension of desk front or combined desk side and return length. Hardware included.

GTTM1081013G	10-13 x 108 x 1.50	125	78	10	\$2638
GTTM1021013G	10-13 x 102 x 1.50	100	72	9	\$2587
GTTM961013G	10-13 x 96 x 1.50	125	66	9	\$2562
GTTM901013G	10-13 x 90 x 1.50	125	60	8	\$2449
GTTM841013G	10-13 x 84 x 1.50	125	54	8	\$2329
GTTM721013G	10-13 x 72 x 1.50	125	48	7	\$2141
GTTM661013G	10-13 x 66 x 1.50	125	42	6	\$2021
GTTM601013G	10-13 x 60 x 1.50	125	36	5	\$1908

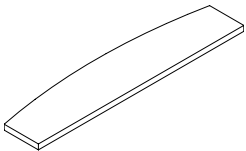

Bow Front Transaction Counter Top

Bow top for main reception desk. Counter sits on top of Gallery panels. Bow front overhangs 3". **Factory installed - specify Gallery to be used on.** Size must match dimension of desk front or combined desk side and return length. Hardware included.

GFDP9630F	1 x 96 x 30	92.5	81	8	\$1207
GFDP9030F	1 x 90 x 30	100	78	8	\$1131
GFDP8430F	1 x 84 x 30	92.5	72	7	\$1054
GFDP7230F	1 x 72 x 30	100	66	7	\$906
GFDP6030F	1 x 60 x 30	92.5	60	6	\$756
GFDP5430F	1 x 54 x 30	100	54	6	\$680
GFDP4830F	1 x 48 x 30	100	48	5	\$604

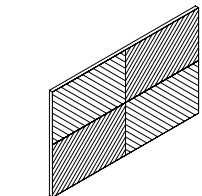

**Decorative Front Panel
Reverse Diamond Pattern**

Raised decorative front panel for a reception desk. Size should be 12" less than desk dimensions. **Factory installed.** Hardware included.

GFDP9630V	1 x 96 x 30	92.5	81	8	\$1051
GFDP9030V	1 x 90 x 30	100	78	8	\$986
GFDP8430V	1 x 84 x 30	92.5	72	7	\$920
GFDP7230V	1 x 72 x 30	100	66	7	\$786
GFDP6030V	1 x 60 x 30	92.5	60	6	\$655
GFDP5430V	1 x 54 x 30	100	54	6	\$593
GFDP4830V	1 x 48 x 30	100	48	5	\$524

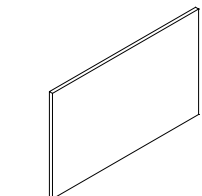

**Decorative Front Panel
Vertical Grain Pattern**

Raised decorative front panel for a reception desk. Size should be 12" less than desk dimensions. **Factory installed.** Hardware included.

Required Specifications

Veneer Finish
Edge

boardroom tables



global

T BOARDROOM TABLE NOTES

Grommets

- Optional grommets may be ordered in standard table top locations (left, center or right). Order as **GM1TL, GM1TC or GM1TR**. **ADD 69.00.**
- Grommet hole dimensions are 2 ¾" in diameter. Specify **GM1** for **Black** or **GM1K** for **Tungsten**. **Standard Grommet Locations:**

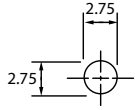

Grommet Locations - Boardroom Tables

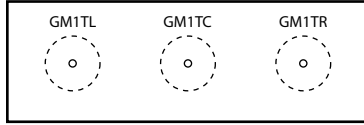

Top Left Top Center Top Right



Top Center

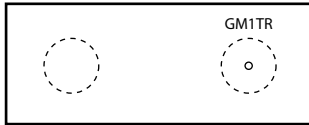

Top Right

Power/Data Accessories

- Power/data accessories may be factory installed on Boardroom Table tops.
- Please specify location in top as left, center or right (**TL, TC, or TR**) as per line drawing below. Location must be specified on product to be placed on at the time of the order. Please note location of power/data accessories on Boardroom Table tops is vertically centered, as per drawing below.

Power/Data Locations - Boardroom Tables

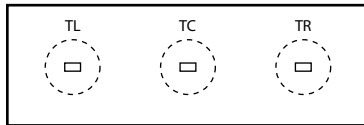

Top Left Top Center Top Right

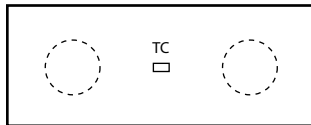

Top Center

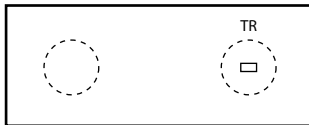

Top Right

Oasis Mini Cutouts

- Optional Oasis Mini cutout available in standard worksurface locations (left, center or right) **for Dufferin and Lufton Boardroom Tables**. Order as: **TL/M, TC/M or TR/M** - **Add \$200 for each cutout.**
- Oasis Mini cutouts may be placed at non-standard locations. Please contact customer care.

Oasis Mini A & B Locations - Boardroom Tables

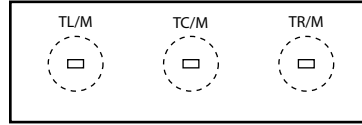

Top Left Top Center Top Right

OASIS MINI A & B CABLE LENGTHS NEEDED FOR DAISY-CHAINING

Model #	Oasis Mini A & Oasis Mini B	Oasis Mini A & Oasis Mini B	Oasis Mini A	Oasis Mini A	Oasis Mini B	Oasis Mini B
Cutout Positions	TL/M & TR/M	TL/M & TR/M	TL/M, TC/M & TR/M	TL/M, TC/M & TR/M	TL/M, TC/M & TR/M	TL/M, TC/M & TR/M
Infeed Position	Left or Right	Center	Left or Right	Center	Left or Right	Center
Reference	Drawing 1A/1B	Drawing 2A/2B	Drawing 3	Drawing 4	Drawing 5	Drawing 6
8' Dufferin & Lufton Tables	(1) 42FF-55 SPECIFY INFEED	(1) 42FF-29 (1) 42FM-29 (1) DAISY-T SPECIFY INFEED	N/A	N/A	N/A	N/A
10' Dufferin & Lufton Tables	(1) 42FF-79 SPECIFY INFEED	(1) 42FF-41 (1) 42FM-41 (1) DAISY-T SPECIFY INFEED	(3) 42FF-37 SPECIFY INFEED	(3) 42FF-37 SPECIFY INFEED	(2) 42FF-37 SPECIFY INFEED	(2) 42FF-37 (1) 42FM-12 (1) DAISY-T SPECIFY INFEED
12' Dufferin & Lufton Tables	(1) 42FF-103 SPECIFY INFEED	(1) 42FF-55 (1) 42FM-55 (1) DAISY-T SPECIFY INFEED	(3) 42FF-52 SPECIFY INFEED	(3) 42FF-52 SPECIFY INFEED	(2) 42FF-52 SPECIFY INFEED	(2) 42FF-52 (1) 42FM-12 (1) DAISY-T SPECIFY INFEED
14' Dufferin & Lufton Tables	(1) 42FF-64 (1) 42FM-64 SPECIFY INFEED	1) 42FF-67 (1) 42FM-67 (1) DAISY-T SPECIFY INFEED	(3) 42FF-61 SPECIFY INFEED	(3) 42FF-61 SPECIFY INFEED	(2) 42FF-61 SPECIFY INFEED	(2) 42FF-61 (1) 42FM-12 (1) DAISY-T SPECIFY INFEED
16' Dufferin & Lufton Tables	(1) 42FF-79 (1) 42FM-79 SPECIFY INFEED	1) 42FF-82 (1) 42FM-82 (1) DAISY-T SPECIFY INFEED	(3) 42FF-76 SPECIFY INFEED	(3) 42FF-76 SPECIFY INFEED	(2) 42FF-76 SPECIFY INFEED	(2) 42FF-76 (1) 42FM-12 (1) DAISY-T SPECIFY INFEED
18' Dufferin & Lufton Tables	(1) 42FF-88 (1) 42FM-88 SPECIFY INFEED	1) 42FF-91 (1) 42FM-91 (1) DAISY-T SPECIFY INFEED	(3) 42FF-85 SPECIFY INFEED	(3) 42FF-85 SPECIFY INFEED	(2) 42FF-85 SPECIFY INFEED	(2) 42FF-85 (1) 42FM-12 (1) DAISY-T SPECIFY INFEED
20' Dufferin & Lufton Tables	(1) 42FF-100 (1) 42FM-100 SPECIFY INFEED	1) 42FF-103 (1) 42FM-103 (1) DAISY-T SPECIFY INFEED	(3) 42FF-100 SPECIFY INFEED	(3) 42FF-100 SPECIFY INFEED	(2) 42FF-100 SPECIFY INFEED	(2) 42FF-100 (1) 42FM-12 (1) DAISY-T SPECIFY INFEED

Interconnecting Cables - Common Cable Lengths (in inches)

Female/Female

42FF-21	\$80	42FF-94	\$148	42FM-91	\$150
42FF-29	\$88	42FF-100	\$153	42FM-94	\$151
42FF-32	\$90	42FF-103	\$156	42FM-103	\$161
42FF-37	\$95	42FF-106	\$158	42FM-106	\$163
42FF-41	\$99	42FF-112	\$164	42FM-115	\$172
42FF-46	\$103	42FF-115	\$167	42FM-118	\$175
42FF-52	\$109	42FF-118	\$170		
42FF-55	\$112				
42FF-58	\$114				
42FF-61	\$117	Female/Male			
42FF-64	\$120	42FM-12	\$76		
42FF-67	\$123	42FM-21	\$85		
42FF-70	\$125	42FM-32	\$95		
42FF-76	\$131	42FM-46	\$108		
42FF-79	\$134	42FM-55	\$116		
42FF-82	\$137	42FM-58	\$119		
42FF-85	\$139	42FM-67	\$127		
42FF-88	\$142	42FM-70	\$130		
42FF-91	\$145	42FM-79	\$138		
		42FM-82	\$141		

T BOARDROOM TABLE NOTES

DRAWING 1A - MINI OASIS A

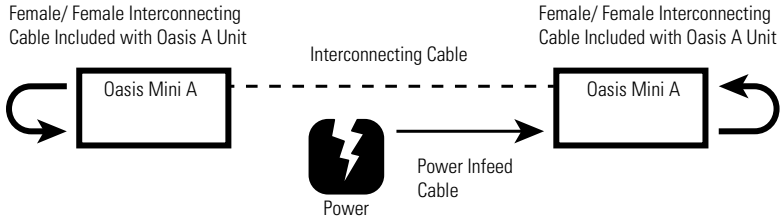

DRAWING 1B - MINI OASIS B

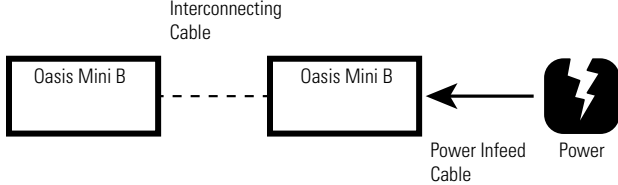

DRAWING 2A - MINI OASIS A

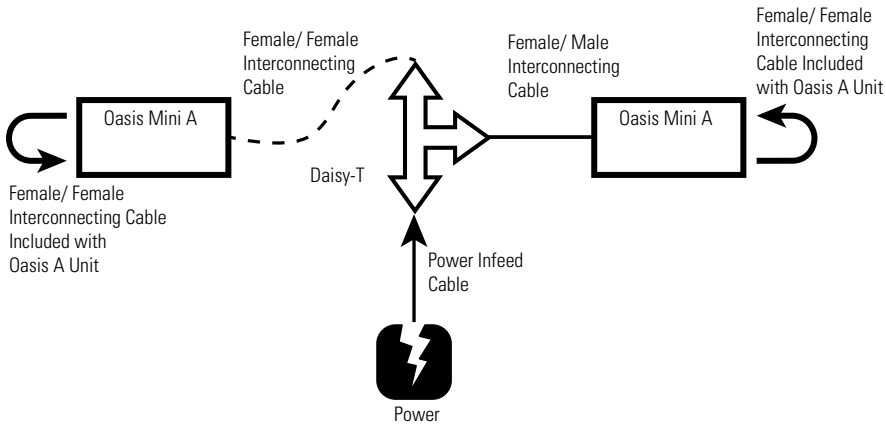

DRAWING 2B - MINI OASIS B

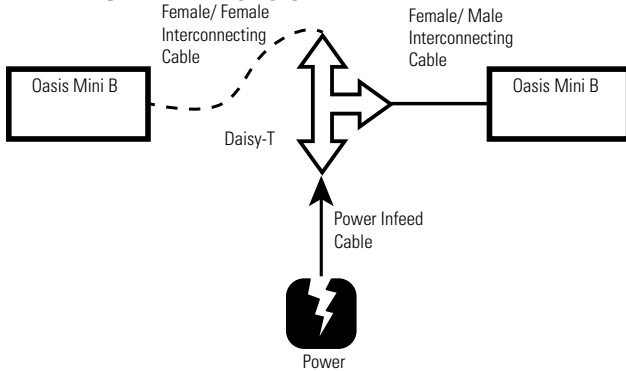

DRAWING 3 - MINI OASIS A

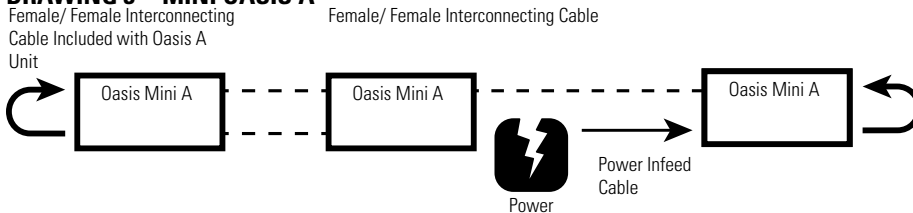

DRAWING 4 - MINI OASIS A

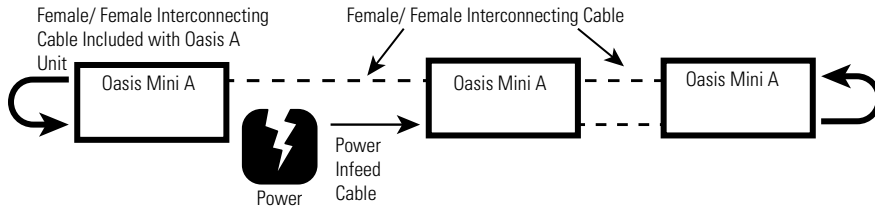

DRAWING 5 - MINI OASIS B

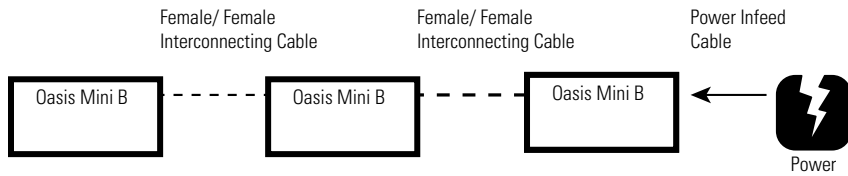

DRAWING 6 - MINI OASIS B

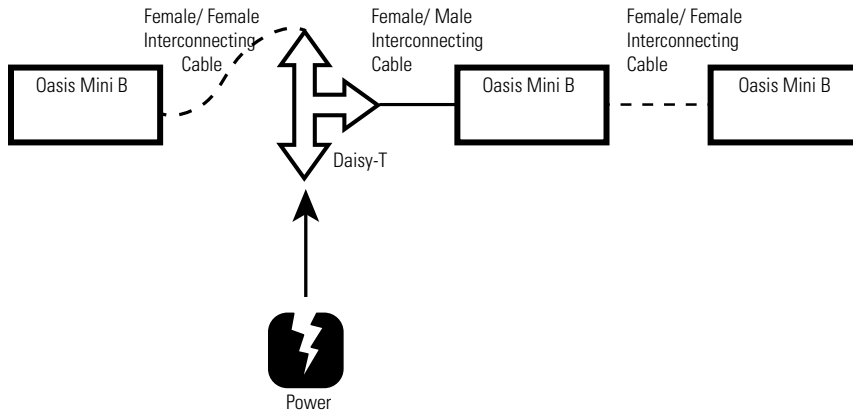

T BOARDROOM TABLES

BOARDROOM TABLE TOP AND BASE GUIDE

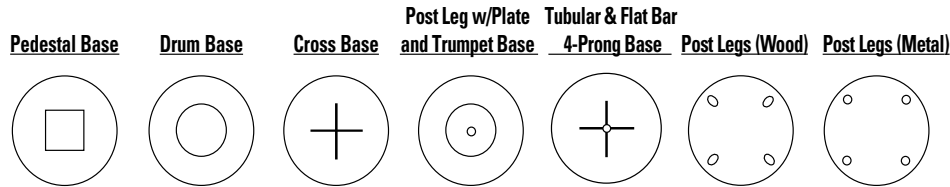

Requires 1 of the following: Pedestal, Drum, Cross, Post Leg w/Plate, Tubular and Flat Bar 4-Prong base, Trumpet Column Base

Requires 4 of the following: Wood Post Legs or Metal Post Legs.

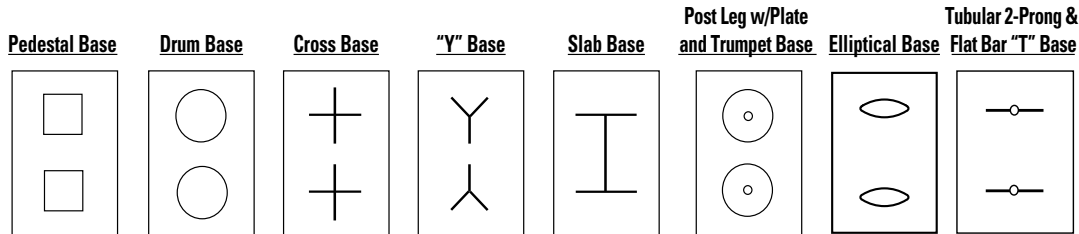

3-Prong Tubular or

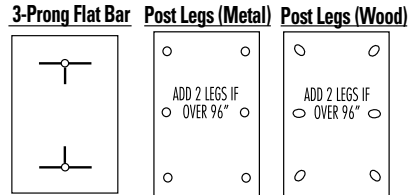
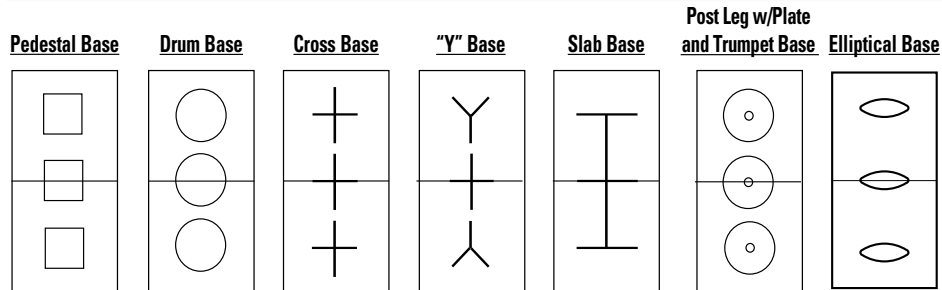

Table Tops up to 120" are in one section and require (2) bases.

Tubular, 2-Prong Base - Table Tops up to 84" require (2) bases.

Tubular and Flat Bar "T" Base - Table Tops up to 120" require (2) bases.

Post Legs - Table Tops up to 96" are in one section and require (4) legs. Tops 108" to 168" require (6) legs.



3-Prong Tubular or

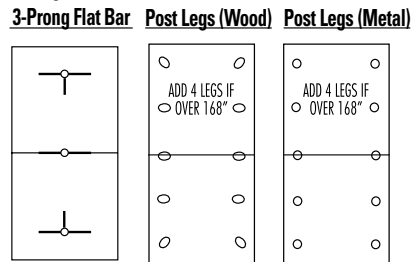

Table Tops 144" and over are in two sections and require (3) bases.

"Y" Base - Require (2) "Y" bases and (1) Cross base in the center.

Slab Base - Require (3) Slab bases.

Tubular and Flat Bar 3-Prong Base - Require (2) 3-Prong bases and (1) 2-Prong base in the center.

Post Legs - Table Tops 180" to 240" require (10) legs.

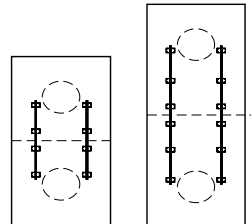

If design considerations or dimension requirements dictate an unsupported table joint, use metal table support rail.

Top section must not exceed 72" to use metal supports.

BOARDROOM TABLES - TOPS WITH DUFFERIN EDGE

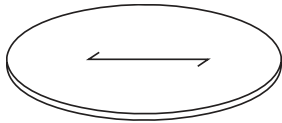

Round Top

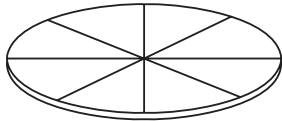

Round Top - Sunburst Veneer Pattern

MODEL#	DIMENSIONS D x W x H	FREIGHT CLASS	WT/LBS.	CUBIC FT.	LIST PRICE
RO60D	60 x 60 x 1.50	85	150	11	\$1988
RO48D	48 x 48 x 1.50	85	96	7	\$1590
RO42D	42 x 42 x 1.50	85	74	6	\$1438
RO36D	36 x 36 x 1.50	85	54	4	\$1221
RO30D	30 x 30 x 1.50	85	38	3	\$853

For use with Drum Base, Pedestal Base, Cross Base, Wood Post Legs, Metal Post Legs and 4 Prong Base.

RO60SD	60 x 60 x 1.50	85	150	11	\$2153
RO48SD	48 x 48 x 1.50	85	96	7	\$1822
RO42SD	42 x 42 x 1.50	85	74	6	\$1557
RO36SD	36 x 36 x 1.50	85	54	4	\$1340
RO30SD	30 x 30 x 1.50	85	38	3	\$1113

For use with Drum Base, Pedestal Base, "X" Shape Slab Base, Wood Post Legs, Metal Post Legs and 4 Prong Base.

RE24054D	54 x 240 x 1.50	85	540	39	\$6375
RE21654D	54 x 216 x 1.50	85	486	35	\$5737
RE19254D	54 x 192 x 1.50	85	432	31	\$4923
RE5454D	54 x 54 x 1.50	85	121	9	\$1399
RE16848D	48 x 168 x 1.50	85	336	25	\$3664
RE14448D	48 x 144 x 1.50	85	288	21	\$2761
RE12048D	48 x 120 x 1.50	85	240	18	\$2457
RE9648D	48 x 96 x 1.50	85	192	14	\$1814
RE4848D	48 x 48 x 1.50	85	96	7	\$996
RE8442D	42 x 84 x 1.50	85	147	11	\$1669
RE7242D	42 x 72 x 1.50	85	126	9	\$1428
RE4242D	42 x 42 x 1.50	85	74	5	\$931
RE8436D	36 x 84 x 1.50	85	126	9	\$1593
RE7236D	36 x 72 x 1.50	85	108	8	\$1366
RE6636D	36 x 66 x 1.50	85	99	7	\$1047
RE3636D	36 x 36 x 1.50	85	54	4	\$570
RE8430D	30 x 84 x 1.50	85	105	8	\$1329
RE7230D	30 x 72 x 1.50	85	90	7	\$1139
RE6630D	30 x 66 x 1.50	85	83	6	\$1047
RE6030D	30 x 60 x 1.50	85	75	6	\$950
RE5430D	30 x 54 x 1.50	85	68	5	\$857
RE3030D	30 x 30 x 1.50	85	38	3	\$477
RE8424D	24 x 84 x 1.50	85	84	6	\$1160
RE7224D	24 x 72 x 1.50	85	72	5	\$994
RE6624D	24 x 66 x 1.50	85	66	5	\$913
RE6024D	24 x 60 x 1.50	70	60	4	\$829
RE5424D	24 x 54 x 1.50	85	55	4	\$746
RE4824D	24 x 48 x 1.50	70	48	3	\$718
RE2424D	24 x 24 x 1.50	125	21	3	\$329
RE8422D	22 x 84 x 1.50	85	77	6	\$1065
RE7222D	22 x 72 x 1.50	85	66	5	\$913
RE6622D	22 x 66 x 1.50	85	61	5	\$834
RE6022D	22 x 60 x 1.50	85	55	4	\$760
RE5422D	22 x 54 x 1.50	85	50	4	\$686
RE4822D	22 x 48 x 1.50	85	44	3	\$658
RE2222D	22 x 22 x 1.50	92.5	20	2	\$301

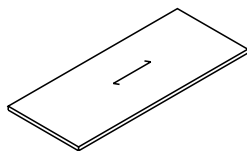

Rectangular Top

Grain runs the **length** of the worksurface. Tops 120" and under are shipped in one piece and require 2 bases. Tops 144" and over are shipped in two pieces and require 3 bases.

Required Specifications

Veneer Finish

Optional Specifications

Boardroom Table Base
Grommet (not available on Round Tops)

T BOARDROOM TABLES - DUFFERIN

BOARDROOM TABLES - TOPS

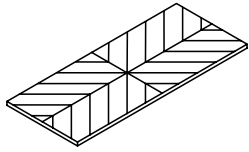

**Rectangular Top -
Reverse Diamond Pattern**

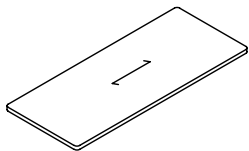

Rectangular Top Radius Corners

MODEL#	DIMENSIONS D x W x H	FREIGHT CLASS	WT/LBS.	CUBIC FT.	LIST PRICE
RE24054FD	54 x 240 x 1.50	85	540	39	\$7306
RE21654FD	54 x 216 x 1.50	85	486	35	\$6605
RE19254FD	54 x 192 x 1.50	85	432	31	\$5709
RE5454FD	54 x 54 x 1.50	85	119	9	\$1598
RE16848FD	48 x 168 x 1.50	85	336	25	\$4325
RE14448FD	48 x 144 x 1.50	85	288	21	\$3332
RE12048FD	48 x 120 x 1.50	85	240	18	\$2899
RE9648FD	48 x 96 x 1.50	85	192	14	\$2192
RE4848FD	48 x 48 x 1.50	85	98	7	\$1167
RE8442FD	42 x 84 x 1.50	85	147	11	\$2005
RE7242FD	42 x 72 x 1.50	85	126	9	\$1742
RE4242FD	42 x 42 x 1.50	85	74	5	\$1098
RE8436FD	36 x 84 x 1.50	85	126	9	\$1875
RE7236FD	36 x 72 x 1.50	85	108	8	\$1612
RE6636FD	36 x 66 x 1.50	85	99	7	\$1227
RE3636FD	36 x 36 x 1.50	85	54	4	\$783
RE8430FD	30 x 84 x 1.50	85	105	8	\$1561
RE7230FD	30 x 72 x 1.50	85	90	7	\$1394
RE6630FD	30 x 66 x 1.50	85	83	6	\$1343
RE6030FD	30 x 60 x 1.50	85	75	6	\$1227
RE5430FD	30 x 54 x 1.50	85	68	5	\$1005
RE3030FD	30 x 30 x 1.50	85	38	3	\$556

Tops 120" and under are shipped in one piece and require 2 bases. Tops 144" and over are shipped in two pieces and require 3 bases.

RRE24054D	54 x 240 x 1.50	85	540	39	\$7772
RRE21654D	54 x 216 x 1.50	85	486	35	\$7037
RRE19254D	54 x 192 x 1.50	85	432	31	\$6102
RRE5454D	54 x 54 x 1.50	85	119	9	\$1700
RRE16848D	48 x 168 x 1.50	85	336	25	\$4655
RRE14448D	48 x 144 x 1.50	85	288	21	\$3616
RRE12048D	48 x 120 x 1.50	85	240	18	\$3119
RRE9648D	48 x 96 x 1.50	85	192	14	\$2380
RRE4848D	48 x 48 x 1.50	85	98	7	\$1250
RRE8442D	42 x 84 x 1.50	85	147	11	\$2174
RRE7242D	42 x 72 x 1.50	85	126	9	\$1897
RRE4242D	42 x 42 x 1.50	85	74	5	\$1176
RRE8436D	36 x 84 x 1.50	85	126	9	\$2019
RRE7236D	36 x 72 x 1.50	85	108	8	\$1732
RRE6636D	36 x 66 x 1.50	85	99	7	\$1320
RRE3636D	36 x 36 x 1.50	85	54	4	\$723
RRE8430D	30 x 84 x 1.50	85	105	8	\$1681
RRE7230D	30 x 72 x 1.50	85	90	7	\$1440
RRE6630D	30 x 66 x 1.50	85	83	6	\$1320
RRE6030D	30 x 60 x 1.50	85	75	6	\$1204
RRE5430D	30 x 54 x 1.50	85	68	5	\$1079
RRE3030D	30 x 30 x 1.50	85	38	3	\$602

Grain runs the **length** of the worksurface. Tops 120" and under are shipped in one piece and require 2 bases. Tops 144" and over are shipped in two pieces and require 3 bases.

Required Specifications
Veneer Finish

Optional Specifications
Boardroom Table Base
Grommet

BOARDROOM TABLES - TOPS

MODEL# DIMENSIONS FREIGHT CLASS WT/LBS. CUBIC FT. LIST PRICE

D x W x H

REBE24054D	54 x 240 x 1.50	85	540	39	\$7213
REBE21654D	54 x 216 x 1.50	85	486	35	\$6551
REBE19254D	54 x 192 x 1.50	85	432	31	\$5718
REBE16848D	48 x 168 x 1.50	85	336	25	\$4389
REBE14448D	48 x 144 x 1.50	85	288	21	\$3473
REBE12048D	48 x 120 x 1.50	85	240	18	\$2950
REBE9648D	48 x 96 x 1.50	85	192	14	\$2288
REBE8442D	42 x 84 x 1.50	85	147	11	\$2084
REBE7242D	42 x 72 x 1.50	85	126	9	\$1834
REBE8436D	36 x 84 x 1.50	85	126	9	\$1834
REBE7236D	36 x 72 x 1.50	85	108	8	\$1570
REBE6636D	36 x 66 x 1.50	85	99	7	\$1200
REBE8430D	30 x 84 x 1.50	85	105	8	\$1528
REBE7230D	30 x 72 x 1.50	85	90	7	\$1311
REBE6630D	30 x 66 x 1.50	85	83	6	\$1200
REBE6030D	30 x 60 x 1.50	85	75	6	\$1088
REBE5430D	30 x 54 x 1.50	85	68	5	\$982

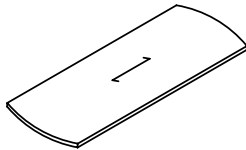

Rectangular Top - Bow Ends

Grain runs the **length** of the worksurface. Tops 120" and under are shipped in one piece and require 2 bases. Tops 144" and over are shipped in two pieces and require 3 bases.

RA24054D	54 x 240 x 1.50	85	540	39	\$8783
RA21654D	54 x 216 x 1.50	85	486	35	\$7418
RA19254D	54 x 192 x 1.50	85	432	31	\$7016
RA16848D	48 x 168 x 1.50	85	336	25	\$5251
RA14448D	48 x 144 x 1.50	85	288	21	\$4126
RA12048D	48 x 120 x 1.50	85	240	18	\$3661
RA9648D	48 x 96 x 1.50	85	192	14	\$2906
RA8442D	42 x 84 x 1.50	85	147	11	\$2632
RA7242D	42 x 72 x 1.50	85	126	9	\$2311
RA8436D	36 x 84 x 1.50	85	126	9	\$2389
RA7236D	36 x 72 x 1.50	85	108	8	\$2047
RA6636D	36 x 66 x 1.50	85	99	7	\$1565
RA8430D	30 x 84 x 1.50	85	105	8	\$1991
RA7230D	30 x 72 x 1.50	85	90	7	\$1709
RA6630D	30 x 66 x 1.50	85	83	6	\$1565
RA6030D	30 x 60 x 1.50	85	75	6	\$1422
RA5430D	30 x 54 x 1.50	85	68	5	\$1283
RA8422D	22 x 84 x 1.50	85	77	6	\$1593
RA7222D	22 x 72 x 1.50	85	66	5	\$1366
RA6622D	22 x 66 x 1.50	85	61	5	\$1250
RA6022D	22 x 60 x 1.50	85	55	4	\$1139
RA5422D	22 x 54 x 1.50	85	50	4	\$1024
RA4822D	22 x 48 x 1.50	85	44	3	\$987

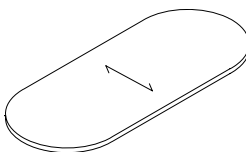

Racetrack Top - Cross Grain

Grain runs the **depth** of the worksurface. Tops 120" and under are shipped in one piece and require 2 bases. Tops 144" and over are shipped in two pieces and require 3 bases.

Required Specifications

Veneer Finish

Optional Specifications

Boardroom Table Base
Grommet

T BOARDROOM TABLES - DUFFERIN

BOARDROOM TABLES - TOPS

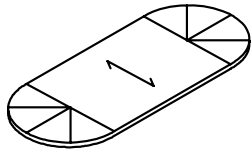

**Racetrack Top Cross Grain Center,
Sunburst Veneer Pattern on Left & Right**

MODEL#	DIMENSIONS	FREIGHT CLASS	WT/LBS.	CUBIC FT.	LIST PRICE
--------	------------	---------------	---------	-----------	------------

D x W x H

RA24054SD	54 x 240 x 1.50	85	540	39	\$9463
RA21654SD	54 x 216 x 1.50	85	486	35	\$8088
RA19254SD	54 x 192 x 1.50	85	432	31	\$7681
RA16848SD	48 x 168 x 1.50	85	336	25	\$5899
RA14448SD	48 x 144 x 1.50	85	288	21	\$4760
RA12048SD	48 x 120 x 1.50	85	240	18	\$4093
RA9648SD	48 x 96 x 1.50	85	192	14	\$3334
RA8442SD	42 x 84 x 1.50	85	147	11	\$2968
RA7242SD	42 x 72 x 1.50	85	126	9	\$2681
RA8436SD	36 x 84 x 1.50	85	126	9	\$2681
RA7236SD	36 x 72 x 1.50	85	108	8	\$2297
RA6636SD	36 x 66 x 1.50	85	99	7	\$1755
RA8430SD	30 x 84 x 1.50	85	105	8	\$2232
RA7230SD	30 x 72 x 1.50	85	90	7	\$1917
RA6630SD	30 x 66 x 1.50	85	83	6	\$1755
RA6030SD	30 x 60 x 1.50	85	75	6	\$1598
RA5430SD	30 x 54 x 1.50	85	68	5	\$1436
RA8422SD	22 x 84 x 1.50	85	77	6	\$1788
RA7222SD	22 x 72 x 1.50	85	66	5	\$1533
RA6622SD	22 x 66 x 1.50	85	61	5	\$1408
RA6022SD	22 x 60 x 1.50	85	55	4	\$1278
RA5422SD	22 x 54 x 1.50	85	50	4	\$1149
RA4822SD	22 x 48 x 1.50	85	44	3	\$1107

Grain runs the **depth** of the worksurface. Tops 120" and under are shipped in one piece and require 2 bases. Tops 144" and over are shipped in two pieces and require 3 bases.

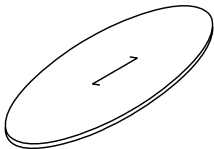

Oval Top

OV24054D	54 x 240 x 1.50	85	540	39	\$10979
OV21654D	54 x 216 x 1.50	85	486	35	\$9273
OV19254D	54 x 192 x 1.50	85	432	31	\$8770
OV16848D	48 x 168 x 1.50	85	336	25	\$6563
OV14448D	48 x 144 x 1.50	85	288	21	\$5158
OV12048D	48 x 120 x 1.50	85	240	18	\$4576
OV9648D	48 x 96 x 1.50	85	192	14	\$3632
OV8442D	42 x 84 x 1.50	85	147	11	\$3290
OV7242D	42 x 72 x 1.50	85	126	9	\$2888
OV8436D	36 x 84 x 1.50	85	126	9	\$2888
OV7236D	36 x 72 x 1.50	85	108	8	\$2476
OV6636D	36 x 66 x 1.50	85	99	7	\$1891
OV8430D	30 x 84 x 1.50	85	105	8	\$2491
OV7230D	30 x 72 x 1.50	85	90	7	\$2135
OV6630D	30 x 66 x 1.50	85	83	6	\$1959
OV6030D	30 x 60 x 1.50	85	75	6	\$1778
OV5430D	30 x 54 x 1.50	85	68	5	\$1602
OV8422D	22 x 84 x 1.50	85	77	6	\$1991
OV7222D	22 x 72 x 1.50	85	66	5	\$1709
OV6622D	22 x 66 x 1.50	85	61	5	\$1565
OV6022D	22 x 60 x 1.50	85	55	4	\$1422
OV5422D	22 x 54 x 1.50	85	50	4	\$1283
OV4822D	22 x 48 x 1.50	85	44	3	\$1232

Grain runs the **length** of the worksurface. Tops 120" and under are shipped in one piece and require 2 bases. Tops 144" and over are shipped in two pieces and require 3 bases.

Required Specifications

Veneer Finish

Optional Specifications

Boardroom Table Base

Grommet

BOARDROOM TABLES - TOPS

MODEL# DIMENSIONS FREIGHT CLASS WT/LBS. CUBIC FT. LIST PRICE

D x W x H

BO24054D	54 x 240 x 1.50	85	540	39	\$7144
BO21654D	54 x 216 x 1.50	85	486	35	\$6422
BO19254D	54 x 192 x 1.50	85	432	31	\$5695
BO16848D	48 x 168 x 1.50	85	336	25	\$4538
BO14448D	48 x 144 x 1.50	85	288	21	\$3672
BO12048D	48 x 120 x 1.50	85	240	18	\$3075
BO9648D	48 x 96 x 1.50	85	192	14	\$2496
BO8442D	42 x 84 x 1.50	85	147	11	\$2301
BO7242D	42 x 72 x 1.50	85	126	9	\$2028

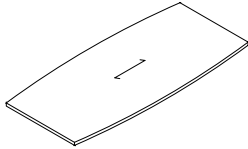

Boat Shape Top

Grain runs the **length** of the worksurface. Tops 120" and under are shipped in one piece and require 2 bases. Tops 144" and over are shipped in two pieces and require 3 bases.

BOBE24054D	54 x 240 x 1.50	85	540	39	\$8213
BOBE21654D	54 x 216 x 1.50	85	486	35	\$7385
BOBE19254D	54 x 192 x 1.50	85	432	31	\$6551
BOBE5454D	54 x 54 x 1.50	85	121	9	\$1843
BOBE16848D	48 x 168 x 1.50	85	336	25	\$5218
BOBE14448D	48 x 144 x 1.50	85	288	21	\$4218
BOBE12048D	48 x 120 x 1.50	85	240	18	\$3538
BOBE9648D	48 x 96 x 1.50	85	192	14	\$2871
BOBE4848D	48 x 48 x 1.50	85	96	7	\$1556
BOBE8442D	42 x 84 x 1.50	85	147	11	\$2649
BOBE7242D	42 x 72 x 1.50	85	126	9	\$2334
BOBE4242D	42 x 42 x 1.50	85	74	5	\$1357

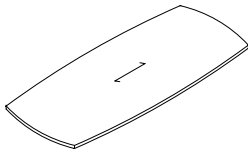

Boat Shape Top - Bow Ends

Grain runs the **length** of the worksurface. Tops 120" and under are shipped in one piece and require 2 bases. Tops 144" and over are shipped in two pieces and require 3 bases.

WE2405442D	54 - 42 x 240 x 1.50	85	540	39	\$6274
WE2165442D	54 - 42 x 216 x 1.50	85	486	35	\$5695
WE1925442D	54 - 42 x 192 x 1.50	85	432	31	\$4973
WE1684836D	48 - 36 x 168 x 1.50	85	336	25	\$3815
WE1444836D	48 - 36 x 144 x 1.50	85	288	21	\$3019
WE1204836D	48 - 36 x 120 x 1.50	85	240	18	\$2565
WE964836D	48 - 36 x 96 x 1.50	85	192	14	\$1987
WE844230D	42 - 30 x 84 x 1.50	85	147	11	\$1811
WE724230D	42 - 30 x 72 x 1.50	85	126	9	\$1593
WE843624D	36 - 24 x 84 x 1.50	85	126	9	\$1593
WE723624D	36 - 24 x 72 x 1.50	85	108	8	\$1366
WE663624D	36 - 24 x 66 x 1.50	85	99	7	\$1047

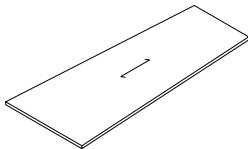

Wedge Shape Top

Grain runs the **length** of the worksurface. Tops 120" and under are shipped in one piece and require 2 bases. Tops 144" and over are shipped in two pieces and require 3 bases.

WEBE2405442D	54 - 42 x 240 x 1.50	85	540	39	\$7213
WEBE2165442D	54 - 42 x 216 x 1.50	85	486	35	\$6551
WEBE1925442D	54 - 42 x 192 x 1.50	85	432	31	\$5718
WEBE1684836D	48 - 36 x 168 x 1.50	85	336	25	\$4389
WEBE1444836D	48 - 36 x 144 x 1.50	85	288	21	\$3473
WEBE1204836D	48 - 36 x 120 x 1.50	85	240	18	\$2950
WEBE964836D	48 - 36 x 96 x 1.50	85	192	14	\$2288
WEBE844230D	42 - 30 x 84 x 1.50	85	147	11	\$2084
WEBE724230D	42 - 30 x 72 x 1.50	85	126	9	\$1834
WEBE843624D	36 - 24 x 84 x 1.50	85	126	9	\$1834
WEBE723624D	36 - 24 x 72 x 1.50	85	108	8	\$1570
WEBE663624D	36 - 24 x 66 x 1.50	85	99	7	\$1200

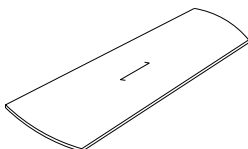

Wedge Shape Top - Bow Ends

Grain runs the **length** of the worksurface. Tops 120" and under are shipped in one piece and require 2 bases. Tops 144" and over are shipped in two pieces and require 3 bases.

Required Specifications

Veneer Finish

Optional Specifications

Boardroom Table Base
Grommet

T BOARDROOM TABLES - LUFTON

BOARDROOM TABLES - TOPS WITH LUFTON EDGE

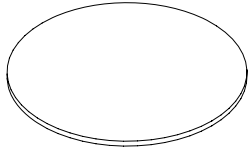

Round Top

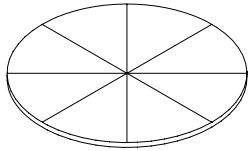

Round Top - Sunburst Veneer Pattern

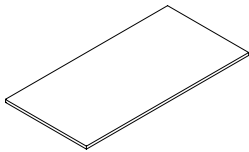

Rectangular Top

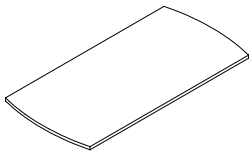

Rectangular Top - Bow Ends

MODEL#	DIMENSIONS D x W x H	FREIGHT CLASS	WT/LBS.	CUBIC FT.	LIST PRICE
RO60L	60 x 60 x 1.50	85	150	11	\$1941
RO48L	48 x 48 x 1.50	85	96	7	\$1548
RO42L	42 x 42 x 1.50	85	74	6	\$1396
RO36L	36 x 36 x 1.50	85	54	4	\$1243
RO30L	30 x 30 x 1.50	85	38	3	\$829

For use with Drum Base, Pedestal Base, Cross Base, Wood Post Legs, Metal Post Legs and 4 Prong Base.

RO60SL	60 x 60 x 1.50	85	150	11	\$2130
RO48SL	48 x 48 x 1.50	85	96	7	\$1751
RO42SL	42 x 42 x 1.50	85	74	6	\$1516
RO36SL	36 x 36 x 1.50	85	54	4	\$1366
RO30SL	30 x 30 x 1.50	85	38	3	\$1207

For use with Drum Base, Pedestal Base, "X" Shape Slab Base, Wood Post Legs, Metal Post Legs and 4 Prong Base.

RE24054L	54 x 240 x 1.50	85	540	39	\$6046
RE21654L	54 x 216 x 1.50	85	486	35	\$5486
RE19254L	54 x 192 x 1.50	85	432	31	\$4789
RE16848L	48 x 168 x 1.50	85	336	25	\$3673
RE14448L	48 x 144 x 1.50	85	288	21	\$2907
RE12048L	48 x 120 x 1.50	300	240	18	\$2471
RE9648L	48 x 96 x 1.50	85	192	14	\$1916
RE8442L	42 x 84 x 1.50	85	147	11	\$1745
RE7242L	42 x 72 x 1.50	85	126	9	\$1534
RE8436L	36 x 84 x 1.50	85	126	9	\$1534
RE7236L	36 x 72 x 1.50	85	108	8	\$1316
RE6636L	36 x 66 x 1.50	92.5	99	7	\$1007
RE8430L	30 x 84 x 1.50	85	105	8	\$1280
RE7230L	30 x 72 x 1.50	85	90	7	\$1098
RE6630L	30 x 66 x 1.50	85	83	6	\$1007
RE6030L	30 x 60 x 1.50	85	75	6	\$916
RE5430L	30 x 54 x 1.50	85	68	5	\$822
RE4830L	30 x 48 x 1.50	85	44	3	\$804

Grain runs the **length** of the worksurface. Tops 120" and under are shipped in one piece and require 2 bases. Tops 144" and over are shipped in two pieces and require 3 bases.

REBE24054L	54 x 240 x 1.50	85	540	39	\$6950
REBE21654L	54 x 216 x 1.50	85	486	35	\$6307
REBE19254L	54 x 192 x 1.50	85	432	31	\$5508
REBE16848L	48 x 168 x 1.50	85	336	25	\$4226
REBE14448L	48 x 144 x 1.50	85	288	21	\$3343
REBE12048L	48 x 120 x 1.50	300	240	18	\$2841
REBE9648L	48 x 96 x 1.50	85	192	14	\$2202
REBE8442L	42 x 84 x 1.50	85	147	11	\$2006
REBE7242L	42 x 72 x 1.50	85	126	9	\$1766
REBE8436L	36 x 84 x 1.50	85	126	9	\$1766
REBE7236L	36 x 72 x 1.50	85	108	8	\$1512

Grain runs the **length** of the worksurface. Tops 120" and under are shipped in one piece and require 2 bases. Tops 144" and over are shipped in two pieces and require 3 bases.

Required Specifications

Veneer Finish

Optional Specifications

Boardroom Table Base

Grommet

BOARDROOM TABLES - TOPS

MODEL# DIMENSIONS FREIGHT CLASS WT/LBS. CUBIC FT. LIST PRICE

D x W x H

RA24054L	54 x 240 x 1.50	85	540	39	\$8134
RA21654L	54 x 216 x 1.50	85	486	35	\$6950
RA19254L	54 x 192 x 1.50	85	432	31	\$6601
RA16848L	48 x 168 x 1.50	85	336	25	\$5068
RA14448L	48 x 144 x 1.50	85	288	21	\$4091
RA12048L	48 x 120 x 1.50	300	240	18	\$3517
RA9648L	48 x 96 x 1.50	85	192	14	\$2863
RA8442L	42 x 84 x 1.50	85	147	11	\$2580
RA7242L	42 x 72 x 1.50	85	126	9	\$2304
RA8436L	36 x 84 x 1.50	85	126	9	\$2304
RA7236L	36 x 72 x 1.50	85	108	8	\$1973
RA6636L	36 x 66 x 1.50	92.5	99	7	\$1508

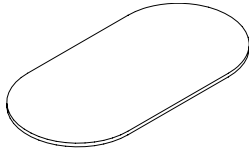

Racetrack Top - Cross Grain

Grain runs the **depth** of the worksurface. Tops 120" and under are shipped in one piece and require 2 bases. Tops 144" and over are shipped in two pieces and require 3 bases.

B024054L	54 x 240 x 1.50	85	540	39	\$6877
B021654L	54 x 216 x 1.50	85	486	35	\$6183
B019254L	54 x 192 x 1.50	85	432	31	\$5486
B016848L	48 x 168 x 1.50	85	336	25	\$4371
B014448L	48 x 144 x 1.50	85	288	21	\$3531
B012048L	48 x 120 x 1.50	85	240	18	\$2961
B09648L	48 x 96 x 1.50	85	192	14	\$2406
B08442L	42 x 84 x 1.50	85	147	11	\$2216
B07242L	42 x 72 x 1.50	85	126	9	\$1955

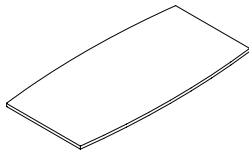

Boat Shape Top

Grain runs the **length** of the worksurface. Tops 120" and under are shipped in one piece and require 2 bases. Tops 144" and over are shipped in two pieces and require 3 bases.

BOBE24054L	54 x 240 x 1.50	85	540	39	\$7912
BOBE21654L	54 x 216 x 1.50	85	486	35	\$7113
BOBE19254L	54 x 192 x 1.50	85	432	31	\$6307
BOBE5454L	54 x 54 x 1.50	85	121	9	\$1774
BOBE16848L	48 x 168 x 1.50	85	336	25	\$5025
BOBE14448L	48 x 144 x 1.50	85	288	21	\$4066
BOBE12048L	48 x 120 x 1.50	85	240	18	\$3405
BOBE9648L	48 x 96 x 1.50	85	192	14	\$2090
BOBE4848L	48 x 48 x 1.50	85	96	7	\$1501
BOBE8442L	42 x 84 x 1.50	85	147	11	\$2326
BOBE7242L	42 x 72 x 1.50	85	126	9	\$2246
BOBE4242L	42 x 42 x 1.50	85	74	5	\$1312

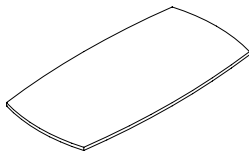

Boat Shape Top - Bow Ends

Grain runs the **length** of the worksurface. Tops 120" and under are shipped in one piece and require 2 bases. Tops 144" and over are shipped in two pieces and require 3 bases.

Required Specifications

Veneer Finish

Optional Specifications

Boardroom Table Base
Grommet

T BOARDROOM TABLES - LUFTON

BOARDROOM TABLES - TOPS

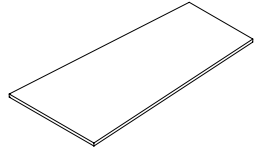

Wedge Shape Top

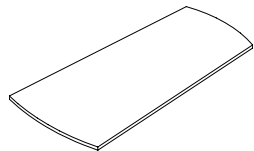

Wedge Shape Top - Bow Ends

MODEL#	DIMENSIONS D x W x H	FREIGHT CLASS	WT/LBS.	CUBIC FT.	LIST PRICE
WE2405442L	54 - 42 x 240 x 1.50	85	540	39	\$6046
WE2165442L	54 - 42 x 216 x 1.50	85	486	35	\$5486
WE1925442L	54 - 42 x 192 x 1.50	85	432	31	\$4789
WE1684836L	48 - 36 x 168 x 1.50	85	336	25	\$3673
WE1444836L	48 - 36 x 144 x 1.50	85	288	21	\$2907
WE1204836L	48 - 36 x 120 x 1.50	85	240	18	\$2471
WE964836L	48 - 36 x 96 x 1.50	85	192	14	\$2395
WE844230L	42 - 30 x 84 x 1.50	85	147	11	\$1745
WE724230L	42 - 30 x 72 x 1.50	85	126	9	\$1534

Grain runs the **length** of the worksurface. Tops 120" and under are shipped in one piece and require 2 bases. Tops 144" and over are shipped in two pieces and require 3 bases.

WEBE2405442L	54 - 42 x 240 x 1.50	85	540	39	\$6950
WEBE2165442L	54 - 42 x 216 x 1.50	85	486	35	\$6307
WEBE1925442L	54 - 42 x 192 x 1.50	85	432	31	\$5508
WEBE1684836L	48 - 36 x 168 x 1.50	85	336	25	\$4226
WEBE1444836L	48 - 36 x 144 x 1.50	85	288	21	\$3343
WEBE1204836L	48 - 36 x 120 x 1.50	85	240	18	\$2841
WEBE964836L	48 - 36 x 96 x 1.50	85	192	14	\$2202
WEBE844230L	42 - 30 x 84 x 1.50	85	147	11	\$2006
WEBE724230L	42 - 30 x 72 x 1.50	85	126	9	\$1766

Grain runs the **length** of the worksurface. Tops 120" and under are shipped in one piece and require 2 bases. Tops 144" and over are shipped in two pieces and require 3 bases.

Required Specifications

Veneer Finish

Optional Specifications

Boardroom Table Base

Grommet

BOARDROOM TABLE BASES - ALL SERIES

MODEL# DIMENSIONS FREIGHT CLASS WT/LBS. CUBIC FT. LIST PRICE

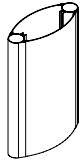

Elliptical Base

D x W x H						
TE42	8 x 42 x 28	100	70	8		\$1248
TE36	7 x 36 x 28	92.5	60	6		\$1248
TE36	7 x 36 x 28	92.5	60	6		\$1248
TE30	6 x 30 x 28	85	50	4		\$1207
TE24	6 x 24 x 28	70	40	2		\$1159

Not to be used with round table tops. For tops up to 120", two Elliptical Bases must be ordered. For tops 144" and more, three Elliptical Bases must be ordered.

• **Plastic End Gables are available in a Tungsten (K) or Black (E) finish. Please Specify.**

- For 30" and 36" deep tops, order a 24" base (**TE24**).
- For 42" and 48" deep tops, order a 30" base (**TE30**).
- For 54" and 60" deep tops, order a 36" base (**TE36**) or 42" base (**TE42**).

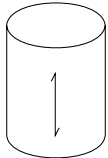

Drum Base - Veneer

TD30	30 x 30 x 28	125	93	15		\$2036
TD22	22 x 22 x 28	100	70	8		\$980
TD18	18 x 18 x 28	85	62	5		\$852

For tops up to 120", two Drum Bases must be ordered. For tops 144" and more, three Drum Bases must be ordered. Sand bag included to provide adequate stability.

- For 30", 36" and 42" deep tops, order a 18" base (**TD18**).
- For 48" and 54" deep tops, order a 22" base (**TD22**).
- For 60" deep tops, order a 30" base (**TD30**).

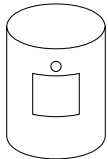

Drum Base with Power Access Door - Veneer

TD30J	30 x 30 x 28	125	93	15		\$2546
TD22J	22 x 22 x 28	100	70	8		\$1491
TD18J	18 x 18 x 28	85	62	5		\$1363

Access door and top and bottom cut-out to accommodate power/data grommet. For tops up to 120", two Drum Bases must be ordered. For tops 144" and more, three Drum Bases must be ordered. Sand bag included to provide adequate stability.

- Power access door is 12" x 12"
- For 30", 36" and 42" deep tops, order a 18" base (**TD18J**).
- For 48" and 54" deep tops, order a 22" base (**TD22J**).
- For 60" deep tops, order a 30" base (**TD30J**).

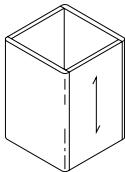

Pedestal Base

TP24	24 x 24 x 28	92.5	106	10		\$1065
TP20	20 x 20 x 28	85	89	7		\$1022
TP16	16 x 16 x 28	70	71	4		\$980

For tops up to 120", two Pedestal Bases must be ordered. For tops 144" and more, three Pedestal Bases must be ordered.

- For 30", 36" and 42" deep tops, order a 16" base (**TP16**).
- For 48" and 54" deep tops, order a 20" base (**TP20**).
- For 60" deep tops, order a 24" base (**TP24**).

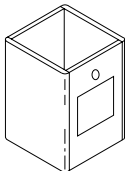

Pedestal Base with Power Access Door

TP24J	24 x 24 x 28	92.5	106	10		\$1576
TP20J	20 x 20 x 28	85	89	7		\$1533
TP16J	16 x 16 x 28	70	71	4		\$1491

Access door and top and bottom cut-out to accommodate power/data grommet. For tops up to 120", two Pedestal Bases must be ordered. For tops 144" and more, three Pedestal Bases must be ordered.

- Power access door is 12" x 12"
- For 30", 36" and 42" deep tops, order a 16" base (**TP16J**).
- For 48" and 54" deep tops, order a 20" base (**TP20J**).
- For 60" deep tops, order a 24" base (**TP24J**).

Required Specifications

Veneer Finish

T BOARDROOM TABLES

BOARDROOM TABLE BASES - ALL SERIES

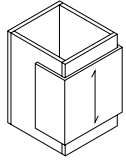

**Pedestal Base - Veneer
Decorative Outside Panel***

MODEL#	DIMENSIONS D x W x H	FREIGHT CLASS	WT/LBS.	CUBIC FT.	LIST PRICE	ALL VENEER
TPM24	24 x 24 x 28	92.5	106	10	\$1649	\$1979
TPM20	20 x 20 x 28	85	86	7	\$1580	\$1896
TPM16	16 x 16 x 28	70	71	4	\$1517	\$1821

For tops up to 120", two Pedestal Bases must be ordered. For tops 144" and more, three Pedestal Bases must be ordered.

- For 30", 36" and 42" deep tops, order a 16" base (**TPM16**).
- For 48" and 54" deep tops, order a 20" base (**TPM20**).
- For 60" deep tops, order a 24" base (**TPM24**).

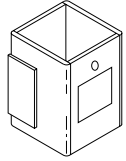

**Pedestal Base with Power Access Door
Veneer Decorative Outside Panel***

TPM24J	24 x 24 x 28	92.5	106	10	\$1917	\$2301
TPM20J	20 x 20 x 28	85	86	7	\$1848	\$2218
TPM16J	16 x 16 x 28	70	71	4	\$1861	\$2234

Access door and top and bottom cut-out to accommodate power/data grommet. For tops up to 120", two Pedestal Bases must be ordered. For tops 144" and more, three Pedestal Bases must be ordered.

- Power access door is 12" x 12"
- For 30", 36" and 42" deep tops, order a 16" base (**TPM16J**).
- For 48" and 54" deep tops, order a 20" base (**TPM20J**).
- For 60" deep tops, order a 24" base (**TPM24J**).

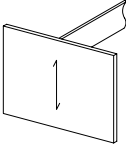

Slab Base

TH42	3 x 42 x 28	60	148	2	\$1493
TH36	3 x 36 x 28	60	127	2	\$1347
TH30	3 x 30 x 28	60	106	2	\$980
TH22	3 x 22 x 28	60	89	2	\$849

Not to be used with round table tops. For tops up to 120", two Slab Bases must be ordered. For tops 144" and more, three Slab Bases must be ordered.

- For 30" and 36" deep tops, order a 22" base (**TH22**).
- For 42" and 48" deep tops, order a 30" base (**TH30**).
- For 54" deep tops, order a 36" base (**TH36**).
- For 60" deep tops, order a 42" base (**TH42**).

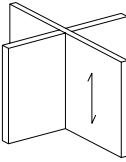

Cross Base

TX42	3 x 42 x 28	100	180	20	\$1440
TX36	3 x 36 x 28	100	155	17	\$1347
TX30	3 x 30 x 28	100	133	15	\$980
TX22	3 x 22 x 28	100	97	11	\$849

For tops up to 120", two Cross Bases must be ordered. For tops 144" and more, three Cross Bases must be ordered.

- For 30" and 36" deep tops, order a 22" base (**TX22**).
- For 42" and 48" deep tops, order a 30" base (**TX30**).
- For 54" deep tops, order a 36" base (**TX36**).
- For 60" deep tops, order a 42" base (**TX42**).

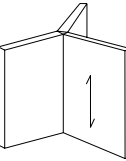

"Y" Base

TW42	4 x 42 x 28	125	140	20	\$1248
TW36	4 x 36 x 28	125	120	17	\$1099
TW30	4 x 30 x 28	125	100	15	\$901
TW22	4 x 22 x 28	125	73	11	\$843

Not to be used with round table tops. For tops up to 120", two "Y" Bases must be ordered. For tops 144" and more, two "Y" Bases and one Cross Base must be ordered.

- For 30" and 36" deep tops, order a 22" base (**TW22**).
- For 42" and 48" deep tops, order a 30" base (**TW30**).
- For 54" deep tops, order a 36" base (**TW36**).
- For 60" deep tops, order a 42" base (**TW42**).

Required Specifications

Veneer Finish

* Laminate Finish

BOARDROOM TABLE BASES - ALL SERIES

MODEL# DIMENSIONS FREIGHT CLASS WT/LBS. CUBIC FT. LIST PRICE

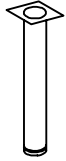

Post Leg Veneer

D x W x H						
SN06	6 dia x 28	250	10	3		\$1025
SN04	4 dia x 28	125	7	1		\$788
SN03	3 dia x 28	150	5	1		\$498

Available in 3", 4" and 6" diameters. Round tops and tops up to 96" require four legs. Tops 108" to 168" require six legs; tops 180" to 240" require ten legs.

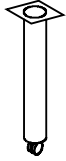

Post Leg Veneer w/Caster

SN06M	6 dia x 28	100	10	3		\$1083
SN04M	4 dia x 28	125	7	1		\$847
SN03M	3 dia x 28	150	5	1		\$555

Available in 3", 4" and 6" diameters. Caster included. Round tops and tops up to 96" require four legs. Tops 108" to 168" require six legs; tops 180" to 240" require ten legs.

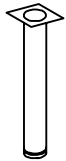

Post Leg Metal

SM06	6 dia x 28	100	10	3		\$699
SM04	4 dia x 28	125	7	1		\$384
SM03	3 dia x 28	150	5	1		\$274

Available in 3", 4" and 6" diameters. Round tops and tops up to 96" require four legs. Tops 108" to 168" require six legs; tops 180" to 240" require ten legs.

• **Must Specify Black (E) or Tungsten (K) finish**

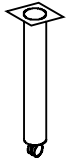

Post Leg Metal w/Casters

SM06M	6 dia x 28	100	10	3		\$759
SM04M	4 dia x 28	125	7	1		\$444
SM03M	3 dia x 28	150	5	1		\$333

Available in 3", 4" and 6" diameters. Caster included. Round tops and tops up to 96" require four legs. Tops 108" to 168" require six legs; tops 180" to 240" require ten legs.

• **Must Specify Black (E) or Tungsten (K) finish**

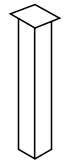

Post Leg Metal, Square

SMS4	4 x 4 x 28	125	7	1		\$301
------	------------	-----	---	---	--	--------------

Available in 4". Round tops and tops up to 96" require four legs. Tops 108" to 168" require six legs; tops 180" to 240" require ten legs.

• **Must Specify Black (E) or Tungsten (K) finish**

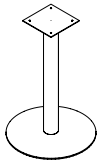

Post Leg w/Flat Plate

F6P36	36 x 36 x 28	150	100	22		\$2409
F4P30	30 x 30 x 28	150	80	15		\$1466
F4P24	24 x 24 x 28	125	60	10		\$1170
F3P18	18 x 18 x 28	100	45	5		\$1038

Round tops require a single base. For tops up to 120", two bases must be ordered. For tops 144" or more, three bases must be ordered.

• **Must Specify Black (E) or Tungsten (K) finish**

- For 30" deep tops, order a 18" base (**F3P18**).
- For 36" deep tops, order a 24" base (**F4P24**).
- For 42" and 48" deep tops, order a 30" base (**F4P30**).
- For 54" deep tops, order a 36" base (**F6P36**).

Required Specifications

Veneer Finish (Veneer Post Legs)

Metal Finish (Metal Legs)

T BOARDROOM TABLES

BOARDROOM TABLE BASES - ALL SERIES

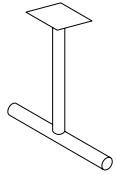

Tubular 2-Prong Base

MODEL#	DIMENSIONS D x W x H	FREIGHT CLASS	WT/LBS.	CUBIC FT.	LIST PRICE
TTM36	36 x 36 x 28	100	28	22	\$578
TTM26	26 x 26 x 28	85	24	11	\$554

Not to be used with round table tops. Two square edged prongs. For tops up to 84", two Tubular 2-Prong Bases must be ordered. Used as a 3rd base to provide center support in conjunction with two 3-Prong bases on tops 144" or more.

• **Must Specify Black (E) or Tungsten (K) finish**

- For 30", 36" and 42" deep tops, order a 26" base (**TTM26**).
- For 48", 54" and 60" deep tops, order a 36" base (**TTM36**).

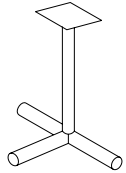

Tubular 3-Prong Base

TTE36	36 x 36 x 28	250	36	22	\$616
TTE26	26 x 26 x 28	85	32	11	\$549

Not to be used with round table tops. Three square edged prongs. For tops up to 120", two Tubular 3-Prong Bases must be ordered. For tops 144" and more, two Tubular 3-Prong Bases and one Tubular 2-Prong Base for the center must be ordered.

• **Must Specify Black (E) or Tungsten (K) finish**

- For 30", 36" and 42" deep tops, order a 26" base (**TTE26**).
- For 48", 54" and 60" deep tops, order a 36" base (**TTE36**).

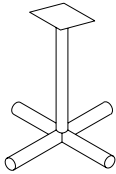

Tubular 4-Prong Base

TT36	36 x 36 x 28	300	40	22	\$924
TT26	26 x 26 x 28	250	36	11	\$635

Four square edged prongs. For tops up to 120", two Tubular 4-Prong Bases must be ordered. For tops 144" and more, three Tubular 4-Prong Bases must be ordered.

• **Must Specify Black (E) or Tungsten (K) finish**

- For 30", 36" and 42" deep tops, order a 26" base (**TT26**).
- For 48" and 54" deep tops, order a 36" base (**TT36**)*

* Maximum diameter for Round Tops is 54".

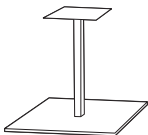

Flat Square Column Base

TTSQ23BH	23 x 23 x 41	150	75	14	\$2308
TTSQ18BH	18 x 18 x 41	125	65	10	\$2137
TTSQ30	30 x 30 x 28	150	80	14	\$2394
TTSQ23	23 x 23 x 28	150	55	12	\$1966
TTSQ18	18 x 18 x 28	150	45	8	\$1795

Round tops require a single base. For tops up to 120", two bases must be ordered. For tops 144" or more, three bases must be ordered.

• **Must Specify Black (E) or Tungsten (K) finish**

- For 30" deep tops, order a 18" base (**TTSQ18** or **TTSQ18BH**).
- For 36" deep tops, order a 24" base (**TTSQ23** or **TTSQ23BH**).
- For 42" and 48" deep tops, order a 30" base (**TTSQ30**).
 - Max diameter for round tops at standard height is 48".
 - Max diameter for round tops at bar height is 36".

Required Specifications

Metal Finish (Metal Legs)

BOARDROOM TABLE BASES - ALL SERIES

MODEL# DIMENSIONS FREIGHT CLASS WT/LBS. CUBIC FT. LIST PRICE

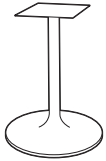

Trumpet Column Base

	D x W x H				
TRUM24BH	24 x 24 x 41	300	26	14	\$1112
TRUM18BH	18 x 18 x 41	300	24	16	\$1026
TRUM30	30 x 30 x 28	300	18	14	\$1069
TRUM24	24 x 24 x 28	300	16	12	\$770
TRUM18	18 x 18 x 28	300	14	8	\$684

Round tops require a single base. For tops up to 120", two bases must be ordered. For tops 144" or more, three bases must be ordered.

- **Must Specify Black (E) or Tungsten (K) finish**
- For 30" deep tops, order a 18" base (**TRUM18** or **TRUM18BH**).
- For 36" deep tops, order a 24" base (**TRUM24** or **TRUM24BH**).
- For 42" and 48" deep tops, order a 30" base (**TRUM30**).
 - Max diameter for round tops at standard height is 48".
 - Max diameter for round tops at bar height is 36".

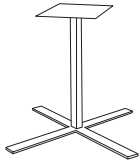

Flat Bar "X" Column Base

TTFLT36	36 x 36 x 28	300	18	14	\$2137
TTFLT30	30 x 30 x 28	300	16	12	\$2052
TTFLT22	22 x 22 x 28	300	15	10	\$1889

Round tops require a single base. For tops up to 120", two bases must be ordered. For tops 144" or more, three bases must be ordered.

- **Must Specify Black (E) or Tungsten (K) finish**
- For 30" and 36" deep tops, order a 22" base (**TTFLT22**).
- For 42" and 48" deep tops, order a 30" base (**TTFLT30**).
- For 54" deep tops, order a 36" base (**TTFLT36**).

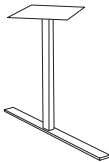

Flat Bar "T" Column Base

TTFLT36	36 x 36 x 28	150	14	3	\$1795
TTFLT24	24 x 24 x 28	150	10	2.50	\$1624

Not to be used with round table tops. For tops up to 84", two bases must be ordered. To be used as a 3rd base for center support in conjunction with two 3-prong bases on tops 144" or more.

- **Must Specify Black (E) or Tungsten (K) finish**
- For 30", 36" and 42" deep tops, order a 24" base (**TTFLT24**).
- For 48" and 54" deep tops, order a 36" base (**TTFLT36**).
- TTFLTxx bases are to be used as a middle base in combination with two TTFL3P bases



Flat Bar 3 Prong Column Base

TTFL3P36	36 x 36 x 28	400	16	22	\$2052
TTFL3P24	24 x 24 x 28	400	12	14	\$1881

Not to be used with round table tops. For tops up to 120", two bases must be ordered. For tops 144" or more, two 3-prong bases and one "T" column base must be ordered.

- **Must Specify Black (E) or Tungsten (K) finish**
- For 30", 36" and 42" deep tops, order a 24" base (**TTFL3P24**).
- For 48" and 54" deep tops, order a 36" base (**TTFL3P36**).
- When a third base is required, a TTFLTxx base may be used as the center base

Required Specifications

Metal Finish

T BOARDROOM TABLES

BOARDROOM TABLE BASES

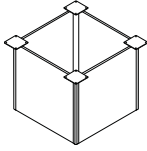

Square Panel Base - Anodized Aluminum Radius Corner Detail

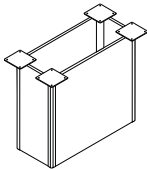

Rectangular Panel Base - Anodized Aluminum Radius Corner Detail

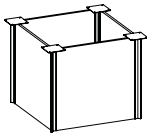

Square Panel Base - Anodized Aluminum Radius Corner Detail

MODEL#	DIMENSIONS D x W x H	FREIGHT CLASS	WT/LBS.	CUBIC FT.	LIST PRICE
TELRS36J	36 x 36 x 28	150	127	22	\$2513
TELRS30J	30 x 30 x 28	150	106	18	\$2129
TELRS24J	24 x 24 x 28	100	75	8	\$1727
TELRS20J	20 x 20 x 28	92.5	70	6	\$1488
TELRS16J	16 x 16 x 28	70	65	4	\$1351
TELRS36	36 x 36 x 28	150	127	22	\$2300
TELRS30	30 x 30 x 28	150	106	18	\$1915
TELRS24	24 x 24 x 28	100	75	8	\$1513
TELRS20	20 x 20 x 28	92.5	70	6	\$1274
TELRS16	16 x 16 x 28	70	65	4	\$1137

Round tops require a single base. For tops up to 120" two Square Panel bases must be ordered. For tops 144" or more, three bases must be ordered.

- **Model #'s with a "J" denote a power access door on one panel.**
- For 24" deep tops, order a 16" base (**TELRS16** or **TELRS16J**).
- For 30" deep tops, order a 20" base (**TELRS20** or **TELRS20J**).
- For 36" deep tops, order a 24" base (**TELRS24** or **TELRS24J**).
- For 42" and 48" deep tops, order a 30" base (**TELRS30** or **TELRS30J**).
- For 54" and 60" deep tops, order a 36" base (**TELRS36** or **TELRS36J**).

TELRR36J	12 x 36 x 28	100	117	12	\$2428
TELRR30J	12 x 30 x 28	100	95	10	\$2043
TELRR24J	12 x 24 x 28	100	65	8	\$1642
TELRR20J	12 x 20 x 28	92.5	60	6	\$1402
TELRR16J	12 x 16 x 28	85	50	4	\$1265
TELRR36	12 x 36 x 28	100	117	12	\$2214
TELRR30	12 x 30 x 28	100	95	10	\$1830
TELRR24	12 x 24 x 28	100	65	8	\$1428
TELRR20	12 x 20 x 28	92.5	60	6	\$1189
TELRR16	12 x 16 x 28	85	50	4	\$1052

Not to be used with round table tops. For tops up to 96" two Rectangular Panel bases must be ordered. To be used as a 3rd base for center support in conjunction with two Square Panel bases on tops 144" or more.

- **Model #'s with a "J" denote a power access door on one panel.**
- For 24" deep tops, order a 16" base (**TELRR16** or **TELRR16J**).
- For 30" deep tops, order a 20" base (**TELRR20** or **TELRR20J**).
- For 36" deep tops, order a 24" base (**TELRR24** or **TELRR24J**).
- For 42" and 48" deep tops, order a 30" base (**TELRR30** or **TELRR30J**).
- For 54" and 60" deep tops, order a 36" base (**TELRR36** or **TELRR36J**).

TELBS36J	36 x 36 x 28	100	117	12	\$2513
TELBS30J	30 x 30 x 28	100	95	10	\$2129
TELBS24J	24 x 24 x 28	100	65	8	\$1727
TELBS20J	20 x 20 x 28	92.5	60	6	\$1488
TELBS16J	16 x 16 x 28	85	50	4	\$1351
TELBS36	36 x 36 x 28	100	117	12	\$2300
TELBS30	30 x 30 x 28	100	95	10	\$1915
TELBS24	24 x 24 x 28	100	65	8	\$1513
TELBS20	20 x 20 x 28	92.5	60	6	\$1274
TELBS16	16 x 16 x 28	85	50	4	\$1137

Round tops require a single base. For tops up to 120" two Square Panel bases must be ordered. For tops 144" or more, three bases must be ordered.

- **Model #'s with a "J" denote a power access door on one panel.**
- For 24" deep tops, order a 16" base (**TELBS16** or **TELBS16J**).
- For 30" deep tops, order a 20" base (**TELBS20** or **TELBS20J**).
- For 36" deep tops, order a 24" base (**TELBS24** or **TELBS24J**).
- For 42" and 48" deep tops, order a 30" base (**TELBS30** or **TELBS30J**).
- For 54" and 60" deep tops, order a 36" base (**TELBS36** or **TELBS36J**).

Required Specifications

Finish

BOARDROOM TABLE BASES

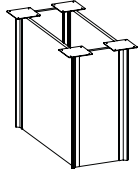

Rectangular Panel Base - Anodized Aluminum Radius Corner Detail

MODEL#	DIMENSIONS D x W x H	FREIGHT CLASS	WT/LBS.	CUBIC FT.	LIST PRICE
TELBR36J	12 x 36 x 28	100	117	12	\$2428
TELBR30J	12 x 30 x 28	100	95	10	\$2043
TELBR24J	12 x 24 x 28	100	65	8	\$1642
TELBR20J	12 x 20 x 28	92.5	60	6	\$1402
TELBR16J	12 x 16 x 28	85	50	4	\$1265
TELBR36	12 x 36 x 28	100	117	12	\$2214
TELBR30	12 x 30 x 28	100	95	10	\$1830
TELBR24	12 x 24 x 28	100	65	8	\$1428
TELBR20	12 x 20 x 28	92.5	60	6	\$1189
TELBR16	12 x 16 x 28	85	50	4	\$1052

Not to be used with round table tops. For tops up to 96" two Rectangular Panel bases must be ordered. To be used as a 3rd base for center support in conjunction with two Square Panel bases on tops 144" or more.

- **Model #'s with a "J" denote a power access door on one panel.**
- For 24" deep tops, order a 16" base (**TELBR16** or **TELBR16J**).
- For 30" deep tops, order a 20" base (**TELBR20** or **TELBR20J**).
- For 36" deep tops, order a 24" base (**TELBR24** or **TELBR24J**).
- For 42" and 48" deep tops, order a 30" base (**TELBR30** or **TELBR30J**).
- For 54" and 60" deep tops, order a 36" base (**TELBR36** or **TELBR36J**).

BOARDROOM - ACCESSORIES

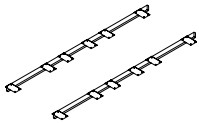

Metal Support Rails

TSUP102	1 x 102 x 2	70	0.10	0.10	\$785
TSUP96	1 x 96 x 2	70	0.10	0.10	\$735
TSUP90	1 x 90 x 2	70	0.10	0.10	\$682
TSUP84	1 x 84 x 2	70	0.10	0.10	\$629
TSUP78	1 x 78 x 2	70	0.10	0.10	\$576
TSUP72	1 x 72 x 2	70	0.10	0.10	\$524
TSUP66	1 x 66 x 2	70	0.10	0.10	\$472
TSUP60	1 x 60 x 2	70	0.10	0.10	\$421
TSUP54	1 x 54 x 2	70	0.10	0.10	\$386

To be used when design considerations or dimension requirements dictate an unsupported table joint. Top section **MUST NOT** exceed 72" to use metal supports. **Sold in sets of two**

- **Available in Black only.**

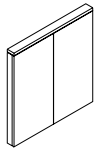

Visual Board

VB4848E	5 x 48 x 48	70	115	7	\$2883
---------	-------------	----	-----	---	--------

Includes porcelain on steel magnetic board and two side opening straight edge doors containing tackable fabric panels and 50-sheet paper writing pad that can be used on either door. Magnetic board can be used for projection. Set of 6 dry erase markers and eraser included.

- **NOTE:** Care should be taken to mount the units. Units should be mounted to wall studs using correct fasteners. Failure to do so may result in collapse of the unit and subsequent personal injury. **Mounting hardware not included.** Mounting hardware used should be based on wall material. Consult an installation professional for proper wall mounting.

Optional projection screen

Flipchart

Simple installation, flush to wall.

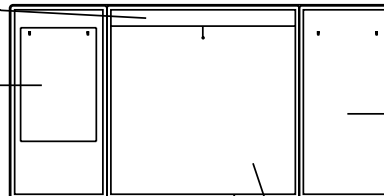

Set of 6 dry erase markers and dry erase brush included.

Tackable fabric panel. (Optional)

Shelf for markers and brush

White color, quality porcelain on steel. Provides excellent writing and magnetic surface.

Required Specifications

Finish

T BOARDROOM TABLES

BOARDROOM - ACCESSORIES

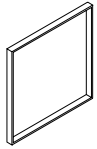

Visual Board - No Doors

MODEL#	DIMENSIONS D x W x H	FREIGHT CLASS	WT/LBS.	CUBIC FT.	LIST PRICE	
VB48480	5 x 48 x 48	70	115	7	\$1697	

Includes porcelain on steel magnetic board. Magnetic board can be used for projection. Set of 6 dry erase markers and eraser included.

- **NOTE:** Care should be taken to mount the units. Units should be mounted to wall studs using correct fasteners. Failure to do so may result in collapse of the unit and subsequent personal injury. **Mounting hardware not included.** Mounting hardware used should be based on wall material. Consult an installation professional for proper wall mounting.

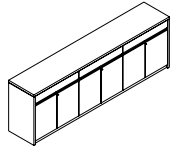

Credenza Buffet - Dufferin

DCB9022H36	22 x 90 x 36	92.5	440	44	\$6184	\$7421
DCB9020H36	20 x 90 x 36	92.5	400	40	\$5622	\$6747
DCB7222H36	22 x 72 x 36	92.5	330	33	\$4198	\$5038
DCB7220H36	20 x 72 x 36	92.5	300	30	\$3741	\$4490
DCB6022H36	22 x 60 x 36	100	275	28	\$3601	\$4322
DCB6020H36	20 x 60 x 36	92.5	250	25	\$3272	\$3927

90" w units have (3) two door storage cabinets with top drawer side-by-side. 72" w & 60" w units have (2) two door storage cabinets with top drawer side-by-side. Locking doors. Self-closing hinged doors cover one adjustable shelf.

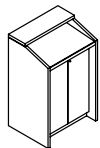

Lectern - Dufferin

DLEC3624	24 x 36 x 48	92.5	240	24	\$2928	\$3514
DLEC3024	24 x 30 x 48	92.5	200	20	\$2441	\$2930
DLEC2424	24 x 24 x 48	92.5	160	16	\$1951	\$2342

Features angled stand. Storage compartment with one adjustable and one fixed shelf. Locking doors.

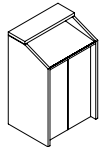

Lectern - Lufton

LEC3624L	24 x 36 x 48	92.5	240	24	\$3321	
LEC3024L	24 x 30 x 48	92.5	200	20	\$2769	
LEC2424L	24 x 24 x 48	92.5	160	16	\$2206	

Features angled stand. Storage compartment with one adjustable and one fixed shelf. Locking doors.

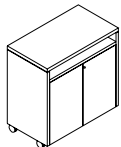

Utility Table

DTV3620M	20 x 36 x 34	85	121	10	\$1770	\$1770
----------	--------------	----	-----	----	---------------	---------------

Open shelf and storage compartment with one adjustable shelf. Locking doors. Casters.

Required Specifications

Finish

ACCESSORIES

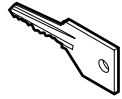

Extra Key

MODEL#	DIMENSIONS D x W x H	FREIGHT CLASS	WT/LBS.	CUBIC FT.	LIST PRICE
LOCK	--	70	--	--	\$10

Specify key #. Key range 400 - 500.



Grommet Cover Round

GM1	2 dia x --	70	--	--	\$42
GM1K	2 dia x --	70	--	--	\$42

2.75" diameter.

- **Specify GM1 for Black or GM1K for Tungsten.**

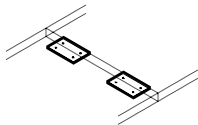

Mending Plates

MP53	3 x 5 x 0.50	300	3	2	\$38
------	--------------	-----	---	---	-------------

Sold in sets of 2.

- **Available in Black Only.**

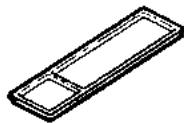

Pencil Tray - Black Plastic

PT	3 x 12.50 x 1	250	2	1	\$12
----	---------------	-----	---	---	-------------

Provides space for writing instruments and small items at the workspace.

- **Available in Black Only.**



Pencil Tray - Veneer

OPT	6 x 12.50 x 2	150	4	1	\$114
-----	---------------	-----	---	---	--------------

Provides space for writing instruments and small items at the workspace. Solid oak finish.

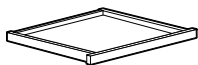

Center Drawer - Veneer

CD	21 x 23 x 2	100	8	1	\$470
----	-------------	-----	---	---	--------------

Veneer drawer front is attached to a 4-sided frame. Must specify wood finish for drawer front.

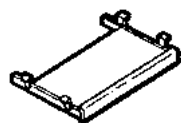

Keyboard Drawer

KD30	10 x 30 x 1	70	16	1	\$632
KD22	10 x 22 x 1	85	12	1	\$565
KD10	10 x 10 x 1	125	6	1	\$284

Pull-out veneer keyboard shelf. Clearance is 2 1/4". Must specify wood finish for drawer front.

Required Specifications

Finish

T BOARDROOM TABLES

KEYBOARD DRAWERS

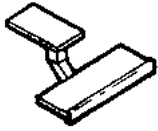

Articulating Keyboard Drawer

MODEL#	DIMENSIONS D x W x H	FREIGHT CLASS	WT/LBS.	CUBIC FT.	LIST PRICE
AKD30	10 x 30 x 1	65	24	1	\$875
AKD22	10 x 22 x 1	70	18	1	\$810

Adjustable pull-out keyboard shelf with articulating arm. Adjusts from flush with the worksurface to 5" below worksurface. Swivels 360° full arm rotation, angles -10° to +15°. Must specify wood finish for keyboard deck.

WIRE MANAGEMENT



Wire Management Cover

WH24	1 x 1 x 24	70	1	1	\$49
------	------------	----	---	---	-------------

To conceal wires and cords. Plastic.

• **Available in Black Plastic Only.**

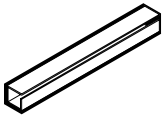

Wire Management Track - Single

C2M72	2 x 72 x 2	70	0.10	0.10	\$53
C2M60	2 x 60 x 2	70	0.10	0.10	\$44
C2M48	2 x 48 x 2	70	0.10	0.10	\$35
C2M36	2 x 36 x 2	70	0.10	0.10	\$26
C2M24	2 x 24 x 2	70	0.10	0.10	\$18
C2M12	2 x 12 x 2	70	0.10	0.10	\$9

To conceal and organize wires and cords. Attaches to Modesty Panel with double sided tape. Plastic.

• **Available in Black Plastic Only.**

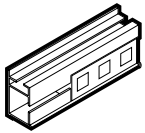

Wire Management Track - Double

CM72	2 x 72 x 4	70	0.10	0.10	\$148
CM60	2 x 60 x 4	70	0.10	0.10	\$121
CM48	2 x 48 x 4	70	0.10	0.10	\$99
CM36	2 x 36 x 4	70	0.10	0.10	\$76
CM24	2 x 24 x 4	70	0.10	0.10	\$50
CM12	2 x 12 x 4	70	0.10	0.10	\$27

To conceal and organize wires and cords. Attaches to Modesty Panel with double sided tape. Plastic.

• **Available in Black Plastic Only.**

Required Specifications

Finish

textiles and finishes

Care and Cleaning

Textiles

Fabrics: To extend the life of your seating upholstered in fabric, regularly dust the chair to prevent airborne particles from penetrating the fabric surface.

For light soiling, use a damp cloth and blot the spot with very slight pressure, taking care never to soak the fabric. Dry with a clean cloth by blotting - never rub fabric. More intense stains can be treated the same way, but with a mild detergent. Always test fabric first in an unseen area before using any cleaning method.

Leather: For regular cleaning, simply use a soft damp cloth, taking care not to soak the leather. For more thorough treatment, soak a soft cloth in mild soap solution and wipe surface in a light circular motion. Repeat with clean water. Allow to dry and polish with a soft dry cloth. Do not use detergents, aerosol sprays or other polishes.

Hard Surfaces

Wood Veneer Finishes: Waxing or polishing catalyzed finishes is not recommended because this will give a greasy, cloudy or uneven appearance to the product and could void your warranty. Global's conversion varnish is best cleaned by wiping the surface with a damp cloth, followed by a soft dry cloth in the direction of the grain. If the surfaces are heavily soiled, a gentle product like "Windex" can be used, following the same instructions as above.

Laminate & Painted Metal Finishes: Using a soft cloth, simply wipe the surface with a mild soap solution or glass cleaner. Always use a dry cloth and circular motion to prevent streaks.

-
- **Water-Based Cleaner:** Spot clean, using the foam only from a water-based cleaning agent, such as a mild detergent or non-solvent upholstery shampoo product. Apply foam with a soft brush in a circular motion. Vacuum when dry. Pretest small area before proceeding.
 - **Solvent Cleaner:** Spot clean, using a mild water-free solvent or dry cleaning product. Clean only in a well-ventilated room and avoid any product containing carbon tetrachloride or other toxic materials. Pretest a small area before proceeding.
 - **Water/Solvent Cleaner:** Spot clean with a mild solvent, an upholstery shampoo, or the foam from a mild detergent. When using a solvent or dry cleaning product, follow instructions carefully and clean only in a well-ventilated room. Avoid any product that contains carbon tetrachloride or other toxic materials. With either method, pretest a small area before proceeding.
 - **Vacuum Only:** Clean this fabric only by vacuuming or light brushing to prevent accumulation of dust and grime. Water-based foam cleaning agents of any kind may cause excessive shrinking, staining, or distortion of the surface pile and therefore, should not be used.
 - **Crypton Cleaning:** Generally stains are removed with plain water and powdered enzyme detergent. Upholstery foam shampoo, water-based cleaning products and germicidal detergents can be used. Be sure to remove all residue from cleaning products with clean water. Do not use solvent-based cleaners or dry cleaning products.
 - These recommendations and codes were developed by fabric specialists. However, because of the various ways fabric can be stained or damaged, there is no guarantee that the results will be completely successful. Use suggested methods on your own responsibility. To help prevent overall soil, frequent vacuuming or light brushing to remove dust and grime is recommended. Use professional furniture cleaning service when overall soiled condition has been reached.

TEXTILES & FINISHES

Textile Price Grades - Global Textiles

Grade 1	Drama, Hudson, Jenny, Mock Leather, Pebbles, Quilt, Sprinkle, Station, Terrace, Urban, Waterfall
Grade 2	Allante, Crescent, Cumulus, Imprint, Match, Oxygen, Quantum, Renewal, Replay, Silhouette
Grade 3	Couture
Grade 4	Non standard GLOBAL textiles
Grade 5	Leather/Mock Leather combination
Grade 6	Non standard GLOBAL textiles
Grade 7	Non standard GLOBAL textiles
Grade 8	Genuine Leather, Non standard GLOBAL textiles
Grade 9	Non standard GLOBAL textiles
Grade 11	Non standard GLOBAL textiles
Grade 10	Non standard GLOBAL textiles
Grade 12	Non standard GLOBAL textiles

Please refer to individual seating series for availability of a particular textile.

The charts above do not include Textiles offered by Alliance Partners: Arc-Com Fabrics, CF Stinson, Designtex, Knoll Textiles, Green Hides, LDI, Lumm Textiles, Maharam, Mayer Fabrics, Momentum, and Ultrafabrics.

Blend Seating Textiles

The grid below outlines the grade structure for using multiple textiles on select seating series. Blended textiles occur when one textile is chosen for one part of the chair and a different textile is selected for another part of the chair, resulting in a revised blended grade. For opportunities regarding more than two different textiles, please contact Global CustomerCare for approval process and grading.

FIRST TEXTILE SELECTED

		1	2	3	4	5	6	7	8	9	10	11	12	13	14	15	16	17	18		
SECOND TEXTILE SELECTED	1	1																			
	2	2	2																		
	3	3	3	3																	
	4	4	4	4	4																
	5	4	4	5	5	5															
	6	5	5	5	6	6	6														
	7	6	6	6	6	7	7	7													
	8	6	6	7	7	7	8	8	8												
	9	7	7	7	8	8	8	9	9	9											
	10	7	7	8	8	9	9	9	10	10	10										
	11	8	8	9	9	9	10	10	10	11	11	11									
	12	9	9	10	10	10	10	11	11	11	12	12	12								
	13	10	10	11	11	11	11	12	12	12	12	13	13	13							
	14	11	11	12	12	12	12	12	13	13	13	13	14	14	14						
	15	12	12	13	13	13	13	13	13	14	14	14	14	15	15	15					
	16	13	13	13	14	14	14	14	14	14	14	15	15	15	16	16	16				
	17	14	14	14	14	15	15	15	15	15	15	16	16	16	16	17	17	17			
	18	15	15	15	15	15	16	16	16	16	16	16	17	17	17	17	18	18	18		

Textile and Color Listings

Grade 1

Drama 65% Olefin / 35% Polyester

D801 Grey	D802 Dusk	D803 Navy Blue	D804 Black	D805 Burgundy	D806 Sage	D807 Beige
D808 Denim Blue	D809 Wheat	D810 Tan				

Hudson 100% Post-Consumer Recycled Polyester

HD02 Cordovan	HD03 Ruby	HD04 Orange	HD05 Wheat	HD06 Meadow	HD07 Coffee	HD08 Grey
HD09 Mocha	HD10 Thyme	HD11 Carbon	HD12 Midnight	HD13 Ocean	HD14 Cerulean	

Jenny 100% Polyester

JN01 Midnite	JN02 Ebony	JN03 Slate	JN04 Russet	JN05 Canyon	JN06 Teal	JN07 Vermillion
JN08 Admiral	JN09 Spruce	JN11 Charcoal				

Mock Leather 100% Polyvinyl Chloride

550 Black	559 Chamois	570 Surf	571 Latte	572 Melon	573 Delta	576 Jade
574 Bronze	575 Rouge	577 Graphite	578 Chaps	579 Cabernet	591 Alpine	

Pebbles 100% Polypropylene

PB01 Clay	PB02 Fawn	PB03 Sea Side	PB04 Stone	PB05 Marine	PB06 Atrium	PB07 Rhapsody
PB08 Ocean	PB09 Asphalt					

Quilt 100% Polyester

QL10 Black	QL11 Charcoal Grey	QL12 Violet	QL13 Poppy	QL14 Navy	QL15 Marine	QL16 Wine
QL17 Mint	QL18 Forrest	QL19 Silver				

Sprinkle 68% Olefin / 32% Polyester

S101 Cabernet	S102 Plum	S103 Barley	S104 Copper	S106 Sapphire	S107 Jade	S108 Stone
S109 Cobalt	S110 Black	S111 Graphite				

Station 61% Recycled Polyester / 39% Polypropylene

SN81 Green Olive	SN82 Sterling Silver	SN83 New Silver	SN84 Wheat	SN85 Sand	SN86 Sapphire	SN87 Tomato
SN88 Copper	SN89 Marine	SN90 Night Time	SN91 Charcoal	SN92 Taupe	SN93 Milk Chocolate	

Terrace 70% Virgin Polyester / 30% Post-Consumer Recycled Polyester

TC60 Lotus	TC61 Tigerlily	TC62 Shadow	TC63 Cobble	TC64 Cherry Blossom	TC65 Bluebell	TC66 Apple
TC67 Haze	TC68 Cerise	TC69 Twilight	TC70 Wintergreen	TC71 Ironwork	TC72 Pine Cone	TC73 Flirt
TC74 Echo						

Urban 62% Recycled Polyester / 32% Polyester

UR10 Red Rose	UR11 Ocean Blue	UR12 Blue Bayou	UR13 Green Grass	UR14 Sandcastle	UR15 Beach Day	UR16 Boardwalk
UR17 Earth	UR18 Brown Ridge	UR19 White Sand	UR20 Granite Rock	UR21 Gravel Road	UR22 Black Coal	

Waterfall 60% Virgin Polyester / 40% Post-Consumer Recycled Polyester

WA40 Trance	WA41 Tryst	WA42 Splash	WA43 Victoria	WA44 Imagine	WA45 Sky	WA46 Rainforest
WA47 Rumble	WA48 Prism	WA49 Tranquility	WA50 Grand	WA51 Rushing	WA52 Magestic	WA53 Pacific
WA54 Dance						

Grade 2

Crescent 100% Nylon with Teflon Designed to color coordinate with Renewal and Quantum fabrics.

700 Cocoa	701 Pear	702 Silver	703 Oatmeal	704 Lemon	705 Flame	706 Stem
709 Ruby	789 Raven	790 Cobalt Blue	792 Cinder Grey	799 Pine	800 Arctic	

Cumulus 60% Recycled Polyester / 40% Rayon with Teflon Designed to color coordinate with Oxygen and Silhouette fabrics.

CU80 Cinnamon	CU81 Sepia	CU82 Ginger	CU83 Steamboat	CU84 Coffee	CU85 Flora	CU86 Raven
CU87 Cyan	CU88 Foliage	CU89 Port				

Imprint 100% Post-Consumer Polyester

IM70 Almond	IM71 Cork	IM72 Sand	IM73 Currie	IM74 Candy Apple	IM75 Ocean	IM76 Navy
IM78 Celery	IM77 Green Tea	IM79 Oregano	IM80 Walnut	IM81 Paprika	IM82 Graphite	IM83 Slate
IM84 Licorice						

Match 100% Recycled Polyester

MT20 Desert	MT21 Sand	MT22 Moss	MT23 Orange	MT24 Sunset	MT25 Blue	MT26 Wave
MT27 Green	MT28 Chocolate	MT29 Burgundy	MT30 Grey	MT31 Quarry	MT32 Black	MT33 Arctic

TEXTILES & FINISHES

Grade 2 (continued)

Oxygen 60% Recycled Polyester / 40% Rayon with Teflon Designed to color coordinate with Cumulus and Silhouette fabrics.

OX01 Cabernet	OX02 Lime	OX03 Verde	OX04 Navy	OX05 Royal	OX06 Chestnut	OX07 Wine
OX08 Nutmeg	OX09 Sable	OX10 Nero				

Quantum 60% Recycled Polyester / 40% Rayon with Teflon Designed to color coordinate with Crescent and Renewal fabrics.

QU20 Cinder	QU21 Copper	QU22 Carmel	QU23 Cantaloupe	QU24 Paprika	QU25 Blue Haven	QU26 Forest
QU27 Raspberry	QU28 Azure	QU29 Marbles				

Renewal 70% Nylon / 30% Recycled Polyester with Teflon Designed to color coordinate with Crescent and Quantum fabrics.

RN30 Pewter	RN31 Cork	RN32 Cherry Fields	RN33 Volcanic Ash	RN34 Thunderstorm	RN36 Blue Grass	RN38 Leaf
RN39 Melon	RN40 Blueberry	RN41 Blue Bayou	RN44 Tomato	RN45 Amethyst	RN47 Ochre	

Replay 100% Post-Consumer Recycled Polyester

RP20 Taupe	RP21 Caramel	RP22 Paprika	RP23 Wine	RP24 Ocean	RP25 Navy	RP26 Pistachio
RP27 Moss	RP28 Turquoise	RP29 Teal	RP30 Autumn	RP31 Dark Chocolate	RP32 Slate	RP33 Dove
RP34 Coal						

Silhouette 100% Nylon with Teflon Designed to color coordinate with Cumulus and Oxygen fabrics.

SL20 Asphalt	SL21 Acorn	SL22 Indigo	SL23 Shiraz	SL24 Verdant	SL25 Bronze	SL26 Camel
SL27 Jade	SL28 Sienna	SL30 Charcoal	SL32 Claret	SL35 Hunter	SL36 Sapphire	

Grade 2 (Vinyl) For availability of chair series in Vinyl, please contact a Global Sales Representative.

Allante 100% Vinyl Face / 100% Polyester Backing

A01E Cadet	A02E Light Neutral	A03E Charcoal	A11E Regimental Blue	A13E Galaxy	A17E Burgundy	A18E Wine
A19E Nu-Red	A21E Elephant	A22E Cinnamon	A23E Beach Wood	A24E Teak	A25E Light Sand	A26E Cream
A27E Medium Beige	A29E Light Sandlewood	A31E Light Parchment	A32E Sea Oyster	A33E Espresso	A35E Medium Neutral	A36E Nu-Antelope
A38E Dark Pewter	A40E Nu-Shale	A41E Grey	A42E Bisque	A43E Black	A44E Ash	A45E Medium Grey
A46E Pearl Grey	A48E White	A49E Tundra	A50E Harvest	A51E Magnolia	A52E River Blue	A53E Meadow
A54E Hideaway	A55E Sea Cruise	A56E Reef	A57E Parrot	A58E Khaki	A50E Tumbleweed	A60E Cayenne
A61E Butterscotch	A62E Twine	A63E Mango				

Grade 3 (Recycled)

Couture 100% Post-Consumer Polyester

CE70 Champagne	CE71 Mocha	CE72 Pecan	CE73 Raspberry	CE74 Sapphire	CE75 Neptune	CE76 Lake
CE77 Willow	CE78 Sassy	CE79 Fudge	CE80 Persimmon	CE81 Carbon	CE82 Sterling	CE83 Peat

Grade 5

Genuine Leather/Mock Leather combinations 100% Leather / 100% Polyvinyl Chloride

450/550 Black	459/559 Chamois	470/570 Surf	471/571 Latte	472/572 Melon	473/573 Delta	474/574 Bronze
475/575 Rouge	476/576 Jade	477/577 Graphite	478/578 Chaps	479/579 Cabernet	491/591 Alpine	

Grade 8

Genuine Leather 100% Leather

450 Black	459 Chamois	470 Surf	471 Latte	472 Melon	473 Delta	474 Bronze
475 Rouge	476 Jade	477 Graphite	478 Chaps	479 Cabernet	491 Alpine	

Panel Fabrics

Grade 1

Agate II 100% Polypropylene

AG21 Bamboo AG22 Linen AG24 Slate AG25 Grey AG27 Mauve

Grade 2

Coordinate 100% Polyester *Fabric Grades are different when used on eO+ and GPS II panels. Please refer to 2017 Desking list price book for details.*

GN31 Sand GN32 Stone GN33 Mint GN34 Sky GN35 Beige GN36 Grey GN37 Olive
GN38 Blue GN39 Cactus GN40 Cinder GN41 Sage GN42 Brick

Lola 100% Polyester Designed to color coordinate with Brinx and Mariposa panel fabrics.

LL11 Medium Taupe LL12 Caramel Cream LL13 Straw LL14 Blue Mist LL15 Zucchini LL16 Natural LL17 Cafe Au Lait
LL18 Mortar LL19 Black

Grade 3

Accent 100% Polyester *Fabric Grades are different when used on eO+ and GPS II panels. Please refer to 2017 Desking list price book for details.*

GC31 Sand Dune GC32 Limestone GC33 Silver Mint GC34 Skyway GC35 Warm Beige GC36 Mid-Grey GC37 Green Olive
GC38 Cloud Blue GC39 Desert Cactus GC40 Cinder Block GC41 Sage Brush GC42 Brickworks

Brinx 100% Polyester Designed to color coordinate with Lola and Mariposa panel fabrics.

BX01 Taupe BX02 Caramel BX03 Green Apple BX04 Brick BX05 Blue Steel BX06 Bisque BX07 Hot Chocolate
BX08 Golden

Mariposa 100% Polyester Designed to color coordinate with Lola and Brinx panel fabrics.

MA41 Mocha MA42 Blue Ocean MA43 Claypot MA44 Champagne MA45 Granny Smith MA46 Butterscotch MA47 Mixed Taupe MA48
Wheat

Finishes

Seating Finishes - Metal: *Please consult each Seating Series for finish availability.*

Black (BK) Charcoal Grey (CHR) Chorme (CH) Fog (FG) Polished Aluminum (ALU) Tungsten (TUN)

Seating Finishes - Plastic *(Duet, Popcorn, and Sonic)*

Asphalt Night (BLK) Caribbean Surf (CRS) Coffee Bean (CFB) Daffodil Day (DFD) Ivory Clouds (IVC) Latte Beige (LAB) Lip Smacker (LPS)
Platinum (PLT) Sea Glass (SEG) Tiger Orange (TIO)

Seating Finishes - Wood *Seating finishes will not necessarily match Casegoods finishes. This is due to the fact that Seating and Casegoods finishes use different wood species and are manufactured at multiple locations.*

Absolute (AAM) Black (BKM) Cherry (ACM) Espresso Cafe (ECM) English Oak (EOM) Fruitwood (TFM) Gray (HGM)
Honey (AHM) Mahogany (TMM) Maple (AVM) Medium Walnut (MWM) Night (ASM) Shaker Cherry (SKM) Walnut (TWM)
WC Cream (WTM) White (WHM) Winter Cherry (WCM)

Desks, Workstations, Tables and Accessories - Laminate

Absolute Acajou (ACJ) Asian Night (ASN) Avant Cherry (AWC) Avant Honey (AWH) Black (BLK) Brushed Cobalt (BRC) Constellation Java (CSJ)
Dark Espresso (DES) Grey (GRY) Hayden Grey (HGT) Quartered Mahogany (QTM) Shaker Cherry (SKC) Storm Grey (SOG) Tiger Fruitwood (TFW)
Tiger Mahogany (TMA) Tiger Maple (TMP) Tiger Walnut (TWL) White (WHT) White Chocolate (WHC) Willow Grey (WGY) Winter Cherry (WCR)

Desks, Workstations, Tables and Accessories - Veneer Wood

Almond Cherry (AMW) Caramel Bamboo (BAMC) Cocoa Walnut (CAW) Coral (CRW) Dark Cherry (DCW) Espresso Walnut (EWW) Evening Oak (EVW)
Grey on Oak (GRW) Hazelnut (HAW) Honey Maple (SMW) Java (JAW) Latte Walnut (LTW) Milestone (MTW) Mocha (MCW)
Natural Maple (MPW) Red Cherry (RCW) Vintage Cherry (VNW) Walnut (WLW) Warm Cherry (WCW) White Maple (WMW)

File Finishes - Standard

Black (BLK) Business Grey (BGR) Charcoal Grey (CGR) Desert Putty (DPT) Grey (GRY) Light Grey (LGR) Nevada (NEV)
Storm Grey (SGR) Tahiti Sand (TSA)

File Finishes - Premium

Bone (F29) Claret (F09) Cloud (F23) Designer White (DWT) Ice (F33) Ivory (F30) Metro (F07)
Moss (F05) Navy (F19) Oyster (F35) Stone (F32) Tungsten 2 (TU2) Willow (F28)

File Finishes - Textured

Black Coffee (U04) Dark Chocolate (T19) Cappuccino (T20) Mocha (J52) Vanilla (J23)

THINK GLOBAL/THINK GREEN



LEVEL 3 CERTIFIED
Many programs in various categories



LEED PARTNERSHIP PROGRAM
Products can help you earn credits



GREENGUARD CERTIFIED
Children & Schools Certified

THE ENVIRONMENT We believe now more than ever, that it is our responsibility to protect the environment and our precious natural resources for future generations. The growing importance of energy and environmental concerns continues to challenge us in this ever changing marketplace.

As an industry leader, Global continues to take proactive steps towards reducing the negative impacts on the environment. We are building "healthier" offices; investing in Research & Development and new technologies; reducing waste and the consumption of energy; and improving the quality of the air we breathe, all which can have a significant impact on our quality of life.



Epoxy Powder coating process is solvent free. No harmful VOC's or lead. No toxins are released into the atmosphere.

Global's recycled fabrics offer affordable, environmentally responsible alternatives to commercial textiles. We recycle 35,000 lbs of fabric offcuts weekly.



powder paint process:
98% paint recovery and reuse

more recycled fabric
less to the landfill

talk to us about our
leed partnership program

we've diverted
90% of our wood waste from landfill in four years



Global has the products and resources to help your projects achieve LEED certification.

New technology allows us to reduce glue usage by 50%. In addition, our polyurethane glue reduces emissions and requires less energy to apply.

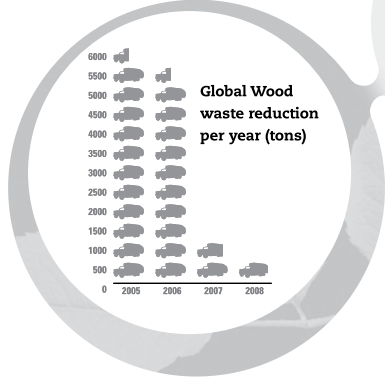

For further information on Global's environmental initiatives, please visit <https://www.globalfurnituregroup.com/us/company/environmental-commitment>

CUSTOM GROMMET LOCATION FORM

Model # _____ (Please use one page for each model #)

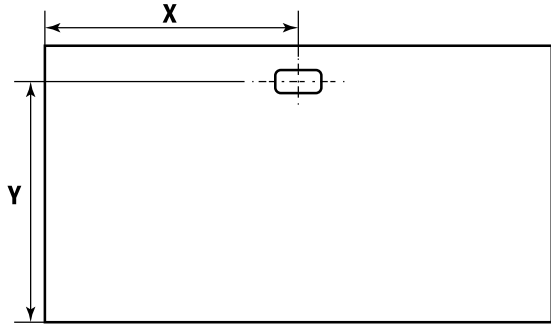

Operator Side

Template for Tops

X = _____

Y = _____

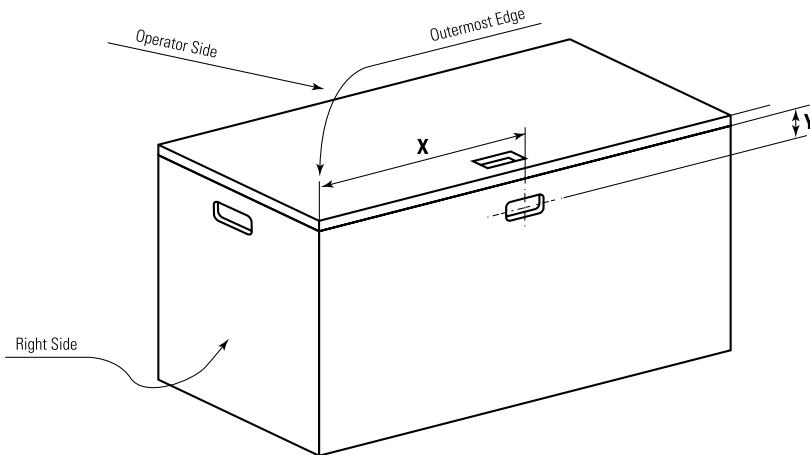
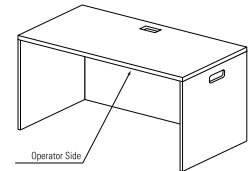

Template for Modesty Panels

X = _____

Y = _____

Note: X = Taken from outermost edge

Note: Y = Taken from underside of top

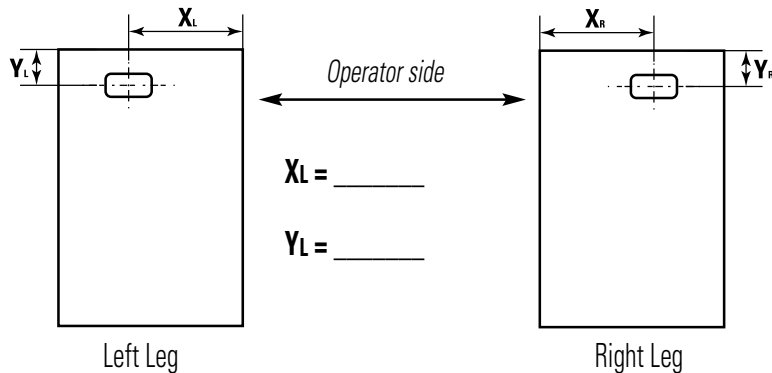

Left Leg

Right Leg

Template for Legs

XR = _____

YR = _____

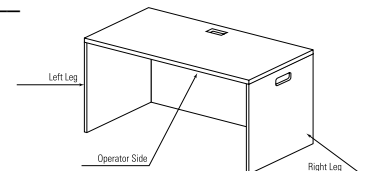

CUSTOM COLOR APPROVAL FORM - GLOBAL WOOD VENEER DESKS AND TABLES

Dufferin and Lufton series only

Dealer will be billed a matching fee of \$375 upon receipt of the match sample.

All standard products with a custom stain receive a 15% upcharge.

Please complete the form below and mail it, along with TWO samples (no smaller than 3" x 3") to:

Global - The Total Office
ATTN: Casegoods - Custom Stain Match
17 West Stow Road, PO Box 562
Marlton, NJ 08053

CONTACT INFORMATION

Date:	Project Name:		
A+D/Dealer/Company Name:	Contact Name:		
Billing Address:	Phone:		
City:	State:	Zip:	E-mail:

CUSTOM STAIN INFORMATION

Manufacturer's Name: _____

Color Name: _____

Color Code: _____

Comments / Sample to be matched on (species): _____

INTERNAL USE ONLY

Sample Received on:	VMID:
Special Finish Upcharge:	Color #:
Wood Species:	

PLEASE FILL OUT THE SECTION BELOW ONCE SAMPLE HAS BEEN RECEIVED AND APPROVED. SUBMIT THIS PAPERWORK WITH THE ORDER.

APPROVED: YES NO DATE: _____

SIGNATURE _____

PRINT NAME _____

PO # _____

LUFTON & DUFFERIN TACKBOARD C.O.M. AUTHORIZATION FORM

(Use for tackboards found in veneer price book only)

CUSTOMER INFORMATION

A+D/Dealer/Company Name: _____ Contact: _____

Billing Address: _____ Phone: _____

City: _____ State: _____ Zip: _____ Fax: _____

End-User/Project Name: _____ End-User/Project Registered? YES NO If YES, The Global Quote#: _____

Local Global Distribution Center: _____ Date: _____

TEXTILE INFORMATION

Mill or Manufacturer's Name: _____

Textile Name (Series/Style #): _____

Textile Color Name and Description: _____

Textile Content (% Cotton, % Poly, % Wool, etc.): _____

Designer or Specifier of Textile: _____

Textile Width: _____ Pattern Repeat: VERTICAL HORIZONTAL Rail Roaded? YES NO

PRODUCT INFORMATION			
QUANTITY	MODEL	FABRIC DIRECTION - HORIZONTAL / VERTICAL	YARDAGE REQUIRED PER PANEL

USE A SEPARATE FORM FOR EACH FABRIC REQUESTED.
STAPLE SAMPLE TO THIS FORM IN THE DIRECTION YOU WOULD LIKE IT APPLIED TO THE PANEL
ONCE THE FABRIC HAS BEEN APPROVED AND/OR AN AUTHORIZATION NUMBER HAS BEEN ISSUED, A SET OF FORWARDING INSTRUCTIONS (FOR THE TEXTILE) WILL BE E-MAILED TO YOU. DO NOT SEND ANY FABRIC WITHOUT THESE DOCUMENTS AND THE COM AUTHORIZATION NUMBER!

MAIL FORM TO:
 Global - The Total Office
 C/O Descor Industries
 15 Riviera Drive
 Markham, ON L3R 8N4

INTERNAL USE ONLY

QUOTE #: _____ PRODUCTION TIME: _____

NOTES: _____

TERMS & CONDITIONS

This illustrated price list has been designed to facilitate fast reference and easy use. All products are categorized into "seating", "desks", "files", "panels", "tables" and "modular furniture", and are listed numerically within their categories. The line drawings match actual photographs (where possible) to aid in instant recognition of the total range within a series.

Sales of Global-The Total Office ("Global") products are made only on Global's standard terms and conditions of sale which are contained in this Price Book. These standard terms and conditions may be modified or supplemented only by a separately written document signed by Global's authorized personnel at its head office in Marlton, NJ. Any term or condition contained in any purchase order or other form used by dealer/purchaser to order goods (including standard, printed language) which is different from, in addition to, or in any way inconsistent with Global's standard terms and conditions shall be of no force or effect whatsoever.

All illustrations, specifications and prices in this book are based on the latest product information available at the time of publication. Global reserves the right to make changes, at any time and without prior notice, to prices, colors, materials, specifications and models offered.

Description

Each product shown or described in this price list is standard Global product. Variations are noted at the beginning of each series. Any variations from what is standard may require additional delivery time and cost and may affect the warranty given. Sizes and weights shown are approximate and are subject to slight changes from time to time.

Prices and Payment

The prices shown in this book, as well as those quoted by Global, are in United States dollars for orders shipped to destinations in the U.S. and Mexico.

If shipping date requested is more than 90 days from date of order, Global shall have the right to use published list prices effective at the time of shipment.

Orders are invoiced at the time of shipment. Terms of payment are net 30 days from date of invoice (1% 15 days) unless otherwise stated. The customer agrees that Global shall have the right to enforce a charge amounting to 1.5% per month (18% per year) on invoices outstanding more than 30 days.

If dealer/purchaser's most recent annual net volume is less than \$5,000.00, payment must be made in advance.

Any products sold by Global shall remain the personal property of Global until fully paid.

Prices are suggested list prices only and are subject to change without notice. Global will, however, attempt to keep dealer/purchasers up-to-date on all developments including price changes.

Taxes

All prices shown in this book are exclusive of sales, use, excise and other applicable taxes and are the dealer/purchaser's responsibility as per the invoice issued by Global. If dealer/purchaser claims an exemption from such taxes, it shall be the dealer/purchaser's responsibility to furnish Global with an appropriate exemption certificate at time of order.

Ordering Information

To avoid errors and/or duplication Global requires that all orders be submitted in writing. All orders submitted to Global in writing will be acknowledged on Global's acknowledgement forms governing the transaction. The details appearing on this acknowledgement will describe the items to be shipped and the approximate shipping date. It is the dealer/purchaser's responsibility to determine that the information in the acknowledgment is correct. In the event of an error, the dealer/purchaser must notify Global immediately by telephone followed by written confirmation. Shipping dates are assigned to orders based on the item having the longest manufacturing lead time.

When ordering, please provide the following information:

- 1) Account number (if possible)
- 2) P.O. number
- 3) "Bill to" and "ship to" name and address
- 4) Complete model number
- 5) Description
- 6) Options:
 - a. Upholstery fabric type and color (specify by name and number)
 - b. Color of paint finish, laminate or wood (if applicable)
 - c. Trim options (frame)
 - d. Arms
 - e. Base, Casters
 - f. Mechanism
 - g. Accessories

Dealer/purchaser is responsible for providing correct information when placing an order. Orders with incorrect information (finish, etc.) will be scheduled for manufacturing upon receipt of complete information.

All phone orders must be confirmed in writing by the customer within 7 days.

To prevent a delay in processing orders, please specify delivery routing.

Changes and Cancellations

After the date of Global's acknowledgment of a dealer/purchaser's order, the order may not be changed or cancelled by dealer/purchaser without the written consent of Global. Special order items, C.O.M. and fabric-covered items already in production are not subject to change or cancellation under any circumstances. Fabric-covered items are considered to be in production once the fabric is scheduled for cutting. Other standard items already in production are subject to a minimum 35% cancellation charge.

Errors and Omissions

All quotations, acknowledgements and invoices are subject to corrections for any errors and omissions.

FINISHES

Seating Finishes

Where painted frames are not a standard color, there is a one time charge of \$578.00 list price per-order for custom wood staining/color matching. Restrictions may apply. The customer must provide a 3" x 3" color chip/sample. Non-standard finishes must be approved by Global prior to acceptance of order.

File Finishes

All non-standard finishes must be approved by Global prior to acceptance of order and may be subject to an upcharge.

Laminated Tops - Pricing for all non-standard finishes and sizes must be provided by Global Customer Service and may be subject to an upcharge.

Desk Finishes

Because the distinctive characteristics and the nature of wood products cause variations, exact matches are not always possible.

Global has launched a finishes program between marketing companies within the Global Group to match products as best as possible when same finishes are specified.

C.O.M. (Customers Own Material)

Use of Customer's Own Material must be approved by Global prior to acceptance of order. Please refer to page 348 of the Price Book and fill out the Authorization Request Form. Photocopy and use this form as often as necessary. The customer must provide a 12" x 12" fabric sample and advise how the fabric is to be applied. **Fabric yardage requirement will be advised by the factory, and additional yardage may be required if pattern requires matching.** Yardage shown in the List Price Book does not allow for pattern repeat/matching. Send to the address provided on shipping document upon approval from Global. If C.O.M. is difficult to apply or if product shall be modified, extra charges shall be made. Global reserves the right to cancel an order at any time if C.O.M. is inadequate for any reason. Customer's Own Material must be shipped freight and duties paid to our factory. Such shipment must be fully identified with purchaser's order number, RGA # provided by Global, and the item for which material is intended. Performance of C.O.M. when applied to product is the sole responsibility of the purchaser. Global's standard product warranty shall not apply to C.O.M. Use of C.O.M. will not reduce the published list price.

Textile Grading

All products are priced according to their standard fabric and fabric grade. Lower grade fabrics are available (unless otherwise specified) at same price as standard.

The listing of prices for each model indicates the prices for higher upholstery grades. Prices are based on yardage in imperial measurements.

TEXTILE PRICE GRADES - GLOBAL TEXTILES

Grade	Upholstery (Seating Fabrics)
1	Drama, Hudson, Jenny, Mock Leather, Pebbles, Quilt, Sprinkle, Station, Terrace, Urban, Waterfall
2	Allante, Crescent, Cumulus, Imprint, Match, Oxygen, Quantum, Renewal, Replay, Silhouette
3	Couture
5	Leather/Mock Leather Combination
8	Genuine Leather

Grade Upholstery (Panel Fabrics)

1	Agate II
2	Coordinate, Lola
3	Accent, Brinx, Mariposa

The charts above do not include Textiles offered by Alliance Partners: Arc-Com Fabrics, CF Stinson, Designtex, Knoll Textiles, Green Hides, LDI, Lumm Textiles, Maharam, Mayer Fabrics, Momentum, and Ultrafabrics.

Upholstery Coverings

Slight variations in color may occur between dye lots. Although Global attempts to minimize these variances, they do occur and must be accepted as normal and will not be considered defects.

Yardage

Required yardage (ydg) is based on unmatched materials with widths of 54" for seating, 63" for GPS panels. Yardage calculations are based on imperial measurements.

Arms

A wide selection of arms are available for some series. See Arm Charts for details.

Delays

Global's shipping confirmation will state a shipping date which is Global's best estimate at the time the order is acknowledged. However, Global shall not incur any obligation or liability to Purchaser for failure to ship by specified date unless Global has agreed to an unequivocal shipping date in a separately signed written document executed by its authorized personnel at its head office. In addition, Global shall not be liable for any loss or damage resulting from any delay or failure in shipment or other failure to perform all or any part of the agreement between the parties with respect to the goods shown on the face of the order acknowledgement where such delay, failure, loss or damage is the proximate result of any act of any governmental authority or political subdivision thereof, revolution, riot, civil disorder or disturbance, delay or default in transportation, strike disputes among or between labor unions or other labor disputes, delay or inability in obtaining materials and facilities, fire, flood, act of God or any cause not within the reasonable control of the company, whether of the class of causes enumerated or otherwise.

F.O.B.

F.O.B. point is Global's Factory, Downsview, Ontario, Canada, or any Global Regional Distribution Center.

UPS Shipments

Seating products marked with a UPS symbol are packaged for UPS-able shipments.

Handling

A \$25. net handling charge per shipment will be applied for non UPS-able orders of less than \$2000. list.

Special Delivery Requirements

Global's delivered pricing provides for dock delivery during normal business hours (considered to be 8 am to 4 pm Monday through Friday) to customer/end user only. Additional delivery requirements such as inside delivery, lift gate, limited access sites, installations and weekend deliveries will incur an additional expense and will be the responsibility of the dealer.

Service

Service requests are normally the responsibility of Global's authorized dealers. Where this cannot be accomplished on a local level, service problems should be referred to Global's Customer Service Department in the nearest distribution center.

Returns

No returns of goods will be accepted without written consent and shipping instruction of Global. A minimum re-stocking charge of 35% is made on all authorized returns for credit or refund, provided goods are received by Global in the condition in which they left the factory. This

may increase depending on the type of product. Global's Return Goods Authorization (R.G.A.) numbers must appear prominently on all authorized returns. Global will not be responsible for freight costs. No credit will be given if goods cannot be reused as new. Special order items, non-stock items and C.O.M. products are in no event subject to return. All returns must be approved and authorized in writing by Global Customer Service. Global reserves the right to refuse delivery of any unauthorized returns.

Claims

All goods are sold F.O.B. plant or Global Distribution Center. Global is not responsible for damage which occurs in transit (or in storage). The carrier signs for all goods received in apparently good order. It is the dealer/purchaser's responsibility to examine goods upon receipt and to file any claims with the carrier for losses or damage to the product occurring during transit, including concealed damage.

Any claims made against Global for apparent defects, errors or shortages must be made by the dealer/purchaser, in writing, within 15 working days after any delivery. Failure by the dealer/purchaser to make any claim against Global within 15 days shall constitute acceptance of the goods and a waiver of any apparent defects, errors or shortages.

Suspension

In the event that the dealer/purchaser defaults in the payment of any sum due to Global, or in the event the dealer/purchaser's financial condition becomes unsatisfactory to Global, Global shall have the right to defer or discontinue shipment of any goods until such time as the default is cured or the dealer/purchaser provides assurance of payment to Global.

Copyright

All catalogs, photographs, drawings, price lists and other printed material are protected by copyright. All rights reserved.

Trademarks

All trademarks are owned by Global Total Office other than OBUSFORME™ which is owned by OBUSFORME LTD. and are used under license. OBUSFORME® and the distinctive backrest design are registered trademarks of OBUSFORME LTD.

Designs and Patents

Many of the products produced by Global are protected by design registrations, design patents and/or patents. Design and specifications are subject to change, discontinuance or additions without notice.

Cubic Measure

The stated cubage is an approximate cubic foot measure to calculate freight costs. The figure shown is the volume for one carton and is subject to change without notice. It is most economical to purchase the specified number per carton.

Combined Shipments

Global will make every effort to combine shipments and orders on written request. However, Global cannot be held responsible where such request is not complied with.

Offer of Sale

Possession of this price list or any other literature shall not imply the company's willingness to sell to the holder and shall not be construed as a direct offer of sale.

If a conflict arises between: (i) prices found in software support packages furnished to the customer by Global or by any other source on behalf of Global; and (ii) Global's current printed price lists, then the most current shall prevail.

Disclaimer

All dimensions are in inches. Prices shown are current manufacturer's suggested list prices at the time of printing. All applicable taxes are extra. Descriptions, specifications and prices are subject to change without notice. Errors and omissions are subject to correction.

Flammability

The foam used in Global chairs meets the requirements of California TB117. In addition, a number of Global seating models can be certified to California TB133. This available certification can be done when selected seating models are upholstered in specific fabrics. The list of certifiable seating models and available fabrics changes from time to time. Please contact Customer Service for a list of certifiable models and upholstery materials.

Special CAL 133 Upcharges

All plastic series/models within the Duet, Popcorn, and Sonic series do not have an upcharge (\$0). All Vion models with mesh backs require a \$150 list upcharge. All Softcurve models require a \$209 list upcharge. Please see Chart below for additional upcharges on products that can be certified to California TB133.

This list price book is effective as of January 1st, 2017.

For periodic updates, please check the PDF at www.globalfurnituregroup.com. After login, select INFORMATION, then GLOBAL, and then PRICE BOOK/PRICING. Global warrants that all commercial products are free from defects in material and workmanship, for the life of the product, to the original purchaser.

CAL 133 UPCHARGES

PRODUCT CATEGORY	SERIES	FABRIC	VINYL	LEATHER
Plastic Stacking/Nesting w/ Upholstered Pad(s)	All Series	\$74	\$74	\$74
Guest, Task, Management, Conference, Executive	All Series	\$110	\$110	\$110
Lounge — Single Seat	All Series	\$209	\$209	\$209
Lounge — 2 Seate	All Series	\$314	\$314	\$314
Lounge — 3 Seater	All Series	\$418	\$418	\$418

LIFETIME WARRANTY

Global will repair or replace, at Global's option, as the sole remedy for any defect covered by the warranty. The warranty applies to products manufactured after January 1, 2011.

General Commercial Seating

Global's warranty for general commercial seating covers all chair components including pneumatic cylinders, bases, casters, glides, frames, arms, plastic seats, backs and other structural components.

Exceptions to the warranty for general commercial seating are as follows:

- Foam, textiles (as sampled on Global branded and textile program cards), mesh material and electrical devices, are warranted for five (5) Years
- Control mechanisms are warranted for twelve (12) Years

The warranty applies to single shift, standard commercial usage, defined as a standard eight (8) hour day, forty (40) hour week for users weighing up to 300 pounds. ObusForme Comfort XL falls under the General Commercial Seating Warranty with the exception the weight rating is for users up to 400 pounds.

Heavy Duty Seating

Global offers products designed for multiple shift applications (24 hours a day / 7 days a week) and larger individuals weighing up to 350 and/or 500 pounds (depending on series and/or model). Global warrants these products for twelve (12) years to the original purchaser. All components (including control mechanisms, pneumatic cylinders, bases, casters, glides, frames, arms, plastic seats/backs, etc.) are covered for 24/7 applications under the warranty. The exceptions are foam and textiles, which are covered for five (5) years. Textiles on these products must exceed 100,000 double rubs for the textile portion of the warranty to apply. Heavy Duty product series that apply under this warranty currently include: Concord Executive 24 hour, Dexter/Dexter+, Granada TS, Granada Deluxe TS, Malaga TS, Mallorca TS, Maxima II, ObusForme Comfort TS, Robust, Saxon, Stamina+, Truform TS, Vion TS and Yorkdale TS.

Light Use Seating

Global offers light use seating that is warranted for ten (10) years for the original purchaser. The warranty covers all components (frames, glides, and arms). The foam/textiles are warranted for five (5) years. The warranty on these light use series is for an eight (8) hour day, forty (40) hour week for users up to 200 pounds. Light use product series that apply under this warranty currently consists of Key series.

Textiles

Global warrants Global branded textiles and Alliance Partner carded textile programs inclusive of fabrics, vinyls and leather products for five (5) years. Alliance Partner carded textile programs are currently with Arc-Com Fabrics, CF Stinson, Designtex, Knoll Textiles, Green Hides, LDI, Lumm Textiles, Maharam, Mayer Fabrics, Momentum, and Ultrafabrics. Global does not warrant COM (Customer Own Materials) or graded-in materials (non-carded) and purchased by Global for a customer. For graded-in or COM products, please contact the textile supplier for performance information and warranty details.

Seating Warranty Summary

Seating Type	Components Warranty For Original Purchaser	Use Time For Warranty Coverage	Exceptions
General Commercial Seating	Lifetime	8 Hours/5 Days Per Week	Foam/Textiles/Mesh/Electrical Devices - 5 Years Control Mechanisms - 12 Years
Heavy Duty Seating	12 Years	24 Hours/7 Days Per Week	Foam/Textiles - 5 Years
Light Use Seating	10 Years	8 Hours/5 Days Per Week	Foam/Textiles - 5 Years

Files, Desks, Modular Furniture, Tables, Panels & Accessories

Global warrants all components of metal storage and filing, laminate and wood veneer desks, laminate and wood veneer tables, metal leg components and panels for the lifetime of the product to the original purchaser.

Exceptions to the warranty for Files/Desks/Tables and Panels are as follows:

- Electrical devices, panel and tackboard textiles, adjustable keyboard mechanisms/lecterns/coat trees and task lights – five (5) Years
- Folding tables (laminate and Lite Lift II models) – one (1) Year

Files, Desks, Modular Furniture, Tables, Panels & Accessories Warranty Summary

Product Type	Components Warranty For Original Purchaser	Exceptions
Metal Storage and Filing	Lifetime	None
Laminate/Wood Veneer Desks and Modular Furniture	Lifetime	Tackboard Textiles , Electrical Devices,Task Lights - 5 Years
Productivity Solutions - Foli Height Adjustable Tables	Lifetime	Steel components - 10 Years, Moving components - 5 Years, All electrical components - 2 Years
Boardroom, Conference and Training Tables	Lifetime	Electrical Devices - 5 Years
Panels	Lifetime	Panel Textiles, Electrical Devices, Task Lights - 5 Years
Coat Racks and Lecterns	5 Years	None
Folding Tables (Laminate & Molded)	1 Year	None

Global's Warranty does not apply (for any product category) to the following:

- Failures due to wear and tear
- Failures which result from negligence, abuse, accident or misuse
- Failure to apply, install or maintain products according to Global's written instructions and warnings
- Modifications, attachments or repair methods not approved by Global
- Damage caused by a carrier in transit, or delivery/installation contractors
- The matching of colors, grains or textures (wood, leather, etc.) of natural materials and color matching of textiles
- Products exposed to extreme hot or cold temperatures or excessively dry or humid environments
- Colorfastness or the matching of color of textiles
- Damage by markings or staining; damage by sharp objects or imprinting from instruments
- Damage to textiles or laminate and wood surfaces/edges from exposure to sunlight (including UV rays)
- Products used for rental purposes

Global's warranty does not cover the costs of transportation or labor. Repair or replacement will be at Global's option.

Global makes no warranty that any of its products are suitable for any particular purpose and makes no other warranties, express or implied, other than those set out here. As codes and standards vary from one jurisdiction to another, references to compliance are solely for convenience and without any representation as to accuracy or suitability. Users must verify the suitability of such information or product for their specific application. In no event shall Global be liable in either tort or contract for any loss or direct, special, incidental, consequential, or exemplary damages.

Global's warranty applies to products sold within the United States of America, Mexico, the Commonwealth of Puerto Rico and Canada.

Global US Headquarters/Distribution Center

17 West Stow Road, P.O. Box 562
Marlton, New Jersey U.S.A. 08053
T (856) 596-3390
T (800) 220-1900
F (856) 596-5684

A \$25 net handling charge per shipment
will be applied for non-UPSable orders of
less than \$2,000 list.

Showrooms

Atlanta

10 10th Street
Suite 150
Atlanta, GA 30309
T (404) 879-0998
F (404) 879-9995

Boston

One Harbor Street
Suite 104
Boston, MA 02210
T (617) 406-5435
F (617) 406-5438

Chicago

The Merchandise Mart
10th Floor, Suite 1035
Chicago, IL 60654
T (312) 755-0843
F (312) 755-0837

Detroit Area

25925 Telegraph Road
Suite 145
Southfield, MI 48034
T (248) 357-7211
F (248) 357-7241

Ft. Lauderdale

Las Olas City Centre
401 East Las Olas Blvd.
Suite 230
Ft. Lauderdale, FL 33301
T (954) 763-2684
T (800) 331-0529
T (954) 763-6870

New York City

386 Park Avenue South
7th floor
New York, NY 10016
T (212) 545-9900
T (888) 315-1301
F (212) 545-5826

Philadelphia Area

119 Greentree Road
Marlton, NJ 08053
T (856) 596-3390
T (800) 220-1900
F (856) 596-4472

Phoenix

4675 E Cotton Center Blvd.
Suite 165
Phoenix, AZ 85040
T (602) 426-0666
T (602) 426-0777
F (602) 426-1148

St. Louis

5 Document Drive
St. Louis, MO 63114
T (314) 432-4463
F (314) 432-4471

Washington, DC

1130 Connecticut Avenue
10th Floor, Suite 1000
Washington, DC 20036
T (202) 659-0230
T (202) 659-0236
F (202) 659-0306

Distribution Centers

Atlanta Area

2124 Evergreen Blvd.
Duluth, GA 30096
T (678) 602-4130
T (800) 220-7328
F (678) 602-4136

Baltimore Area

Troy Hill Corporate Center
7030 Troy Hill Drive
Elkridge, MD 21075
T (410) 379-8021
T (800) 863-7300
F (301) 362-9444

Boston Area

19 Connector Road
Unit 1
Andover, MA 01810
T (978) 470-8463
T (800) 876-8980
F (978) 470-8920

Chicago Area

1879 Internationale Blvd.
Glendale Heights, IL 60139
T (630) 681-2818
T (800) 866-6497
F (630) 681-1631

Cincinnati Area

8712 LeSaint Drive
Fairfield, OH 45014
T (513) 777-0009
T (800) 552-3375
F (513) 777-5863

Dallas Area

2025 West Beltline Road
#100
Carrollton, TX 75006
T (972) 236-1366
T (800) 929-2936
F (972) 236-1372

Denver Area

16401 East 33rd Drive
Suite 50
Aurora, CO 80011
T (303) 340-1617
T (800) 275-6655
F (303) 340-1657

Ft. Lauderdale Area

560 Sawgrass Corp. Pkwy
Sunrise, FL 33325
T (954) 846-8888
T (800) 331-0529
F (954) 846-8110

Houston Area

7865 Northcourt Road
Building D, Suite 200
Houston, TX 77040
T (713) 695-5777
T (800) 935-6468
F (713) 695-5778

Los Angeles Area

12320 Bloomfield Avenue
Unit A
Santa Fe Springs, CA 90670
T (562) 484-9686
T (800) 640-0301
F (562) 484-9685

Minneapolis Area

2000 Freeway Boulevard
Brooklyn Center, MN 55430
T (763) 560-8196
T (800) 829-2153
F (763) 560-2098

New Orleans Area

901 South Labarre Road
Suite 201
Metairie, LA 70001
T (504) 834-6228
T (800) 275-0663
F (504) 835-9638

Pittsburgh Area

380 Leetsdale Industrial Dr.
Leetsdale, PA 15056
T (724) 385-1200
T (800) 942-9999
F (724) 385-1207

San Antonio Area

6950 Alamo Downs Pkwy
Suite 100
San Antonio, TX 78238
T (210) 684-8450
T (800) 683-4000
F (210) 684-3700

San Francisco Area

44091 Nobel Drive
Fremont, CA 94538
T (510) 897-4150
T (888) 418-4800
F (510) 897-4156

Seattle Area

Oakdale Commerce Ctr.
820 Southwest 34th Street
Building W7, Suite A
Renton, WA 98057
T (425) 291-9282
T (888) 218-2600
F (425) 291-9287

Kansas City Area

11617 West 81st Street
Lenexa, KS 66214
T (913) 310-9963
T (800) 796-0770
F (913) 310-9976

Tampa Area

10351 Windhorst Road
Tampa, FL 33619
T (813) 621-6272
T (877) 707-3966
F (813) 621-7958

